



MODERNA FIZIKA

Izbor povzetkov in interaktivnih vsebin
Študijsko gradivo

Kazalo vsebine

Relativnost 1: Transformacija prostora-časa

1.1	Uvod v moderno fiziko	7
1.2	Klasična relativnost	11
1.3	Michelson-Morleyev eksperiment	14
1.4	Posebna teorija relativnosti	15
1.5	Posledice posebne teorije relativnosti	19
1.6	Lorentzova transformacija	23

Relativnost 2: Kinematika

2.1	Transformacija hitrosti	25
2.2	Relativistični Dopplerjev premik	26
2.3	Relativistična gibalna količina	28
2.4	Relativistična energija	29
2.5	Vektorji četverci in invariante	30
2.6	Sistem delcev	31

Kvantna mehanika 1: Valovanje ali delci?

3.1	Uvod v kvantno mehaniko	34
-----	-------------------------	----

3.3	Svetloba – valovanje ali delci?	35
3.4	Atomska struktura snovi in Bohrov model atoma	43

Kvantna mehanika 2: Kvantnomehanski opis

4.1	Delčno-valovna dualnost materije	48
4.2	Valovni paket	50
4.3	Heisenbergovo načelo nedoločenosti	51
4.4	Valovna funkcija	52
4.5	Schrödingerjeva enačba	54

Kvantna mehanika 3: Gibanje v 1D

5.1	Delec v neskončni potencialni jami	56
5.2	Kvantni harmonski oscilator	58
5.3	Povprečne vrednosti opazljivk in operatorji	60
5.4	Razvoj valovnih funkcij	61
5.5	Potencialna stopnica	62
5.6	Potencialna plast	63



Kazalo vsebine

Kvantna mehanika 4: Gibanje v 3D

6.1 Centralne sile	68
6.2 Kvantni rotator	71
6.3 Atom vodika in njemu podobni atomi	72
6.4 Atomski magnetizem	75
6.5 Spin elektrona	77
6.6 Sklopitev spinske in tirne vrtilne količine	79
6.7 Zeemanov razcep	81
6.8 Atomi z več elektroni	85

Kvantna mehanika 5: Molekule

7.1 Povezovanje atomov v molekule in tipi vezi	87
7.2 Rotacijska in vibracijska vzbujena stanja molekul	90
7.3 Kvantnomehanski opis molekul	93

Statistična fizika

8.1 Maxwell-Boltzmannova porazdelitev	96
8.2 Kvantna statistika	100
8.3 Primeri uporabe kvantne statistike	104
8.4 Laserji	108

Trdna snov

9.1 Povezovanje atomov v trdni snovi	113
9.2 Določanje kristalne strukture	117
9.3 Pasovna struktura elektronskih stanj v kristalih	117
9.4 Drudejev model elektronov v kovini	121
9.5 Model Fermijevega plina	122
9.6 Čisti in dopirani polprevodniki	123
9.7 Stik p - n in polprevodniške naprave	128
9.8 Superprevodnost	133



Kazalo vsebine

Jedrska fizika

10.1 Lastnosti jeder	138
10.2 Fizikalni modeli jedra	144
10.3 Jedrski magnetizem	149
10.4 Radioaktivnost in razpadni procesi	152
10.5 Jedrske reakcije	157
10.6 Razcep in zlivanje jeder	159
10.7 Posledice, meritve in uporaba radioaktivnega sevanja	163

Osnovni delci

11.1 Fundamentalne sile v naravi	167
11.2 Klasifikacija delcev	169
11.3 Kvarkovska sestava hadronov	172
11.4 Standardni model	176
11.5 Ohranitveni zakoni in Feynmanovi diagrami	178
11.6 Produkcija osnovnih delcev	180
11.7 Onstran standardnega modela	181

Literatura

182



Kazalo interaktivnih in video vsebin

1. Relativna simultanost	19	20. Periodni sistem elementov	85
2. Paradoks dvojčkov	21	21. Sestava atomov	85
3. Skrajšanje dolžine	22	22. Molekula H_2^+	94
4. „Zmanjšana“ hitrost svetlobe	27	23. Bozoni in fermioni	100
5. Sevanje črnega telesa	36	24. Bose-Einsteinova kondenzacija	106
6. Fotoefekt	39	25. Lasersko hlajenje	108
7. Rutherfordovo sipanje	44	26. Delovanje laserja	110
8. Valovni paket	50	27. Pasovna struktura	120
9. Kvantnomehanska interferenca	53	28. Stik p - n	129
10. Schrödingerjeva enačba	54	29. Ohmov zakon v superprevodniku	133
11. Neskončna potencialna jama	56	30. Meissnerjev efekt – levitacija	134
12. Kvantni harmonski oscilator	59	31. NMR in MRI	151
13. Razvoj po lastnih valovnih funkcijah	61	32. Jedrski razpad	152
14. Časovni razvoj valovnih funkcij	61	33. Razpad α	153
15. Kolaps valovne funkcije	61	34. Razpad β	154
16. Potencialna stopnica	62	35. Razcep jedra in jedrski reaktor	160
17. Potencialna plast	63	36. Fuzijski reaktor ITER	162
18. Atom vodika	74	37. Datiranje z radioaktivnostjo	165
19. Stern-Gerlachov poskus	77	38. Standardni model in Higgsov bozon	177





MODERNA FIZIKA

Relativnost 1 Transformacija prostora-časa

1.1 Uvod v moderno fiziko

- Sevanje črnega telesa:
kvantizacija energijskih nivojev

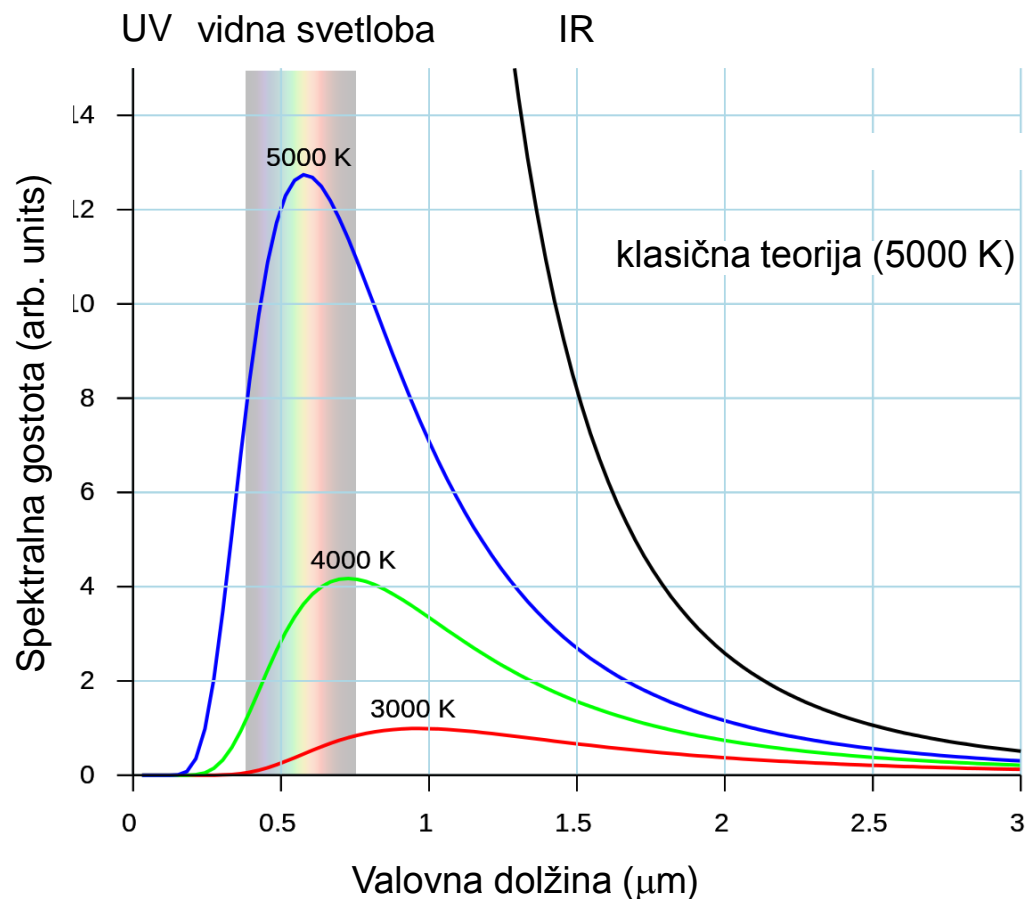

Vir: internet

The Nobel Prize in Physics 1918



Max Karl Ernst
Ludwig Planck
Prize share: 1/1

The Nobel Prize in Physics 1918 was awarded to Max Planck *"in recognition of the services he rendered to the advancement of Physics by his discovery of energy quanta"*.

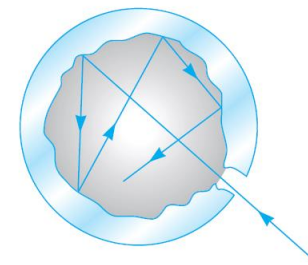

1.1 Uvod v moderno fiziko

- Fotoefekt: svetloba kot delci (fotoni)

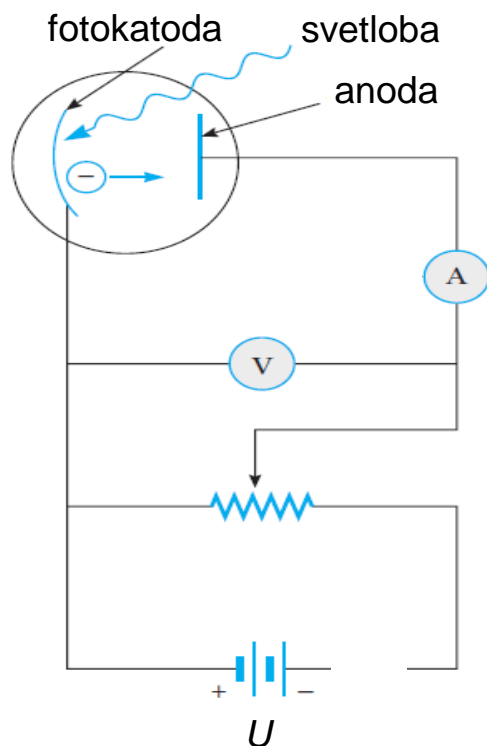

The Nobel Prize in Physics 1921

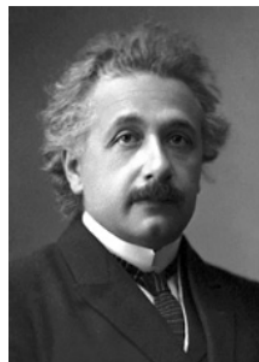

Albert Einstein
Prize share: 1/1

The Nobel Prize in Physics 1921 was awarded to Albert Einstein *"for his services to Theoretical Physics, and especially for his discovery of the law of the photoelectric effect"*.

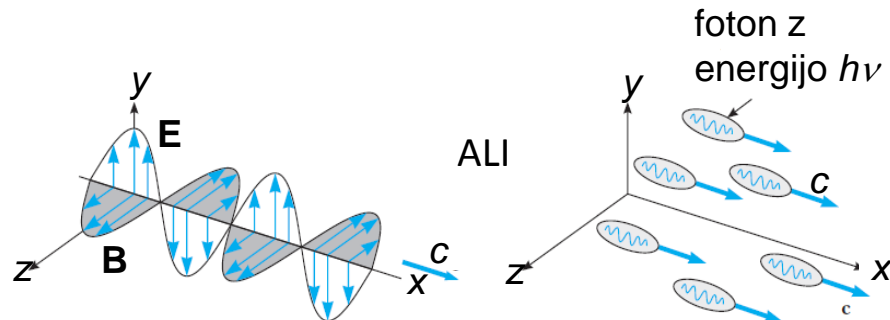

Vir: internet; povzeto po Serway, Moses & Moyer, Modern Physics, Thomson Learning, 2005

1.1 Uvod v moderno fiziko

➤ Michelson-Morleyev interferometer:

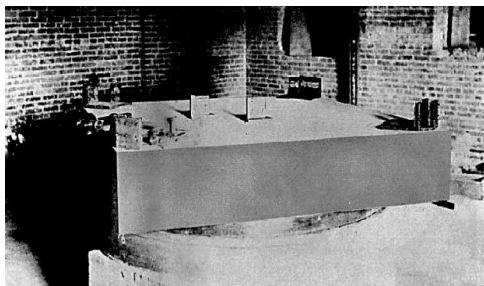
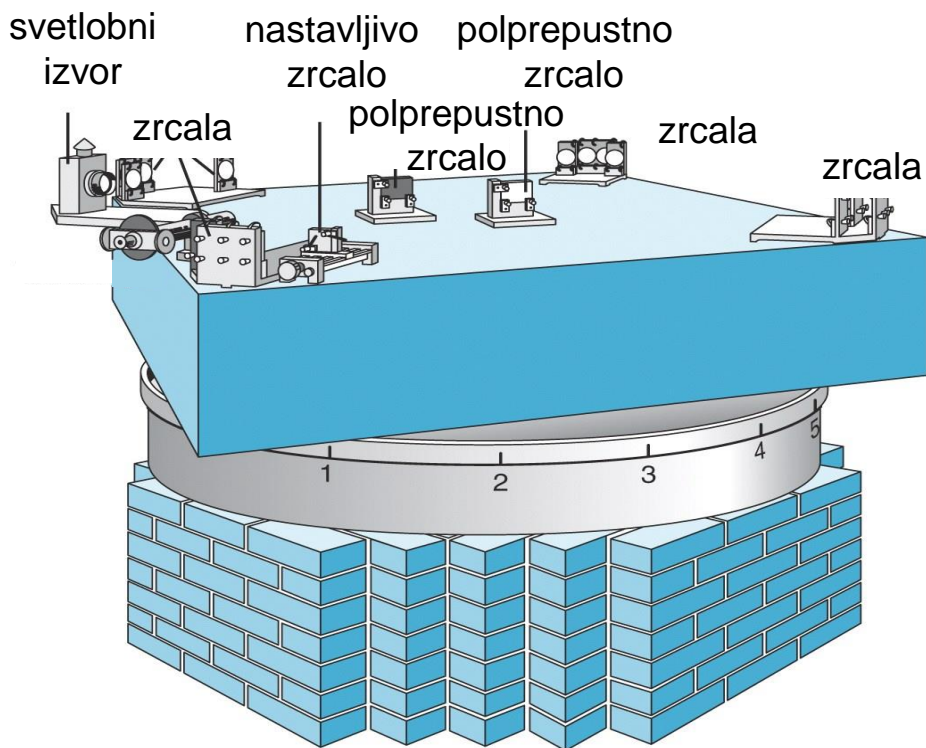

Vir: internet; povzeto po Tipler & Llevellyn, Modern Physics, W. H. Freeman and Company, 2012

The Nobel Prize in Physics 1907



Albert Abraham Michelson
Prize share: 1/1

The Nobel Prize in Physics 2017



Photo: Bryce Vickmark
Rainer Weiss
Prize share: 1/2

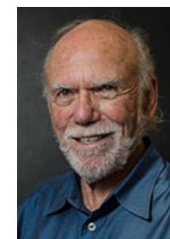

Photo: Caltech
Barry C. Barish
Prize share: 1/4



Photo: Caltech Alumni Association
Kip S. Thorne
Prize share: 1/4

The Nobel Prize in Physics 2017 was divided, one half awarded to Rainer Weiss, the other half jointly to Barry C. Barish and Kip S. Thorne "for decisive contributions to the LIGO detector and the observation of gravitational waves".

The Nobel Prize in Physics 1907 was awarded to Albert A. Michelson "for his optical precision instruments and the spectroscopic and metrological investigations carried out with their aid".

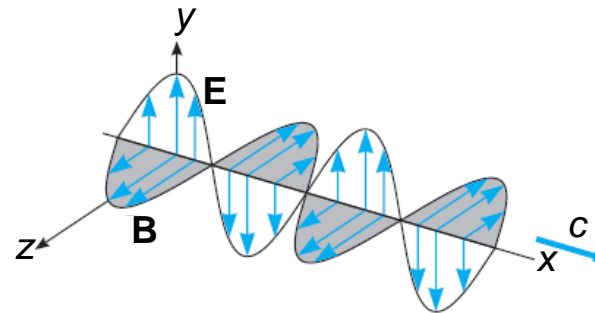

1.1 Uvod v moderno fiziko

Moderna fizika:

- teorija relativnosti
- kvantna mehanika

Arhitekti moderne fizike zbrani na „the Fifth International Congress of Physics“ (Bruselj, 1927):

- 15 Nobelovih nagrajencev iz fizike
- 3 Nobelovi nagrajenci iz kemije

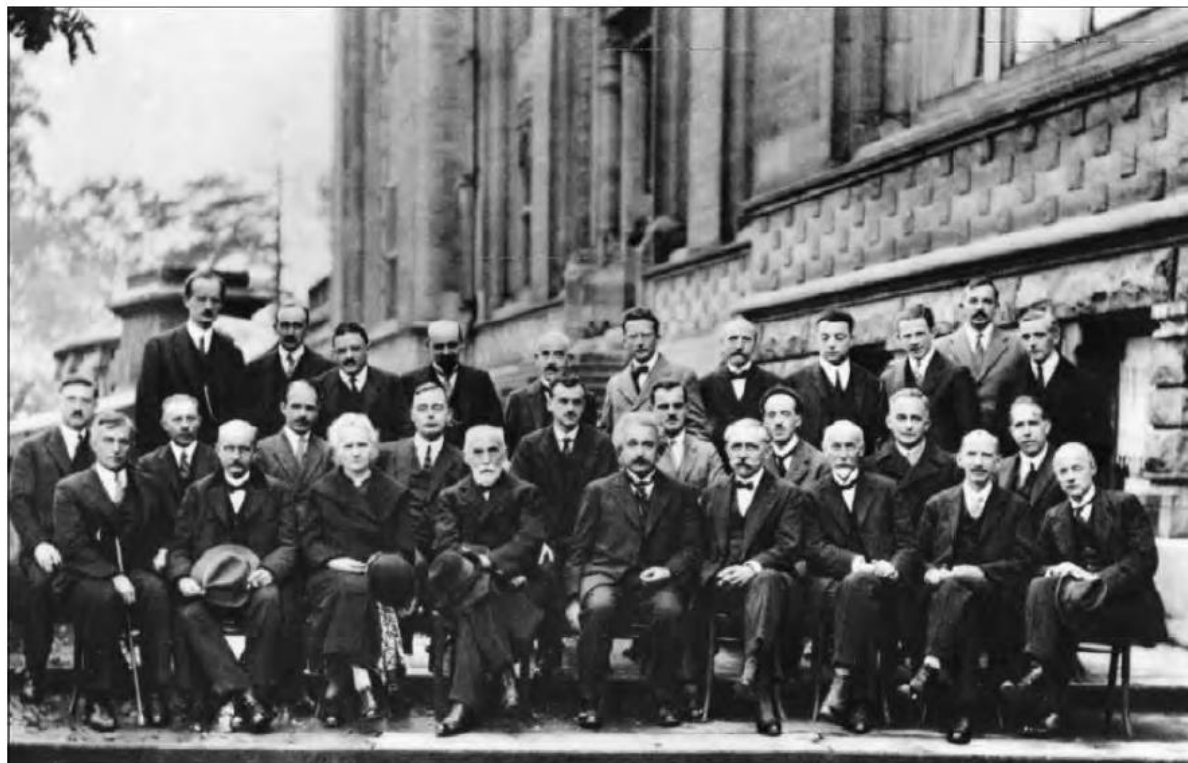

- | | | |
|--------------------|---------------------|---------------------|
| 1. A. Piccard | 11. L. Brillouin | 21. I. Langmuir |
| 2. E. Henriot | 12. P. Debye | 22. M. Planck |
| 3. P. Ehrenfest | 13. M. Knudsen | 23. M. Curie |
| 4. E. Herzen | 14. W.L. Bragg | 24. H.A. Lorentz |
| 5. Th. de Donder | 15. H.A. Kramers | 25. A. Einstein |
| 6. E. Schroedinger | 16. P.A.M. Dirac | 26. P. Langevin |
| 7. E. Verschaffelt | 17. A.H. Compton | 27. C.E. Guye |
| 8. W. Pauli | 18. L.V. de Broglie | 28. C.T.R. Wilson |
| 9. W. Heisenberg | 19. M. Born | 29. O.W. Richardson |
| 10. R.H. Fowler | 20. N. Bohr | |

Vir: povzeto po Serway, Moses & Moyer, Modern Physics, Thomson Learning, 2005

1.2 Klasična relativnost

- Invariantnost zakonov mehanike v inercialnih sistemih:

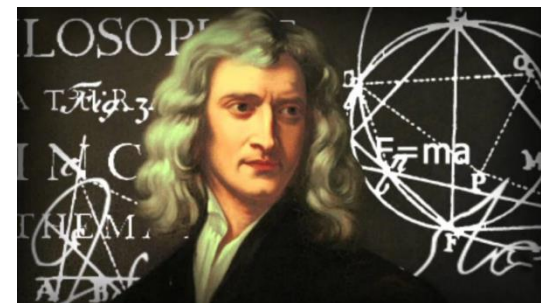

Isaac Newton

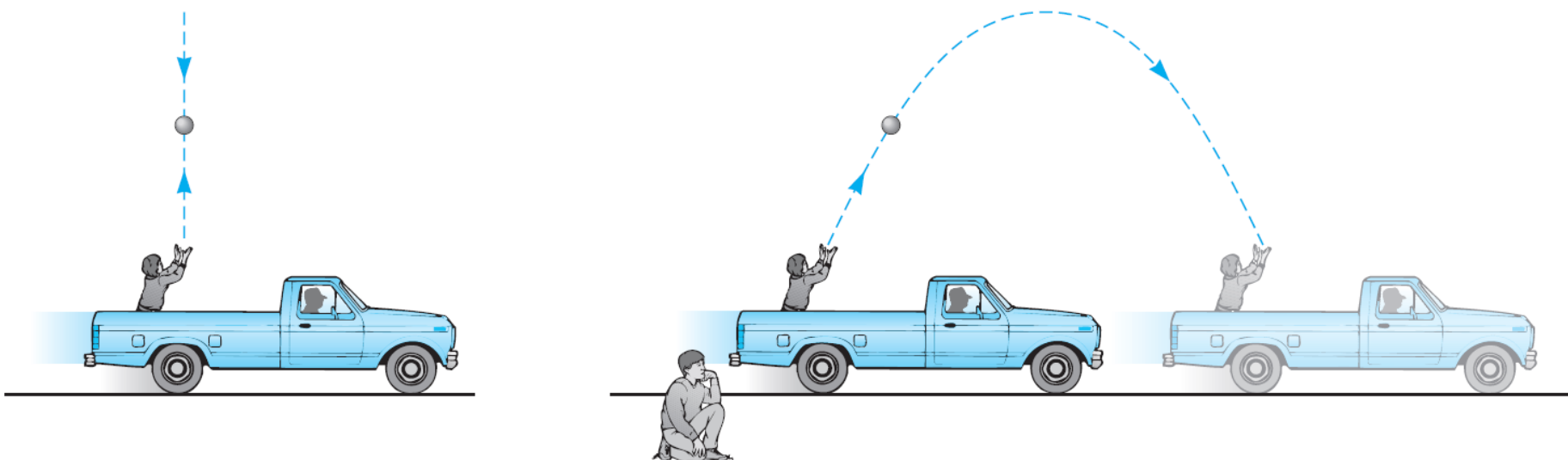

Vir: internet; povzeto po Serway, Moses & Moyer, Modern Physics, Thomson Learning, 2005

1.2 Klasična relativnost

- Relativno gibanje: opazovalec meri le relativno gibanje!

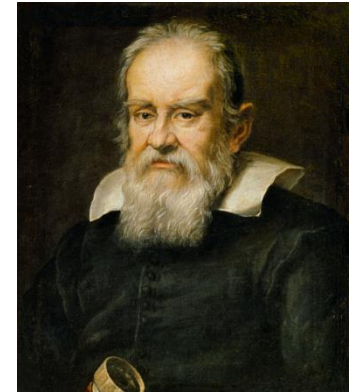
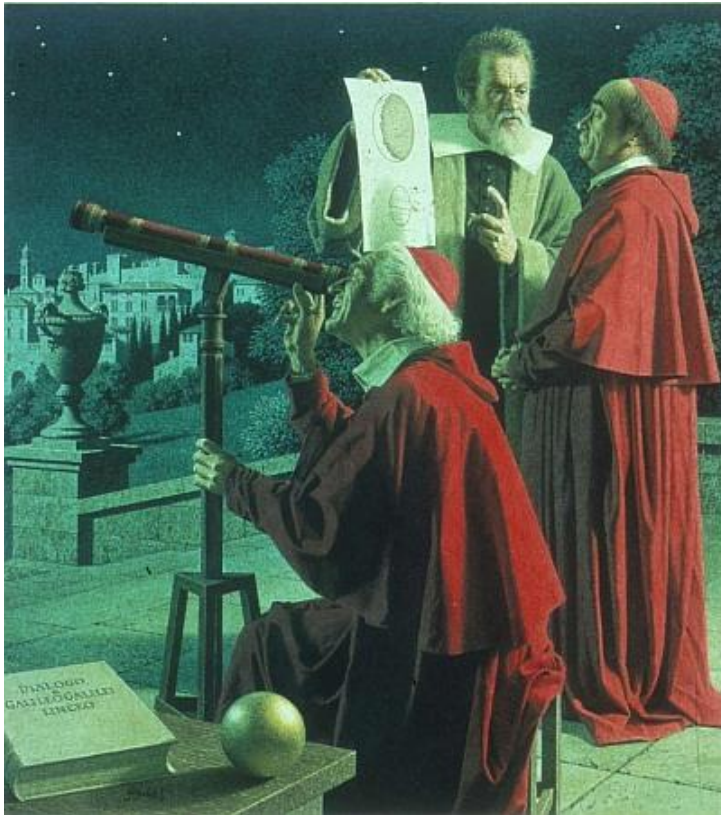

Galileo Galilei



Vir: internet

1.2 Klasična relativnost

➤ Princip relativnosti: opazovalec ne razlikuje med mirovanjem in enakomernim gibanjem!

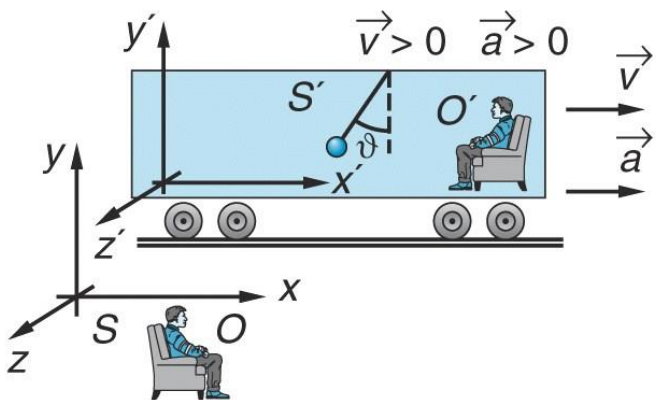
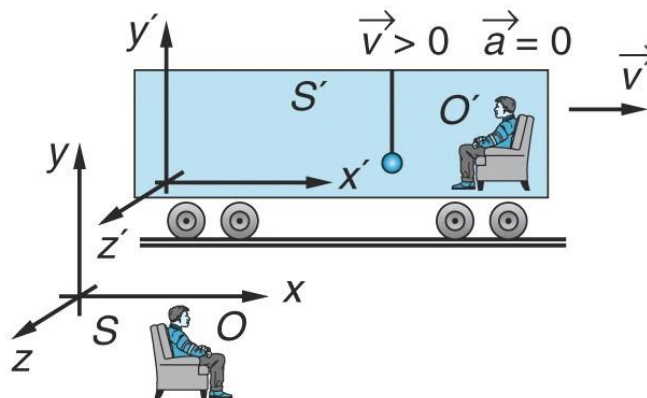
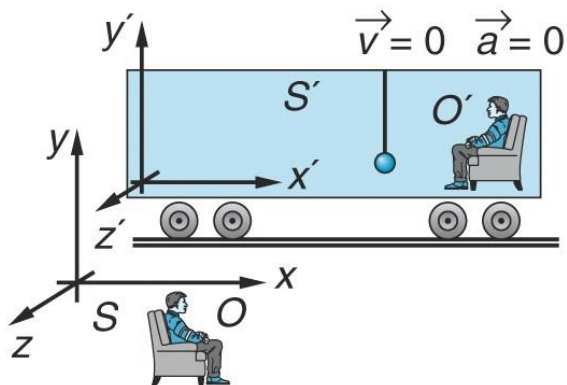

➤ Galilejeve transformacije:
homogenost prostora,
absolutnost časa

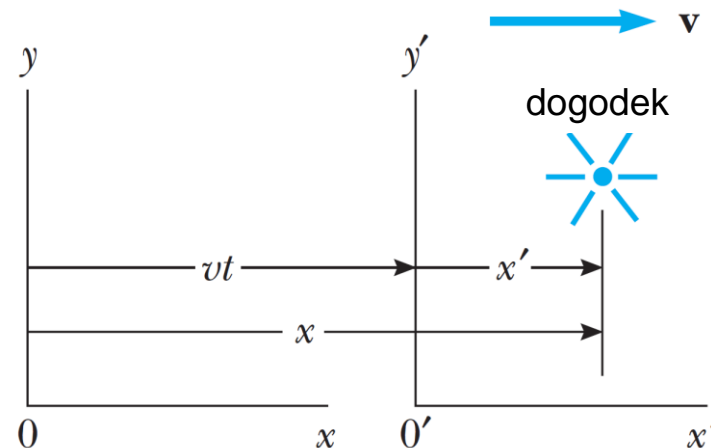

Vir: povzeto po Tipler & Llewellyn, Modern Physics, W. H. Freeman and Company, 2012

1.3 Michelson-Morleyev eksperiment

➤ Hitrost svetlobe: Galileijeva transformacija

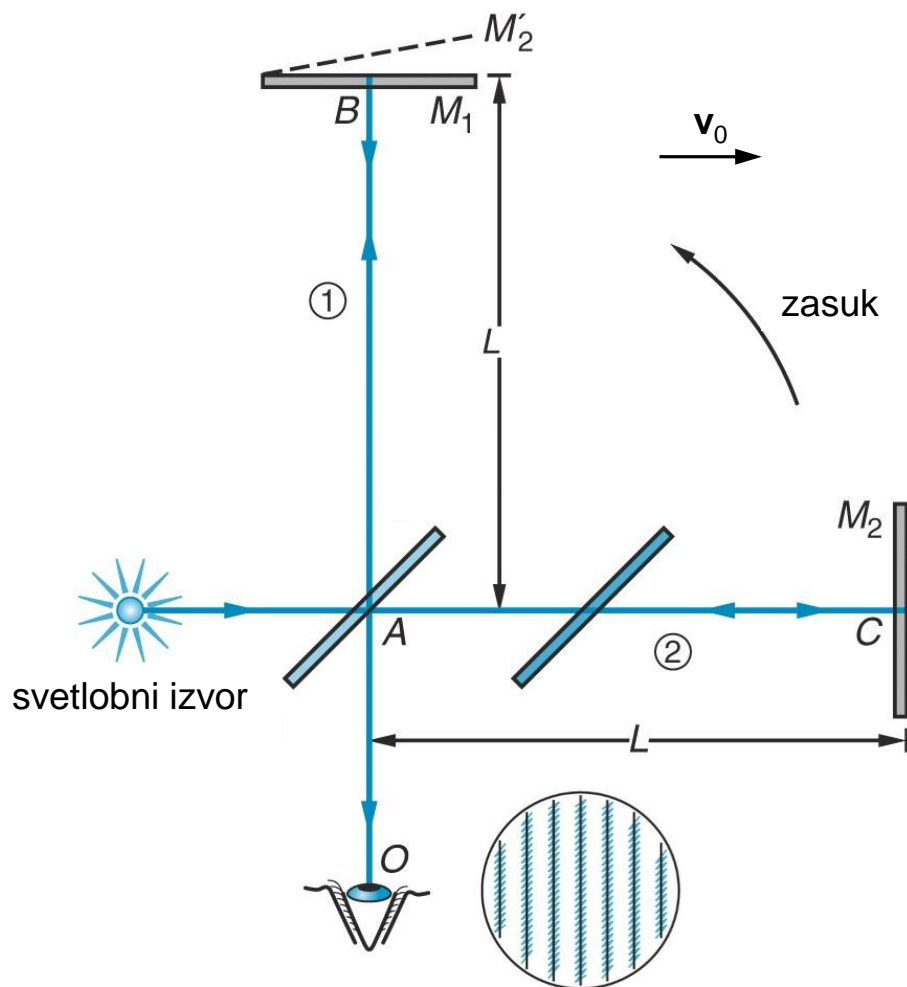

$$t_1 = \frac{2L}{c\sqrt{1 - v_0^2/c^2}} = 2L\gamma = \frac{2L}{c} \left(1 + \frac{1}{2} \frac{v_0^2}{c^2} \right)$$

$$t_2 = \frac{L}{c + v_0} + \frac{L}{c - v_0} = \frac{2L}{c(1 - v_0^2/c^2)}$$

$$= \frac{2L}{c} \gamma^2 = \frac{2L}{c} \left(1 + \frac{v_0^2}{c^2} \right)$$

$$\gamma = \frac{1}{\sqrt{1 - v_0^2/c^2}}$$

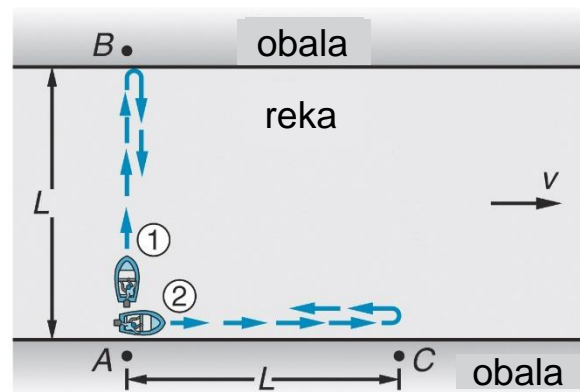

Vir: povzeto po Tipler & Llewellyn, Modern Physics, W. H. Freeman and Company, 2012

1.4 Posebna teorija relativnosti

➤ G. F. Fitzgerald in H. A. Lorentz:
kontrakcija dolžine (ad hoc predpostavka, l. 1890)

$$L' = \frac{L}{\gamma}$$

$$t_2 = \frac{2L'}{c} \gamma^2 = \frac{2L}{c} \gamma = t_1$$

$$\gamma = \frac{1}{\sqrt{1 - v_0^2/c^2}}$$

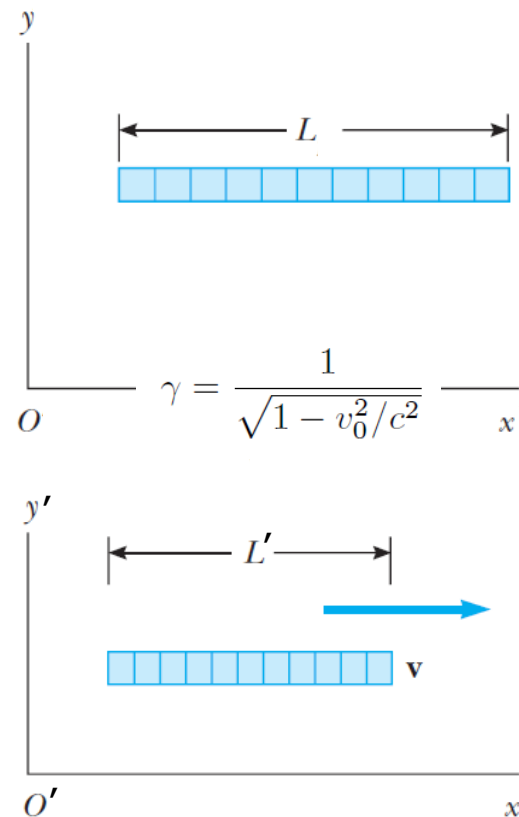

Vir: povzeto po Serway, Moses & Moyer, Modern Physics, Thomson Learning, 2005

1.4 Posebna teorija relativnosti

- Einsteinov miselni eksperiment: lovljenje svetlobe

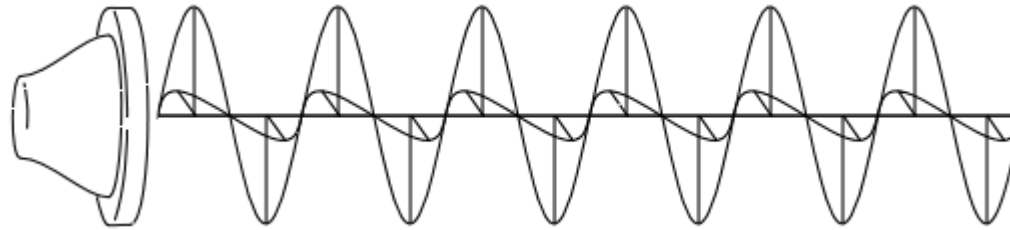

mirujoč opazovalec

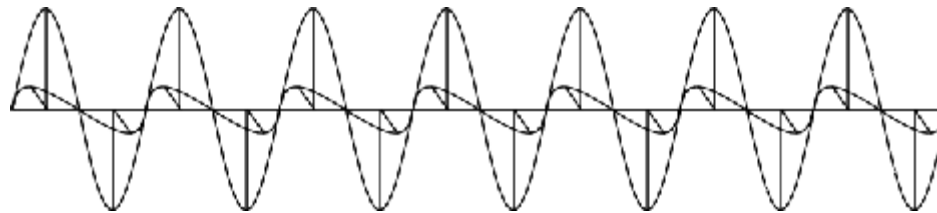

„surfer“

1.4 Posebna teorija relativnosti



Article

Zur Elektrodynamik bewegter Körper

A. Einstein

$$\tau = \beta \left(t - \frac{v}{V^2} x \right),$$

$$\xi = \beta (x - v t),$$

$$\eta = y,$$

$$\zeta = z,$$

$$\beta = \frac{1}{\sqrt{1 - \left(\frac{v}{V}\right)^2}},$$

➤ Einsteinova postulata:

1. Princip relativnosti: zakoni fizike so enaki v vseh inercialnih sistemih!
2. Konstantnost hitrosti svetlobe: hitrost svetlobe je v vseh inercialnih sistemih enaka c !

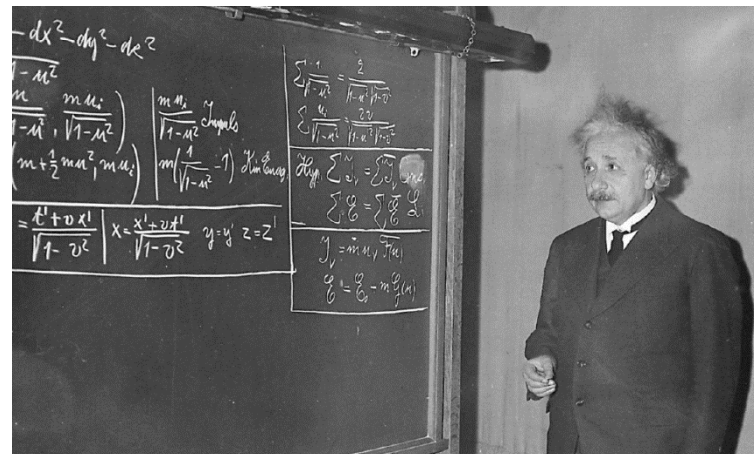

Albert Einstein

Vir: A. Einstein, Ann. Physik **322**, 891 (1905); internet

1.4 Posebna teorija relativnosti

➤ Koncepti relativnosti:

1. dogodek: vektor četverec $x^\mu = (ct, x, y, z)$
2. opazovalec
3. prostor umerjen, ure sinhronizirane znotraj določenega sistema
4. diagram Minkowskega (svetovnica)

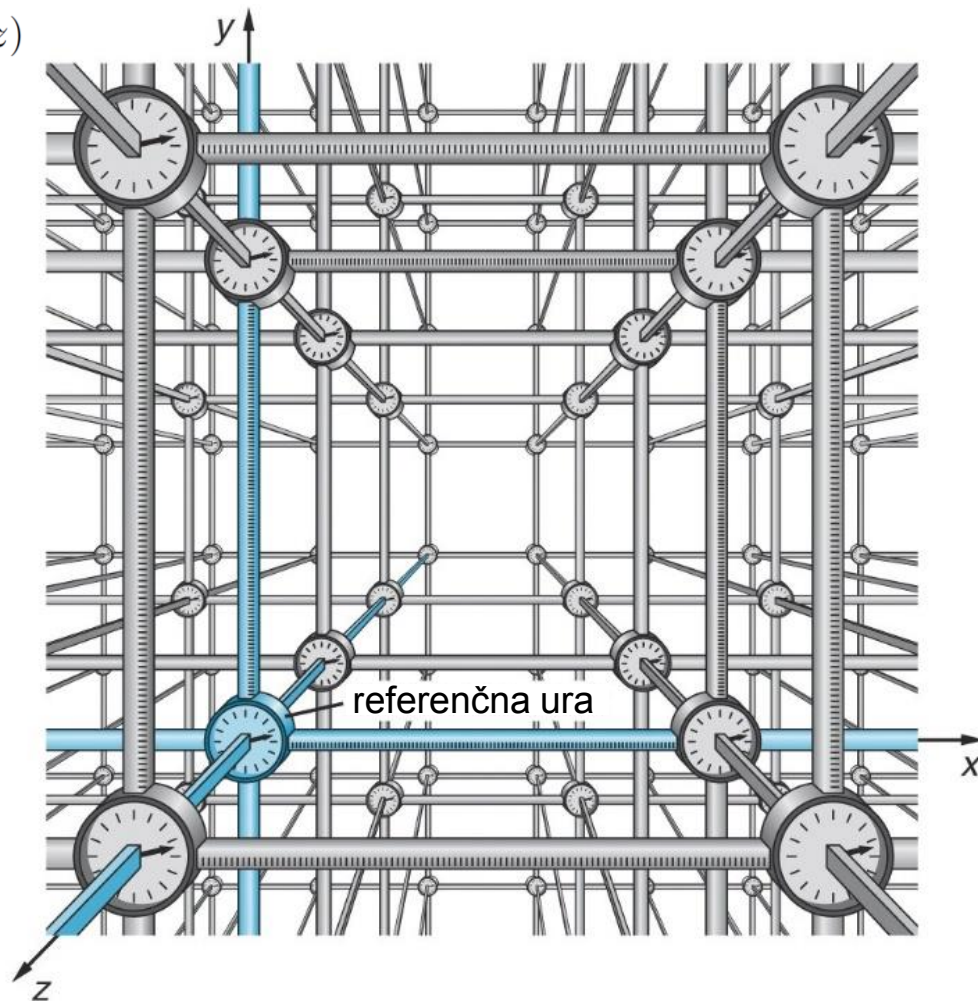
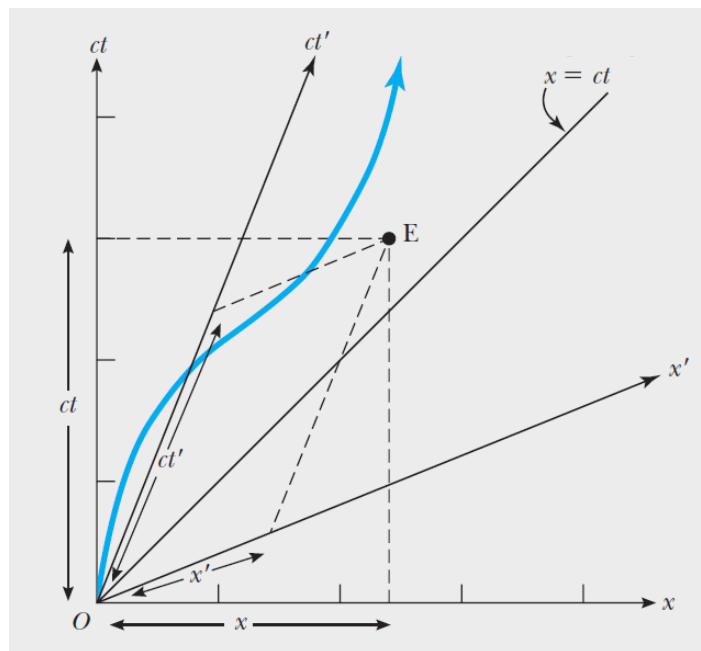

Vir: povzeto po Tipler & Llewellyn, Modern Physics, W. H. Freeman and Company, 2012

1.5 Posledice posebne teorije relativnosti

➤ Relativnost simultanosti: simultanost NI absoluten koncept!

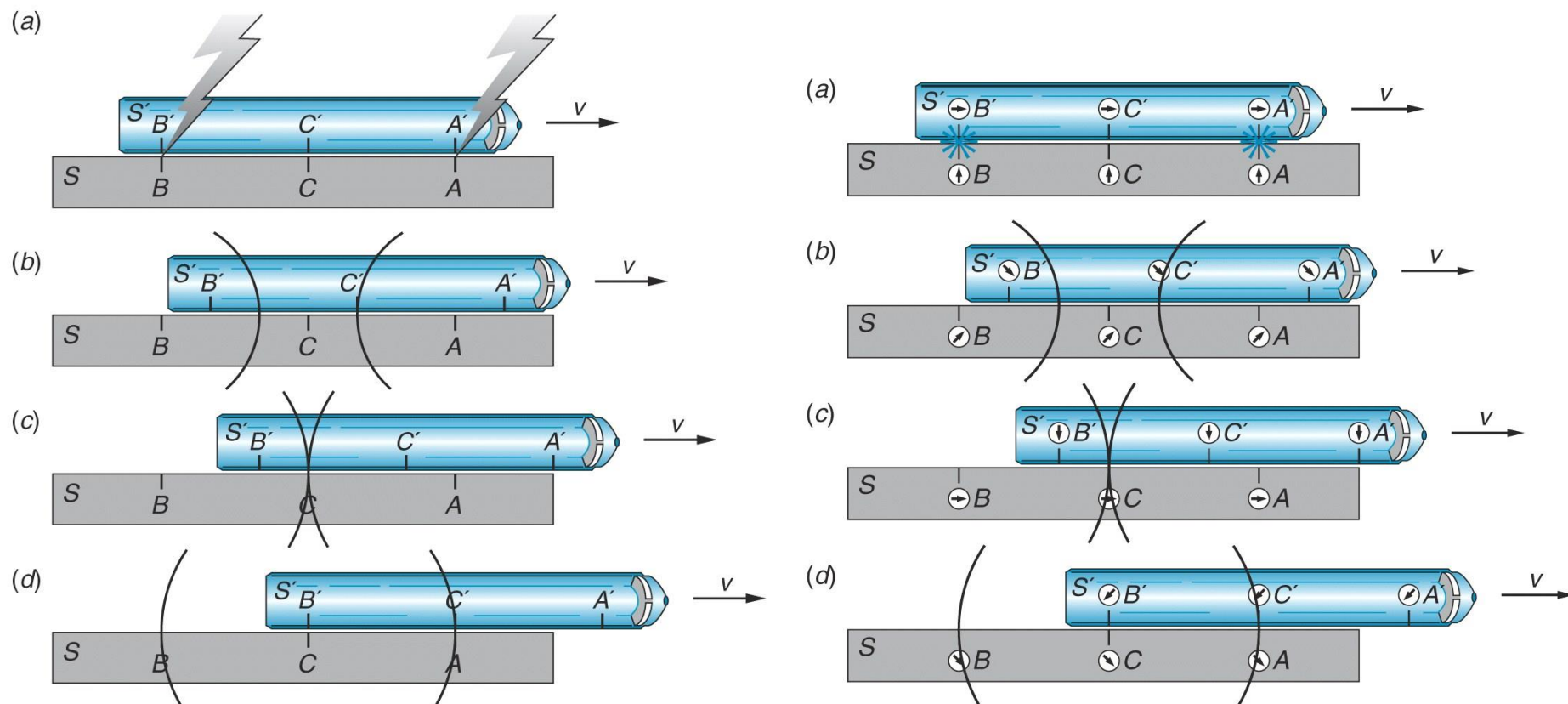

SIMULACIJA

Vir: povzeto po Tipler & Llewellyn, Modern Physics, W. H. Freeman and Company, 2012

1.5 Posledice posebne teorije relativnosti

- Podaljšanje (dilatacija) časa: lastni čas med dogodkoma na istem mestu je najkrajši!

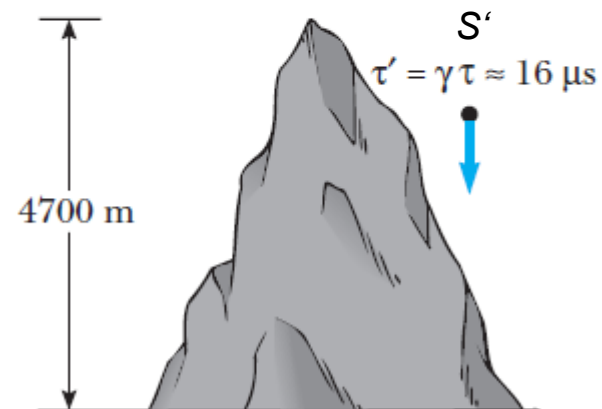
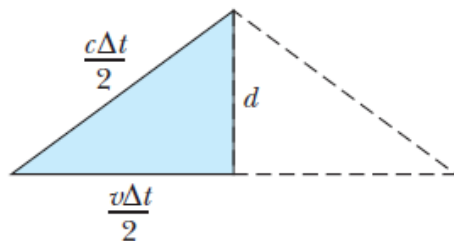
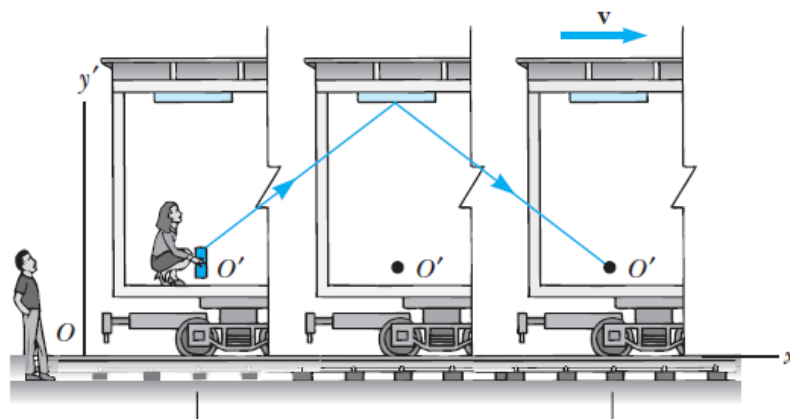
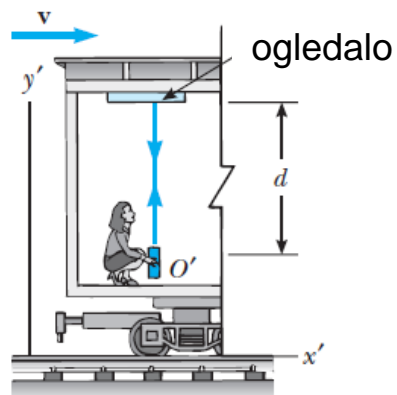

Vir: povzeto po Serway, Moses & Moyer, Modern Physics, Thomson Learning, 2005

1.5 Posledice posebne teorije relativnosti

- Podaljšanje (dilatacija) časa: lastni čas med dogodkoma na istem mestu je najkrajši!

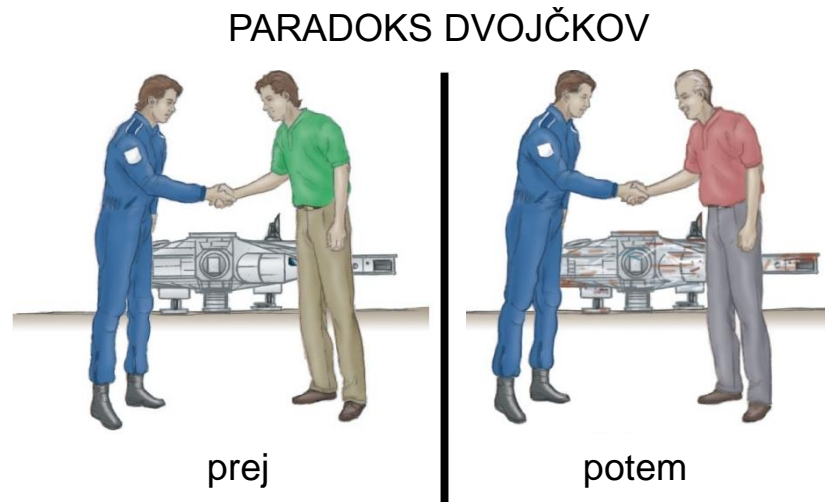

SIMULACIJA

Vir: internet

1.5 Posledice posebne teorije relativnosti

- Skrajšanje (kontrakcija) dolžine: lastna dolžina predmeta, ki miruje, je najdaljša!

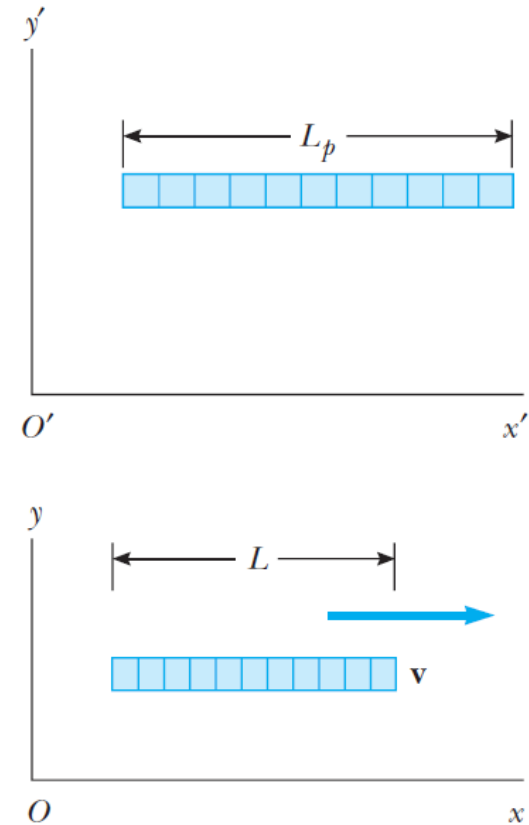
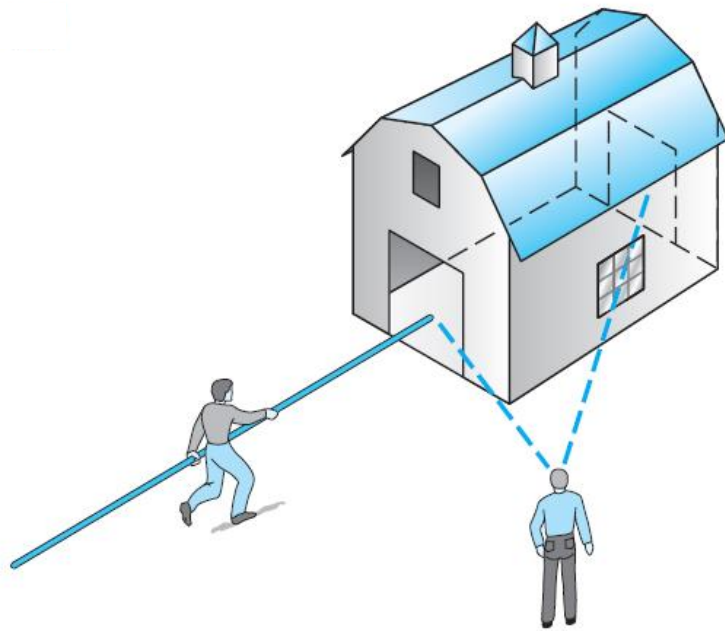

SIMULACIJA

Vir: povzeto po Serway, Moses & Moyer, Modern Physics, Thomson Learning, 2005; Tipler & Llewellyn, Modern Physics, W. H. Freeman and Company, 2012

1.6 Lorentzova transformacija

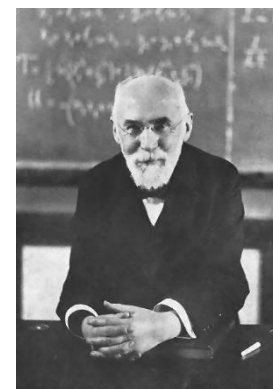
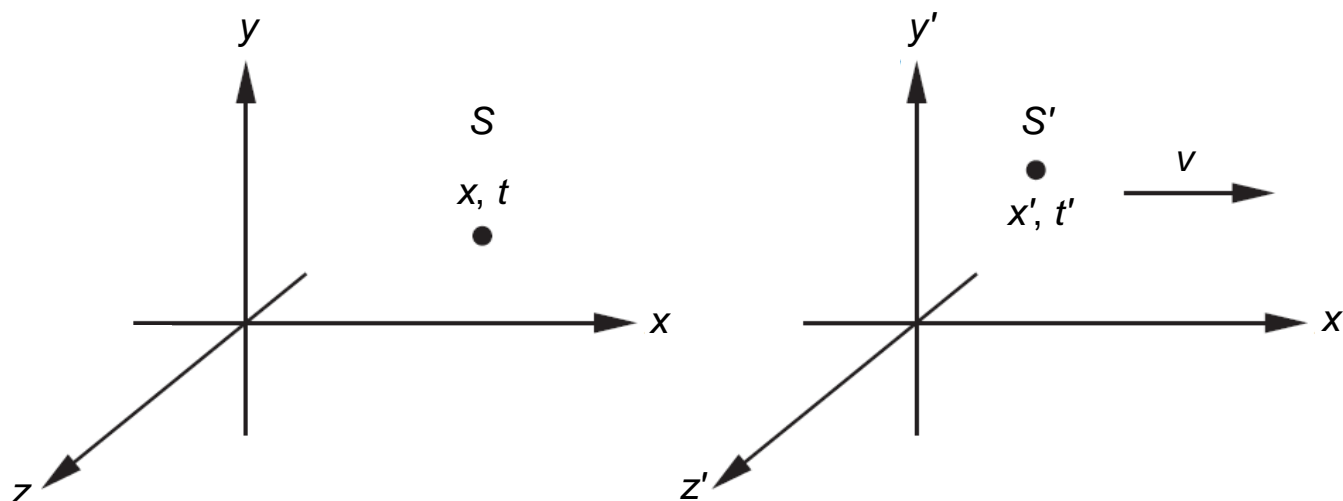

Henrik Lorentz

$$x = \gamma_0 (x' + \beta ct')$$

$$x' = \gamma_0 (x - \beta ct)$$

$$y = y'$$

$$y' = y$$

$$z = z'$$

$$z' = z$$

$$ct = \gamma_0 (ct' + \beta x')$$

$$ct' = \gamma_0 (ct - \beta x)$$

$$\gamma_0 = \frac{1}{\sqrt{1 - v_0^2/c^2}}$$

$$\beta = \frac{v_0}{c}$$

➤ Skalarni produkt: invariants

$$x^\mu x^\mu = s^2 = (ct)^2 - (x^2 + y^2 + z^2)$$

Vir: internet



MODERNA FIZIKA

Relativnost 2 Kinematika

2.1 Transformacija hitrosti

$$v'_x = \frac{v_x - v_0}{1 - \frac{v_0 v_x}{c^2}}$$
$$v'_y = \frac{v_y}{\gamma_0 \left(1 - \frac{v_0 v_x}{c^2}\right)}$$
$$v'_z = \frac{v_z}{\gamma_0 \left(1 - \frac{v_0 v_x}{c^2}\right)}$$

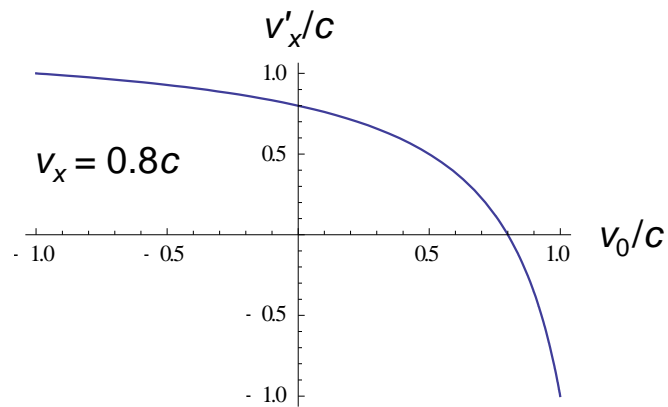
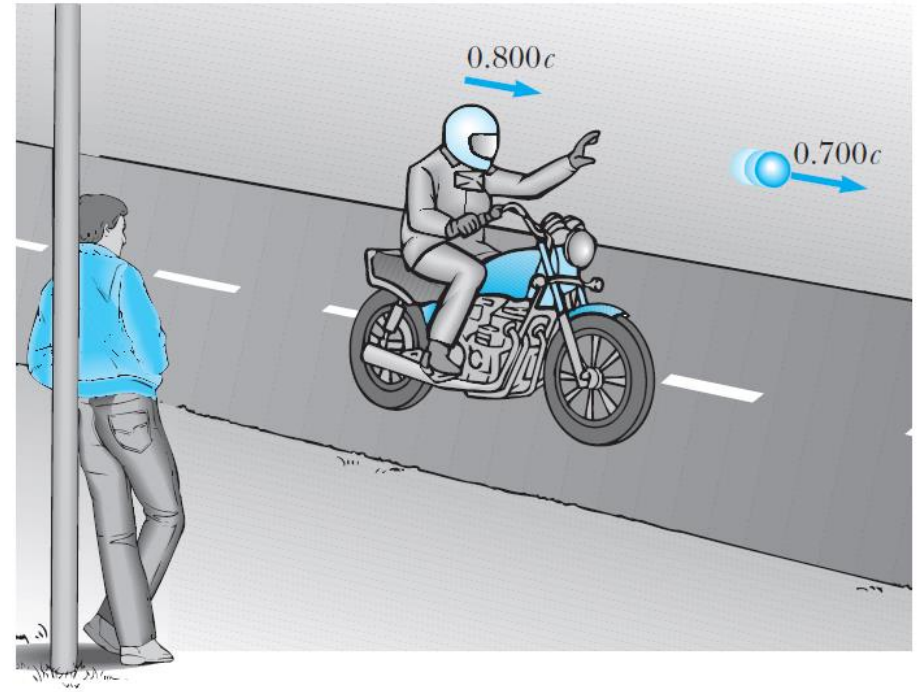

Vir: povzeto po Serway, Moses & Moyer, Modern Physics, Thomson Learning, 2005

2.2 Relativistični Dopplerjev premik



“I love hearing that lonesome wail of the train whistle as the frequency of the wave changes due to the Doppler effect.”

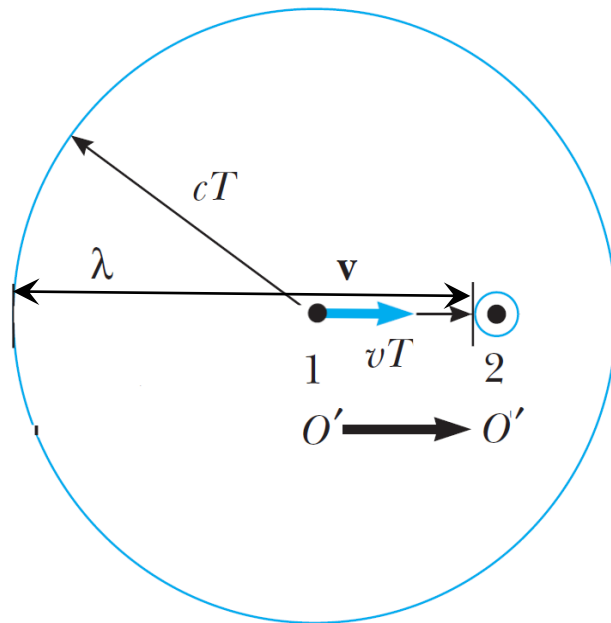
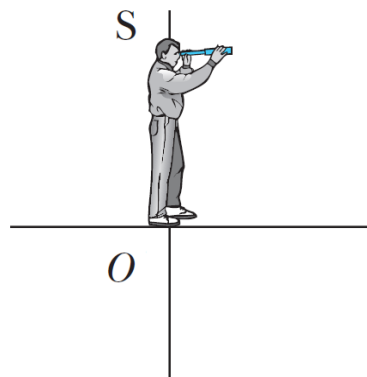

Rdeči premik:

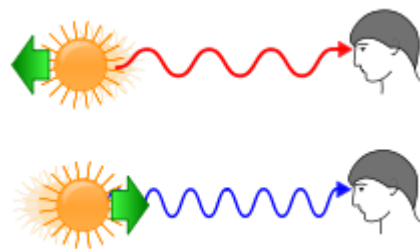

$$\omega' = \gamma_0 \omega \left(1 - \frac{v_0}{c} \cos \theta \right)$$

$$\sin \theta' = \frac{\sin \theta}{\gamma_0 \left(1 - \frac{v_0}{c} \cos \theta \right)}$$

➤ Valovni vektor četverec: $k^\mu = \left(\frac{\omega}{c}, k_x, k_y, k_z \right)$

Vir: internet, povzeto po Serway, Moses & Moyer, Modern Physics, Thomson Learning, 2005

2.2 Relativistični Dopplerjev premik

- Transverzalni relativistični Dopplerjev premik – smer relativnega gibanja pravokotna na smer širjenja svetlobe:

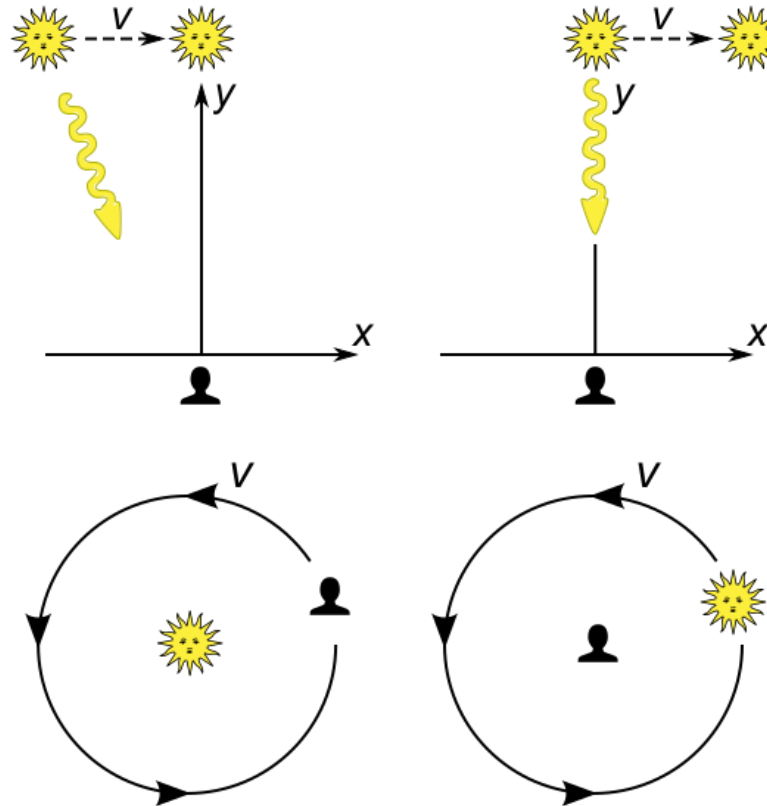

SIMULACIJA

Vir: internet

2.3 Relativistična gibalna količina

➤ „Klasična“ gibalna količina se ne ohranja:

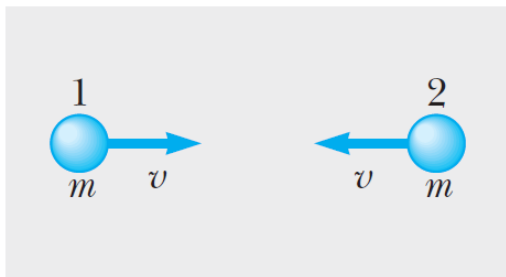

(a)

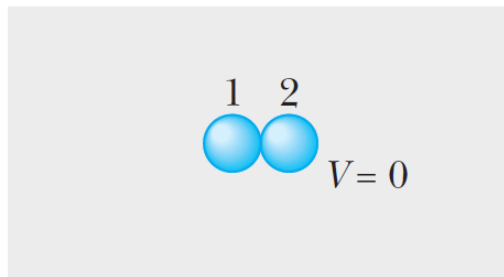

$$\begin{aligned} p_{\text{pred}} &= mv + m(-v) = 0 \\ p_{\text{po}} &= 0 \end{aligned}$$

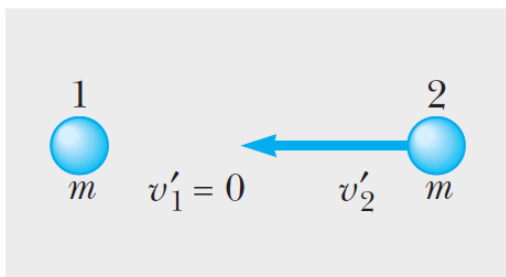

(b)

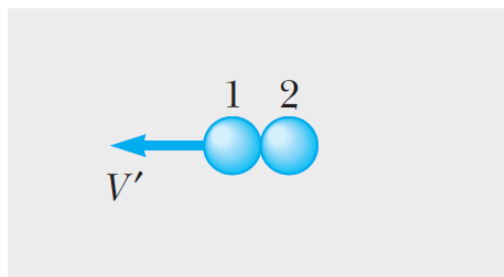

$$\begin{aligned} p'_{\text{pred}} &= \frac{-2mv}{1 + v^2/c^2} \\ p'_{\text{po}} &= -2mv \end{aligned}$$

➤ Relativistično:

$$\mathbf{p} = \gamma m \mathbf{v}$$

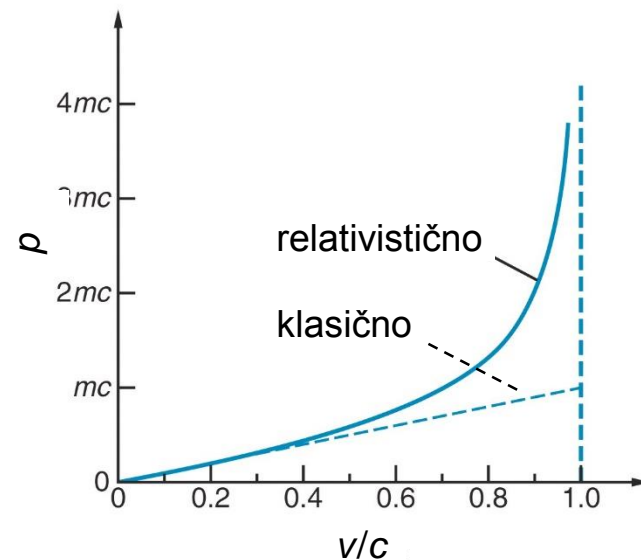

➤ Relativistična gibalna enačba:

$$F = \frac{dp}{dt} = \frac{d}{dt} (\gamma m v) = \frac{m}{(1 - v^2/c^2)^{3/2}} \frac{dv}{dt}$$

Vir: povzeto po Serway, Moses & Moyer, Modern Physics, Thomson Learning, 2005; Tipler & Llewellyn, Modern Physics, W. H. Freeman and Company, 2012

2.4 Relativistična energija

➤ „Klasična“ (kinetična) energija se ne ohranja!

$$T = (\gamma - 1)mc^2$$

$$W = T + mc^2 = \gamma mc^2$$

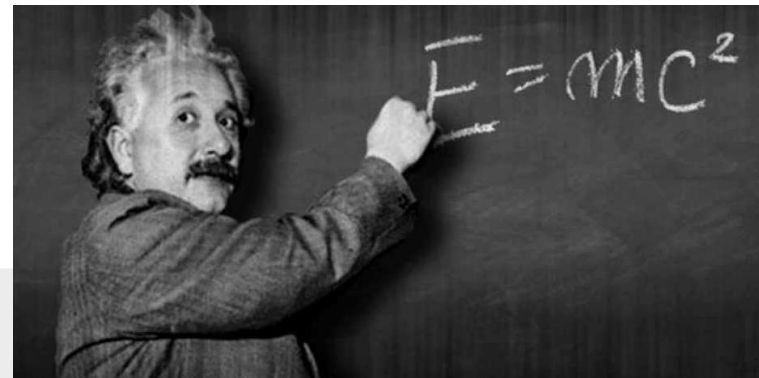

Albert Einstein

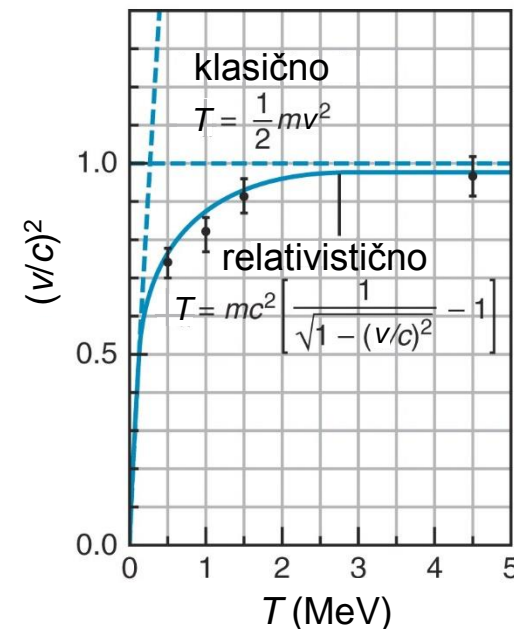
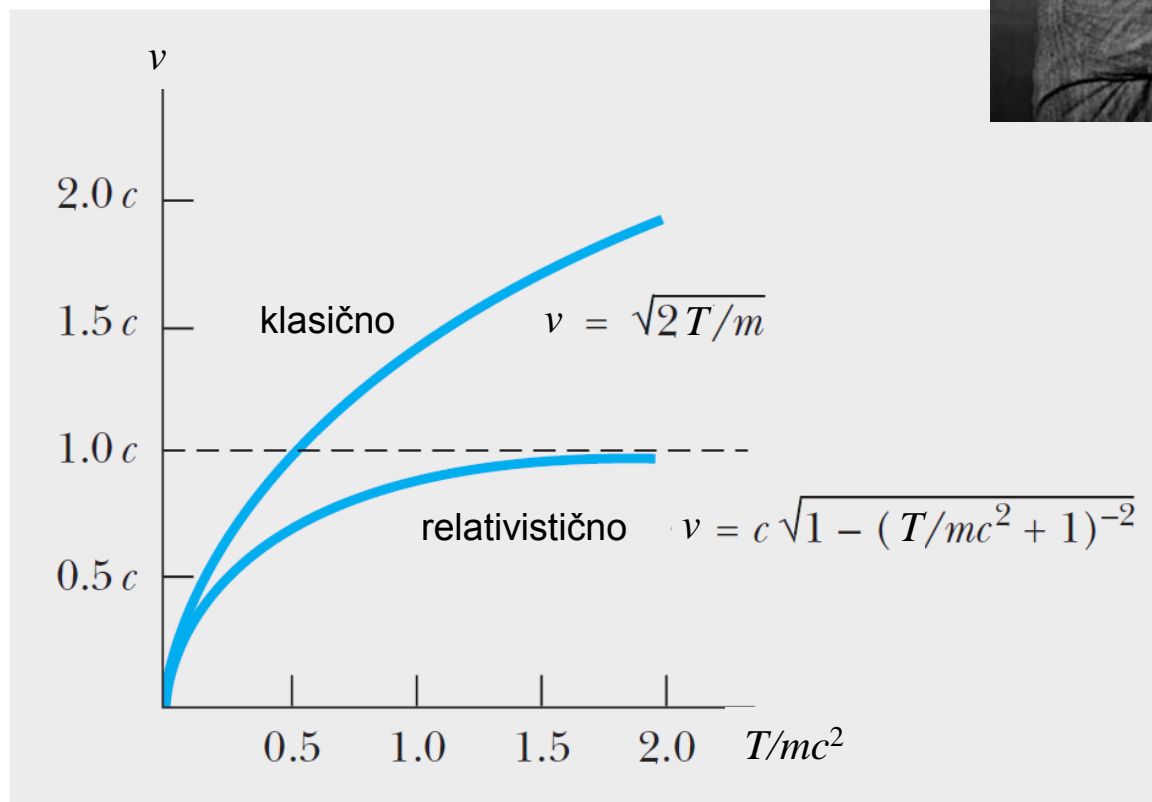

Vir: povzeto po Serway, Moses & Moyer, Modern Physics, Thomson Learning, 2005; Tipler & Llewellyn, Modern Physics, W. H. Freeman and Company, 2012

2.5 Vektorji četverci in invariante

➤ Krajevni vektor četverec

$$x^\mu = (ct, x, y, z)$$

$$x' = \gamma_0 (x - \beta ct)$$

$$y' = y$$

$$z' = z$$

$$ct' = \gamma_0 (ct - \beta x)$$

➤ Valovni vektor četverec

$$k^\mu = \left(\frac{\omega}{c}, k_x, k_y, k_z \right)$$

$$k'_x = \gamma_0 \left(k_x - \beta \frac{\omega}{c} \right)$$

$$k'_y = k_y$$

$$k'_z = k_z$$

$$\frac{\omega'}{c} = \gamma_0 \left(\frac{\omega}{c} - \beta k_x \right)$$

➤ Četverec gibalne količine

$$p^\mu = \left(\frac{W}{c}, p_x, p_y, p_z \right)$$

$$p'_x = \gamma_0 \left(p_x - \beta \frac{W}{c} \right)$$

$$p'_y = p_y$$

$$p'_z = p_z$$

$$\frac{W'}{c} = \gamma_0 \left(\frac{W}{c} - \beta p_x \right)$$

$$x^\mu x_\mu = s^2 = (ct)^2 - (x^2 + y^2 + z^2)$$

$$k^\mu k_\mu = \left(\frac{\omega}{c} \right)^2 - (k_x^2 + k_y^2 + k_z^2) = 0$$

$$p^\mu p_\mu = \left(\frac{W}{c} \right)^2 - (p_x^2 + p_y^2 + p_z^2) = m^2 c^2$$



2.6 Sistem delcev

➤ Razpad piona: $\pi^+ \rightarrow \mu^+ + \nu$

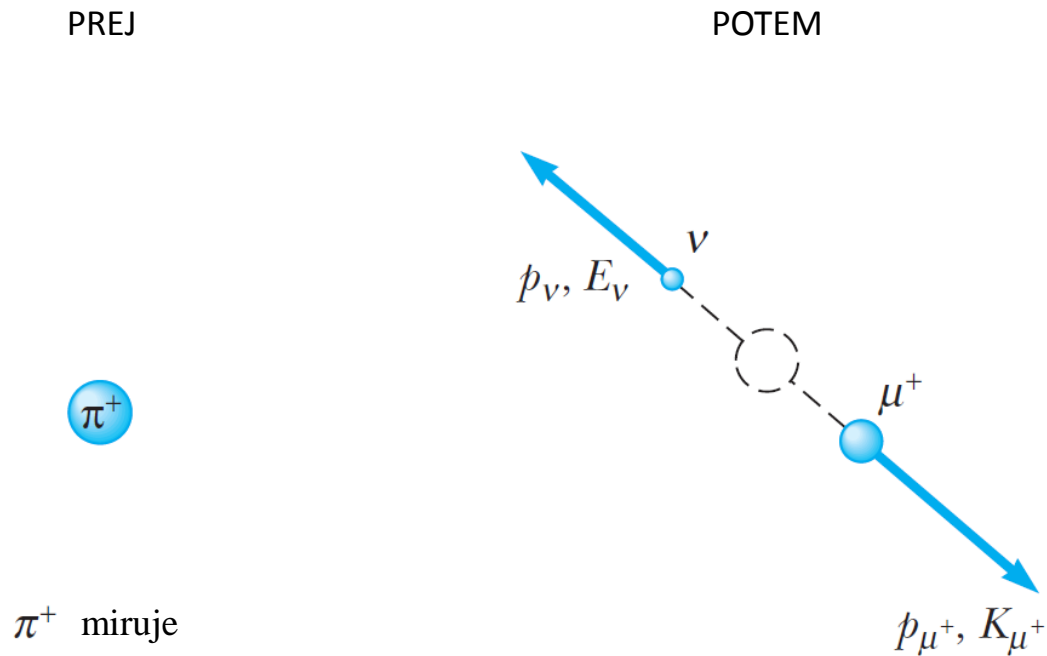

Vir: povzeto po Serway, Moses & Moyer, Modern Physics, Thomson Learning, 2005

2.6 Sistem delcev

POSPEŠEVALNIKI

vs.

TRKALNIKI

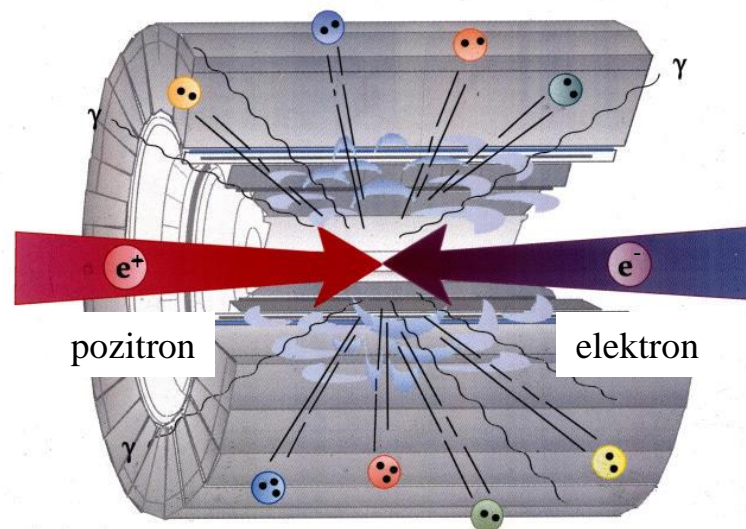
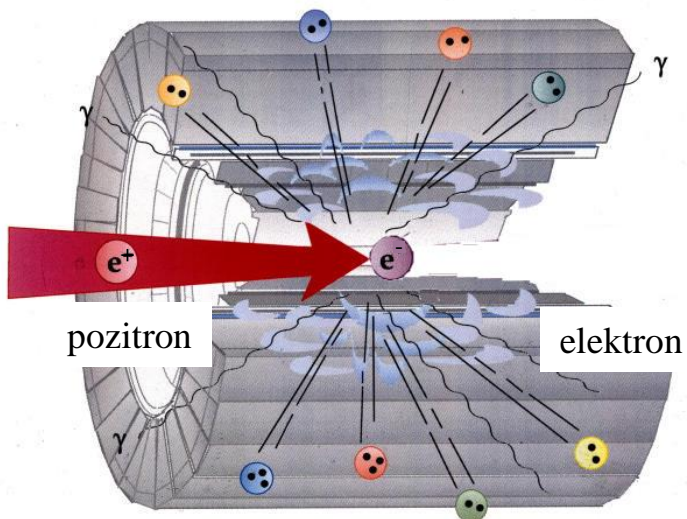

Vir: internet





MODERNA FIZIKA

Kvantna mehanika 1 Valovanje ali delci?

3.1 Uvod v kvantno mehaniko

➤ V čem je kvantna fizika nekonvencionalna?

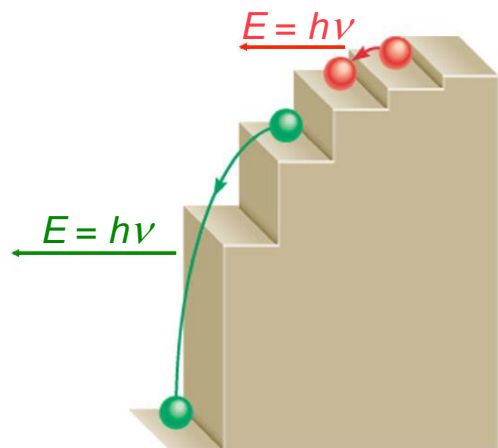

1. kvantizacija fizikalnih količin

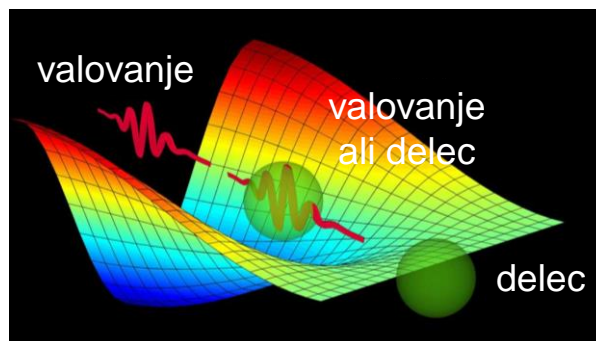

2. dualnost delec - valovanje

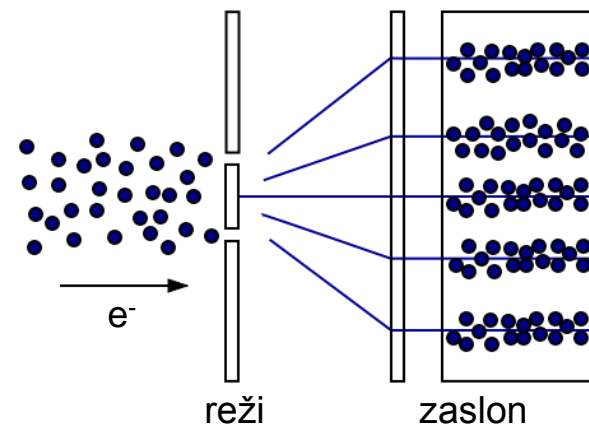

3. verjetnostne napovedi

➤ NAČELO KORESPONDENCE

Vir: internet

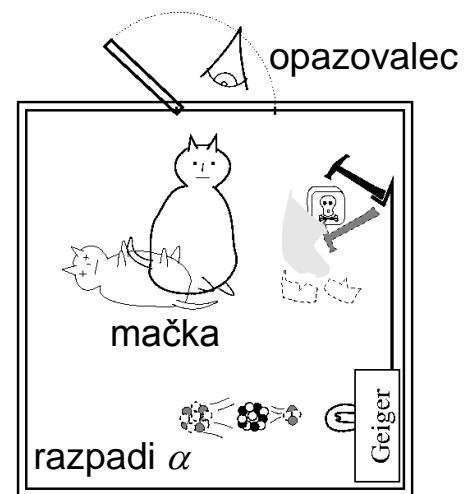

4. problem opazovalca

3.2 Svetloba – valovanje ali delci?

➤ Hertzov poskus (l. 1887): EM valovanje in nihajoč naboj



Heinrich Hertz

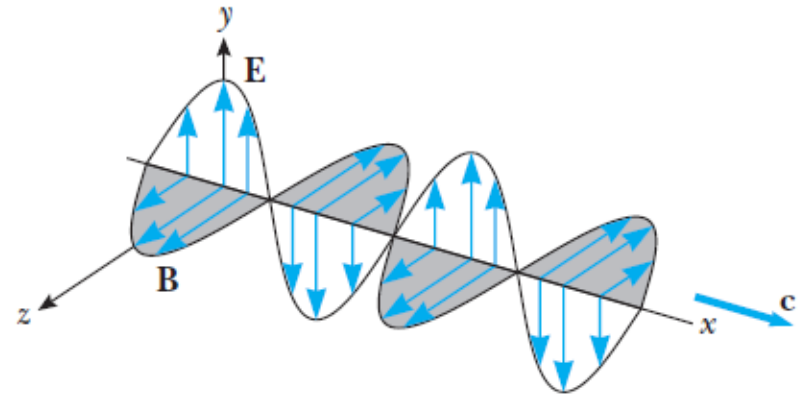
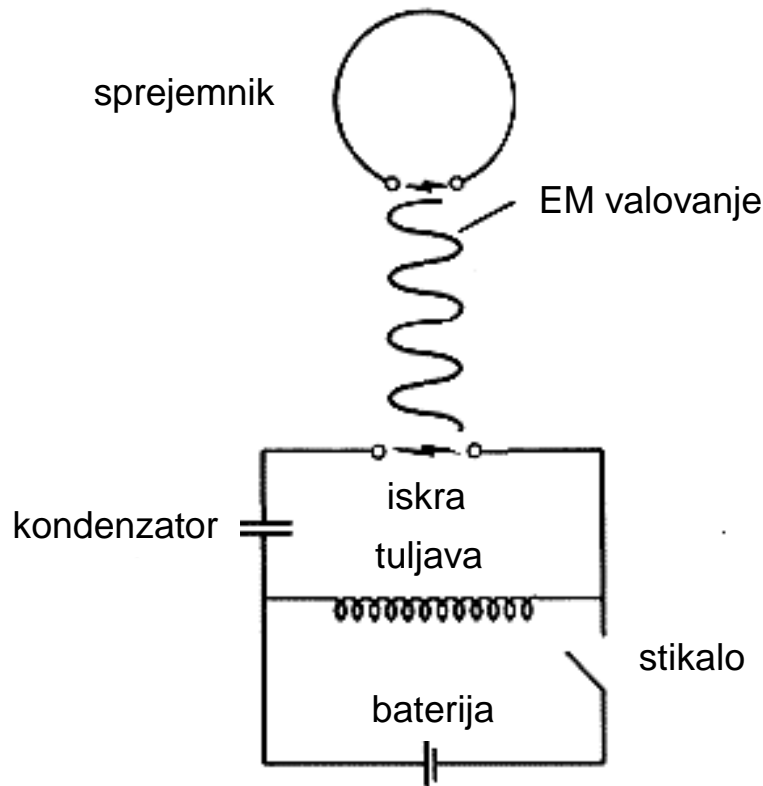

Vir: internet; povzeto po Serway, Moses & Moyer, Modern Physics, Thomson Learning, 2005

3.2 Svetloba – valovanje ali delci?

➤ Sevanje črnega telesa:

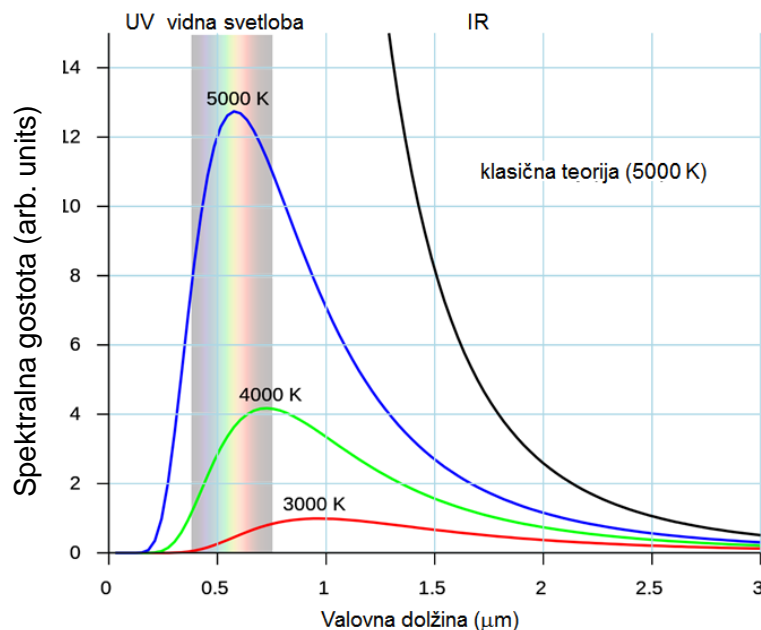

The Nobel Prize in Physics 1911



Wilhelm Wien
Prize share: 1/1

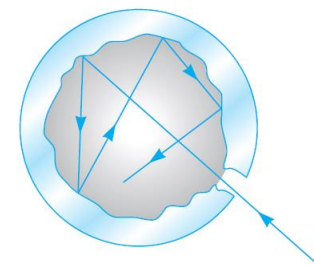

The Nobel Prize in Physics 1911 was awarded to Wilhelm Wien "for his discoveries regarding the laws governing the radiation of heat".

➤ Stefanov zakon (l. 1879):

$$j = \sigma T^4$$

➤ Wienov zakon (l. 1893):

$$\lambda_{max} T = 2.898 \times 10^{-3} \text{ m} \cdot \text{K}$$

➤ Wienov eksponentni zakon:

$$\frac{dj}{d\nu} \propto \nu^3 e^{-\beta\nu/T}$$

SIMULACIJA

Vir: internet; povzeto po Serway, Moses & Moyer, Modern Physics, Thomson Learning

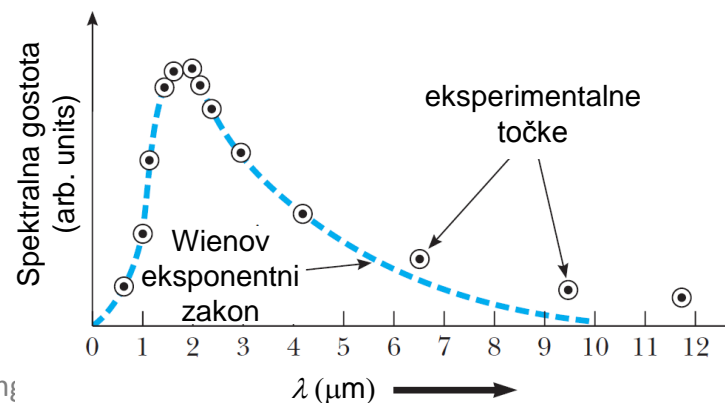

3.2 Svetloba – valovanje ali delci?

- Sevanje črnega telesa (l. 1900): kvantizacija E nivojev

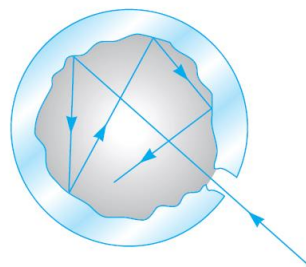

$$dj = \frac{c}{4} \frac{dE}{V} = \frac{c}{4} \bar{E} \frac{8\pi\nu^2}{c^3} d\nu$$

vs.

Planck:

Rayleigh-Jeans:

- EM valovi
- $\bar{E} = k_B T$
- $\frac{dj}{d\nu} = \frac{2\pi\nu^2}{c^2} k_B T$

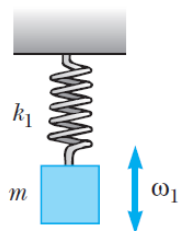

The Nobel Prize in Physics 1918



Max Karl Ernst
Ludwig Planck
Prize share: 1/1

The Nobel Prize in Physics 1918 was awarded to Max Planck "in recognition of the services he rendered to the advancement of Physics by his discovery of energy quanta".

- oscilacije naboja v stenah
- $\bar{E} = \frac{h\nu}{e^{h\nu/k_B T} - 1}$
- $\frac{dj}{d\nu} = \frac{2\pi\nu^2}{c^2} \frac{h\nu}{e^{h\nu/k_B T} - 1}$

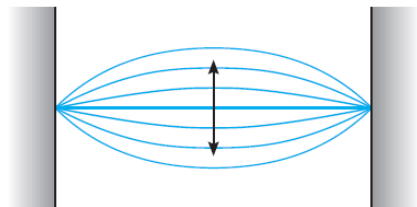
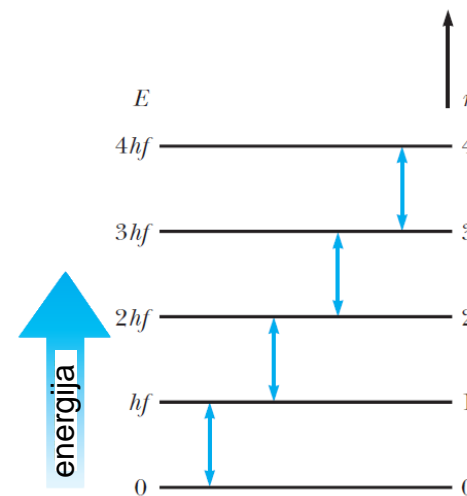

Vir: internet; povzeto po Serway, Moses & Moyer, Modern Physics, Thomson Learning, 2005

3.2 Svetloba – valovanje ali delci?

➤ Einstein: Annus Mirabilis



[Explore this journal >](#)

Article

Über einen die Erzeugung und Verwandlung des Lichtes betreffenden heuristischen Gesichtspunkt

A. Einstein

Teorija kvantizacije svetlobe: fotoefekt
A. Einstein, Ann. Physik **322**, 132 (1905)



Albert Einstein



[Explore this journal >](#)

Article

Über die von der molekularkinetischen Theorie der Wärme geforderte Bewegung von in ruhenden Flüssigkeiten suspendierten Teilchen

A. Einstein

Brownovo gibanje: realnost atomov
A. Einstein, Ann. Physik **322**, 549 (1905)



[Explore this journal >](#)

Article

Zur Elektrodynamik bewegter Körper

A. Einstein

Posebna teorija relativnosti:
A. Einstein, Ann. Physik **322**, 891 (1905)



[Explore this journal >](#)

Article

Ist die Trägheit eines Körpers von seinem Energieinhalt abhängig?

A. Einstein

Mirovna energija: $E = mc^2$
A. Einstein, Ann. Physik **323**, 639 (1905)



3.2 Svetloba – valovanje ali delci?

➤ Fotoefekt (l. 1905): kvantizacija svetlobe

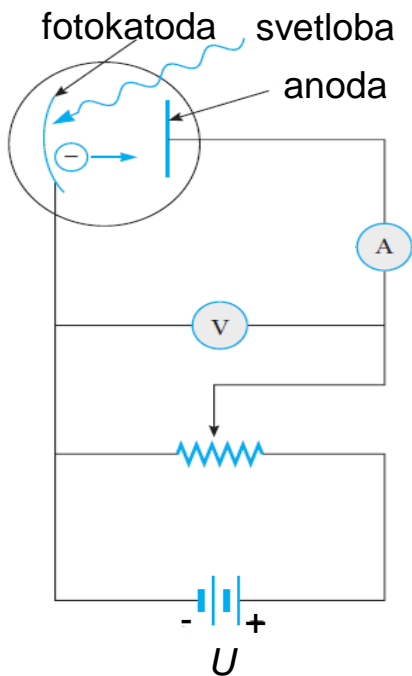

The Nobel Prize in Physics 1921

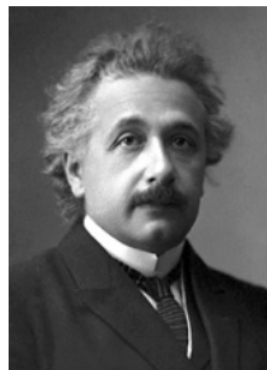

Albert Einstein
Prize share: 1/1

The Nobel Prize in Physics 1921 was awarded to Albert Einstein "for his services to Theoretical Physics, and especially for his discovery of the law of the photoelectric effect".

SIMULACIJA

$$W_{kin}^{max} = eU_z = h\nu - \phi$$

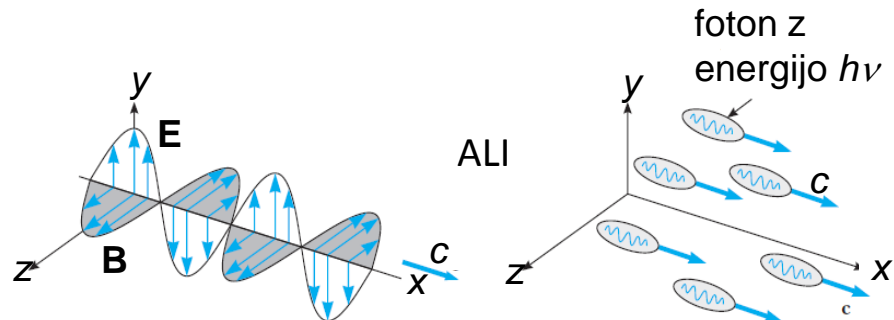
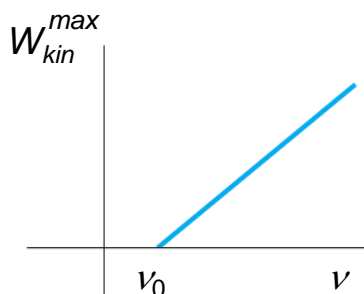
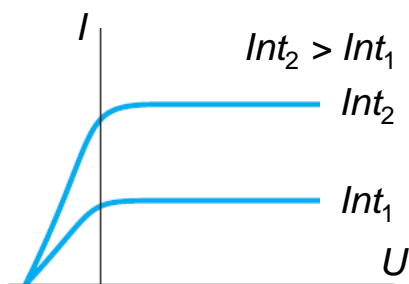

Vir: internet; povzeto po Serway, Moses & Moyer, Modern Physics, Thomson Learning, 2005

3.2 Svetloba – valovanje ali delci?

➤ Comptonovo sipanje (l. 1923):

$$\lambda' - \lambda = \frac{h}{m_e c} (1 - \cos \theta)$$

The Nobel Prize in Physics 1927



Arthur Holly Compton
Prize share: 1/2



Charles Thomson Rees Wilson
Prize share: 1/2

The Nobel Prize in Physics 1927 was divided equally between Arthur Holly Compton *"for his discovery of the effect named after him"* and Charles Thomson Rees Wilson *"for his method of making the paths of electrically charged particles visible by condensation of vapour"*.

Vir: internet; Serway, povzeto po Moses & Moyer, Modern Physics, Thomson Learning, 2005

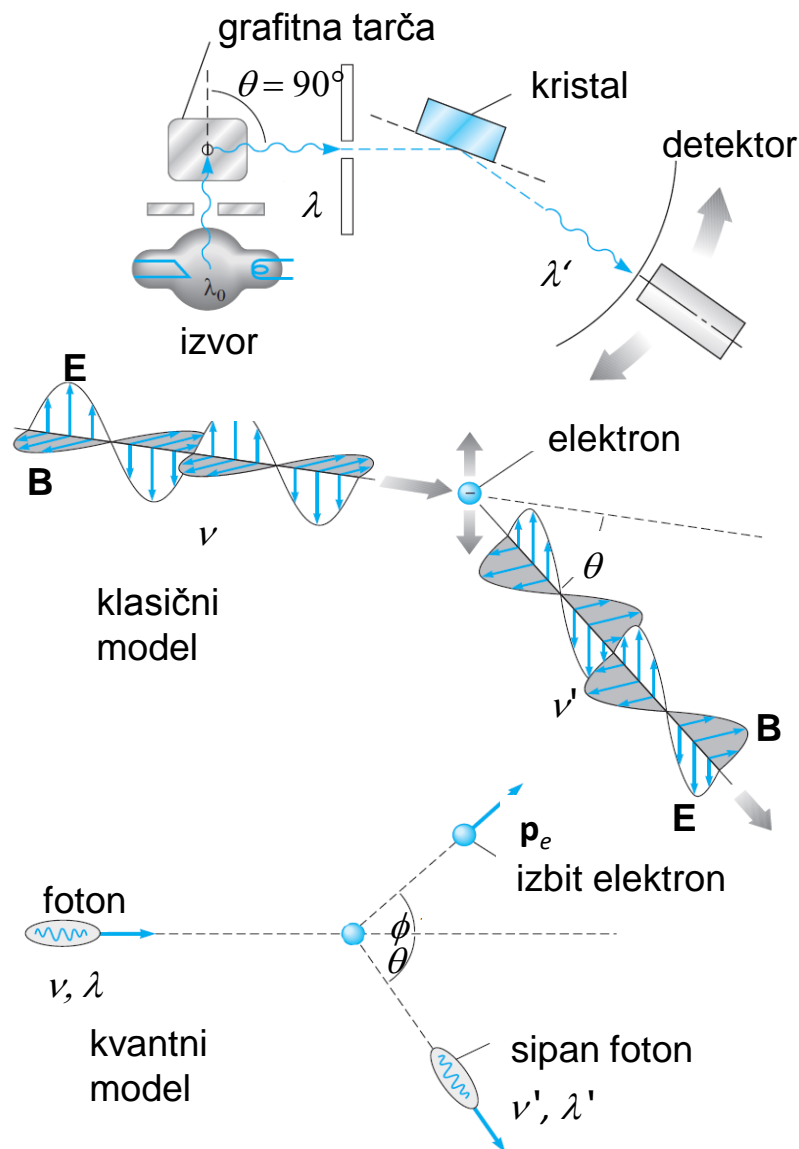

3.2 Svetloba – valovanje ali delci?

➤ Zavorno sevanje:

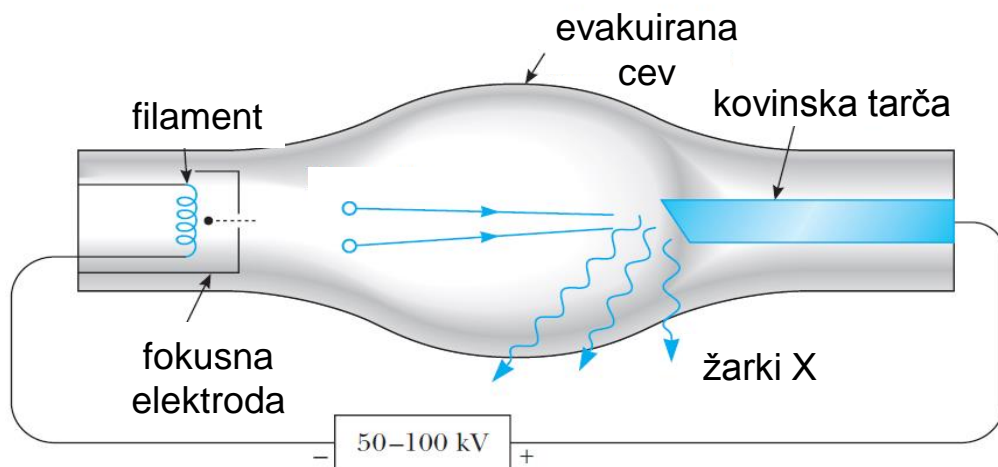
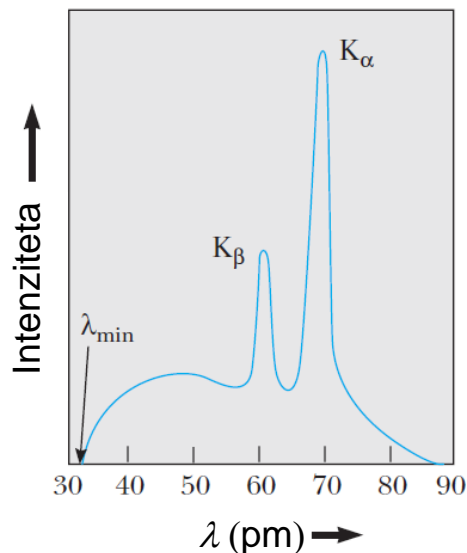

The Nobel Prize in Physics 1901



Wilhelm Conrad Röntgen
Prize share: 1/1

The Nobel Prize in Physics 1901 was awarded to Wilhelm Conrad Röntgen "in recognition of the extraordinary services he has rendered by the discovery of the remarkable rays subsequently named after him".

$$\lambda_{\min} = \frac{hc}{eU}$$

Vir: povzeto po Serway, Moses & Moyer, Modern Physics, Thomson Learning, 2005

3.2 Svetloba – valovanje ali delci?

- Delčno-valovna komplementarnost:

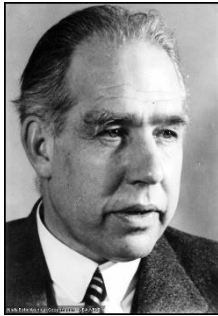

Niels Bohr

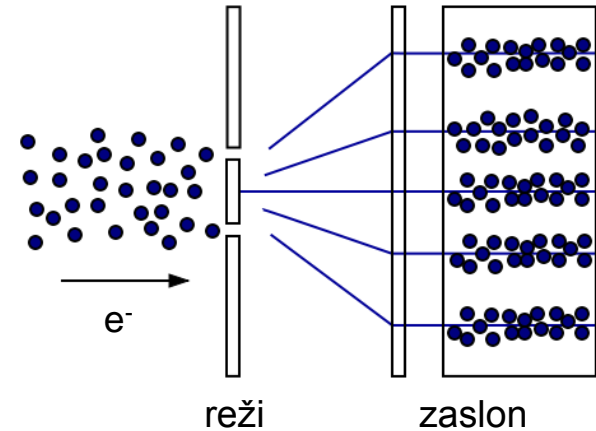

Every process can be interpreted either in terms of corpuscles or in terms of waves, but on the other hand it is beyond our power to produce proof that it is actually corpuscles or waves with which we are dealing, for we cannot simultaneously determine all the other properties which are distinctive of a corpuscle or of a wave, as the case may be.

3.3 Atomska struktura snovi in Bohrov model atoma

- M. Faraday (l. 1833): zakon elektrolize

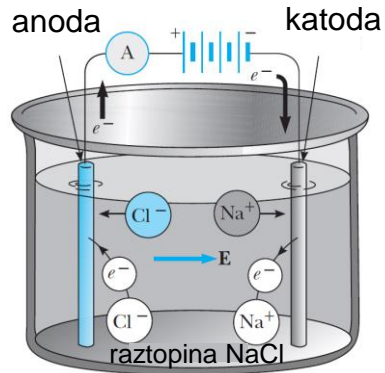

The Nobel Prize in Physics 1906



Joseph John Thomson
Prize share: 1/1

The Nobel Prize in Physics 1906 was awarded to J.J. Thomson *"in recognition of the great merits of his theoretical and experimental investigations on the conduction of electricity by gases"*.

- J. J. Thomson (l. 1897): odkritje elektrona (e/m)

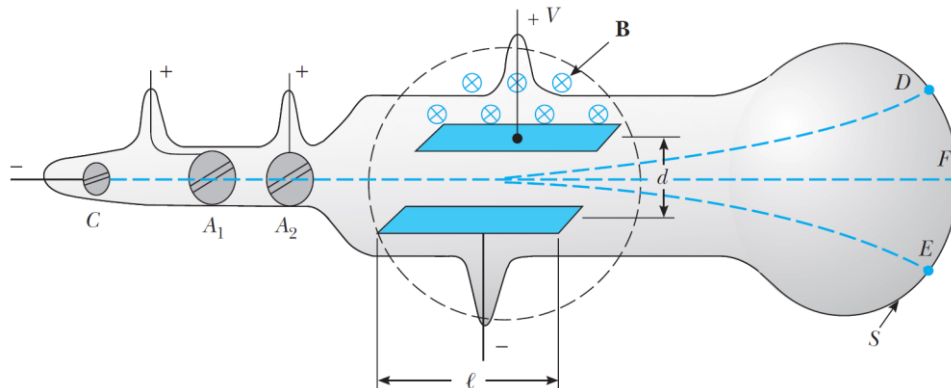

Vir: internet, povzeto po Serway, Moses & Moyer, Modern Physics, Thomson Learning, 2005

3.3 Atomska struktura snovi in Bohrov model atoma

- R. Millikan (l. 1909): določitev osnovnega naboja

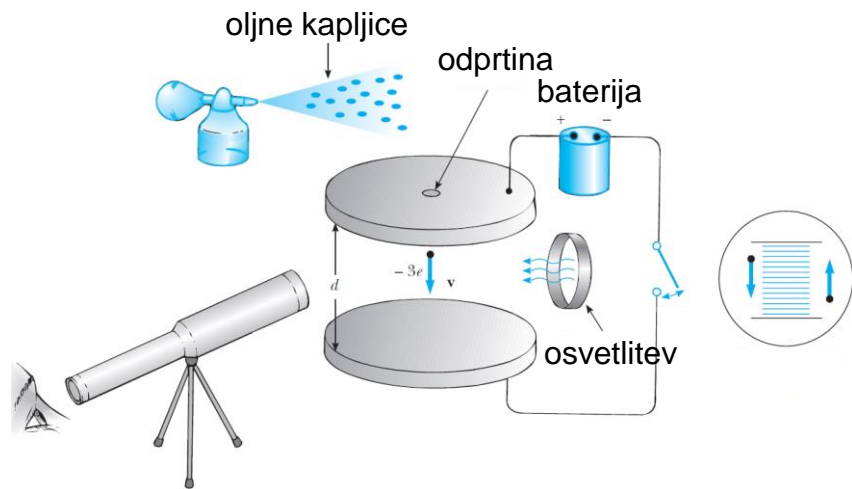

- E. Rutherford (l. 1913): planetarni model atoma

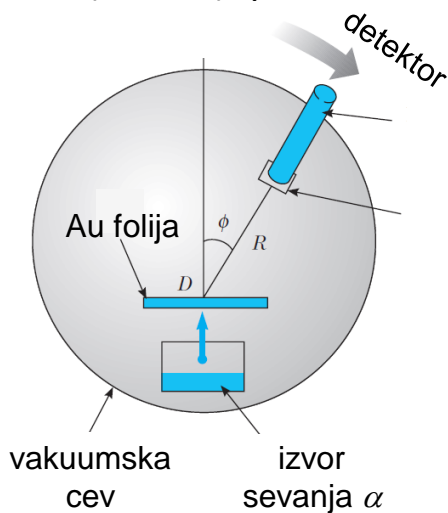

SIMULACIJA

Vir: internet povzeto po Serway, Moses & Moyer, Modern Physics, Thomson Learning, 2005

The Nobel Prize in Physics 1923



Robert Andrews Millikan

Prize share: 1/1

The Nobel Prize in Physics 1923 was awarded to Robert A. Millikan "for his work on the elementary charge of electricity and on the photoelectric effect".



3.3 Atomska struktura snovi in Bohrov model atoma

➤ Gustav R. Kirchhoff (l. 1859):
atomske spektralne črte

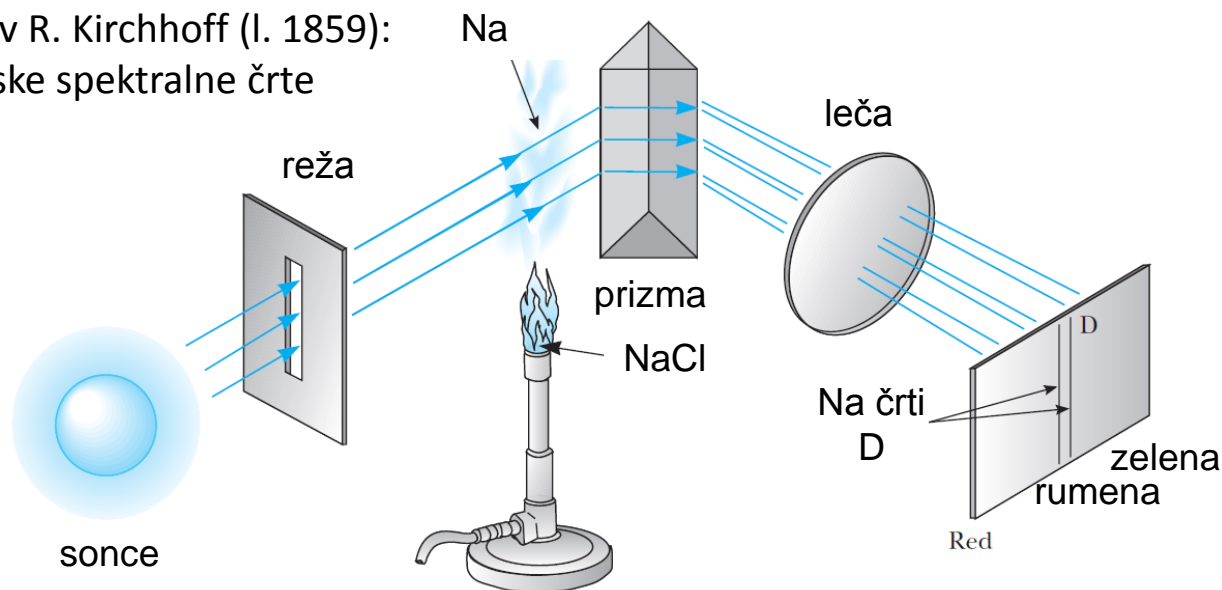

Gustav R. Kirchhoff

1. Balmerjeva serija: $\lambda = C_2 \frac{n^2}{n^2 - 2^2} \quad n = 3, 4, 5, \dots$

2. ostale serije: $\frac{1}{\lambda} = R \left(\frac{1}{n_f^2} - \frac{1}{n_i^2} \right)$

Lymanova serija (UV)	$n_f = 1$	$n_i = 2, 3, 4, \dots$
Balmerjeva serija (VIS-UV)	$n_f = 2$	$n_i = 3, 4, 5, \dots$
Paschenova serija (IR)	$n_f = 3$	$n_i = 4, 5, 6, \dots$
Brackettova serija (IR)	$n_f = 4$	$n_i = 5, 6, 7, \dots$
Pfundova serija (IR)	$n_f = 5$	$n_i = 6, 7, 8, \dots$

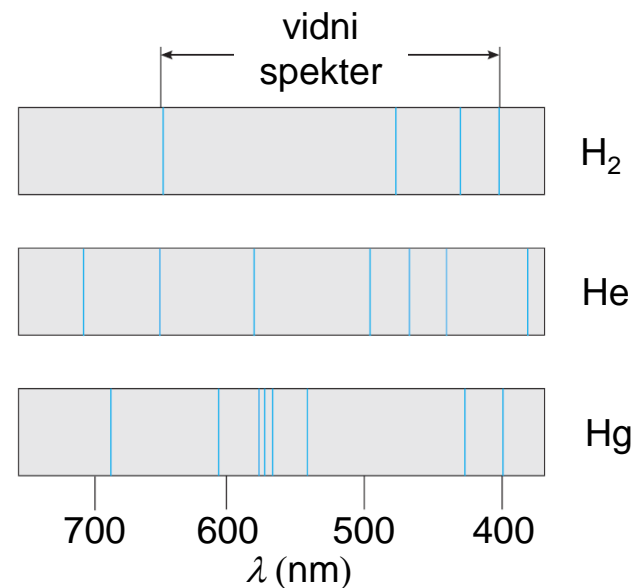

Vir: povzeto po Serway, Moses & Moyer, Modern Physics, Thomson Learning, 2005

3.3 Atomska struktura snovi in Bohrov model atoma

➤ Bohrov (kvantni) model atoma (l. 1913): $mvr_n = n\hbar$, $n = 1, 2, 3, \dots$

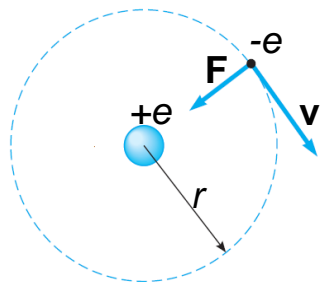

kvantizacija vrtilne količine

kvantizacija energij

$$E_n = -\frac{1}{2} \frac{e^2}{4\pi\epsilon_0 r_B} \frac{Z^2}{n^2}$$

kvantizacija radijev

$$r_n = \frac{n^2}{Z} r_B, \quad r_B = \frac{4\pi\epsilon_0 \hbar^2}{me^2}$$

The Nobel Prize in Physics 1922



Niels Henrik David Bohr

Prize share: 1/1

The Nobel Prize in Physics 1922 was awarded to Niels Bohr "for his services in the investigation of the structure of atoms and of the radiation emanating from them".

Vir: internet; povzeto po Serway, Moses & Moyer, Modern Physics, Thomson Learning, 2005

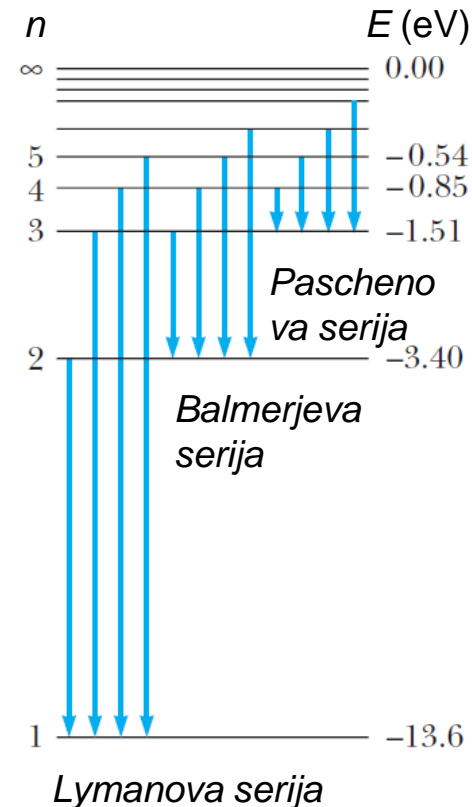
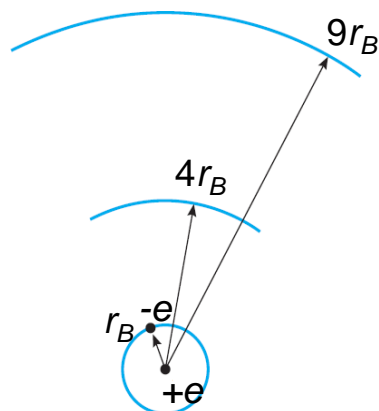



MODERNA FIZIKA

Kvantna mehanika 2 Kvantnomehanski opis

4.1 Delčno-valovna dualnost materije

➤ de Brogliejevi valovi (l. 1923): materija kot valovanje

$$E = mc^2 = \sqrt{(cp)^2 + (m_0c^2)^2}$$

relativnost

za foton
 $m_0 = 0$

$$p = \frac{E}{c}$$

$$\lambda = \frac{h}{p}$$

de Brogliejeva hipoteza

$$\lambda = \frac{h}{p} = \frac{h}{mv}$$

za masivni delec?

The Nobel Prize in Physics 1929



Prince Louis-Victor
Pierre Raymond de
Broglie
Prize share: 1/1

The Nobel Prize in Physics 1929 was awarded to Louis de Broglie
"for his discovery of the wave nature of electrons".

Vir: internet; povzeto po Serway, Moses & Moyer, Modern Physics, Thomson Learning, 2005

$$E = h\nu = \frac{hc}{\lambda}$$

fotoefekt

- Konstruktivna interferenca valov
- Kvantizacija vrtilne količine v atomu

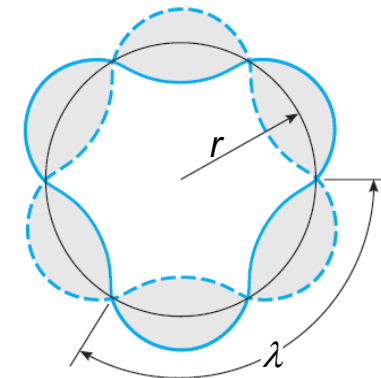

4.1 Delčno-valovna dualnost materije

- Eksperiment Davisonna in Germerja (l. 1927):

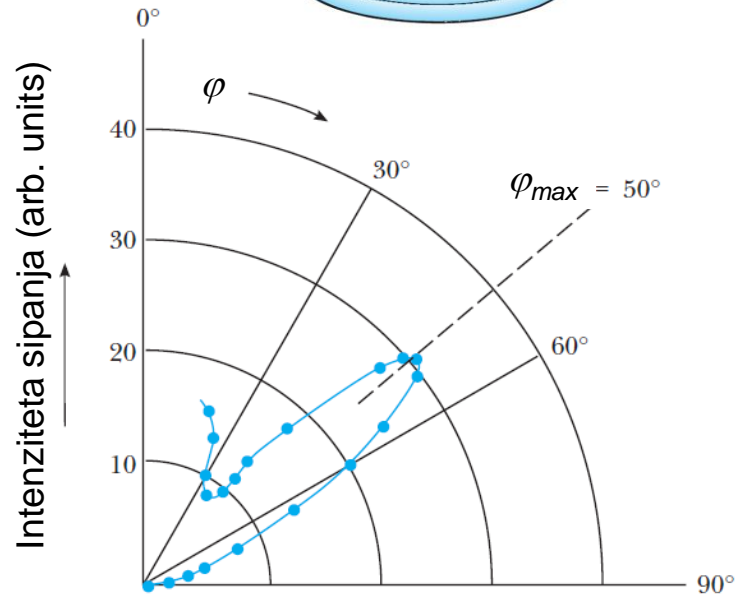
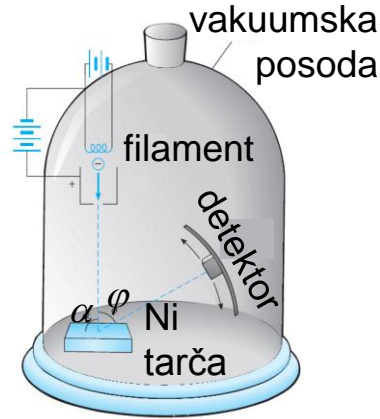

- Načelo komplementarnosti

Vir: povzeto po Serway, Moses & Moyer, Modern Physics, Thomson Learning, 2005

The Nobel Prize in Physics 1937



Clinton Joseph Davisson
Prize share: 1/2



George Paget Thomson
Prize share: 1/2

The Nobel Prize in Physics 1937 was awarded jointly to Clinton Joseph Davisson and George Paget Thomson *"for their experimental discovery of the diffraction of electrons by crystals"*

$$d \sin \varphi = n \lambda$$

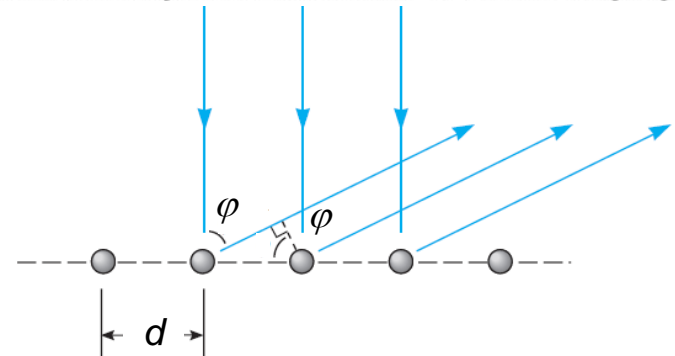

4.2 Valovni paket

➤ Superpozicija ravnih valov:

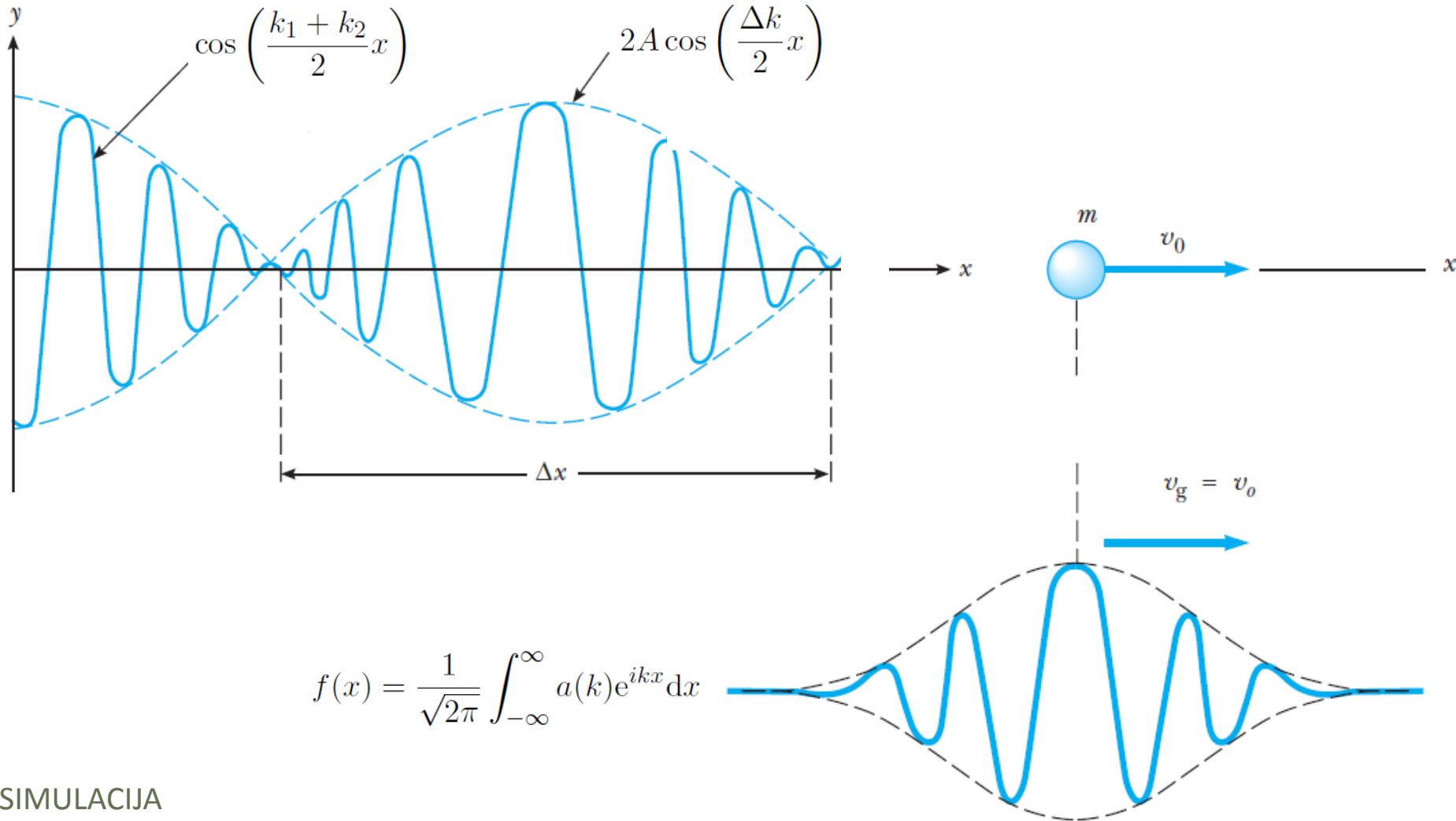

SIMULACIJA

Vir: povzeto po Serway, Moses & Moyer, Modern Physics, Thomson Learning, 2005

4.3 Heisenbergovo načelo nedoločenosti

- Nedoločenost lege in gibalne količine (l. 1927):

$$\Delta x \Delta p \geq \frac{\hbar}{2}$$

$$\Delta E \Delta t \geq \frac{\hbar}{2}$$

The Nobel Prize in Physics 1932



Werner Karl Heisenberg
Prize share: 1/1

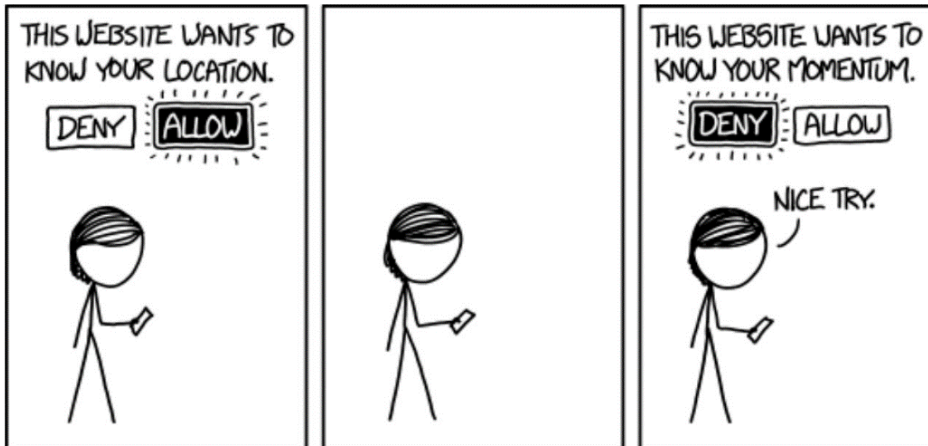

The Nobel Prize in Physics 1932 was awarded to Werner Heisenberg "for the creation of quantum mechanics, the application of which has, inter alia, led to the discovery of the allotropic forms of hydrogen".

4.4 Valovna funkcija

- Bornova interpretacija valovne funkcije (I. 1925):

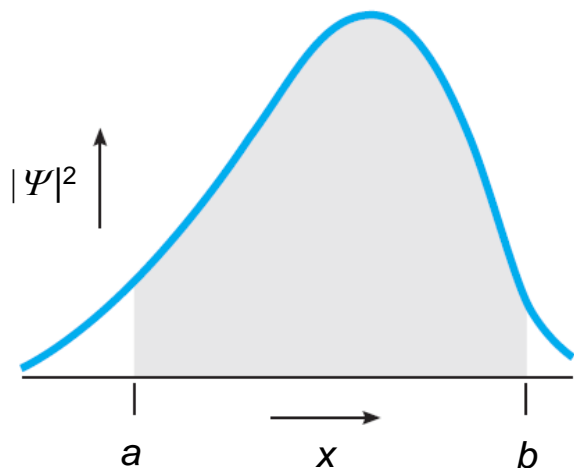

$$P(x)dx = |\Psi(x, t)|^2 dx \quad P = \int_a^b |\Psi(x, t)|^2 dx$$

$$\int_{-\infty}^{\infty} |\Psi(x, t)|^2 dx = 1$$

- Gibanje prostega delca – RAVNI VAL

$$\Psi_k(x, t) = Ae^{i(kx - \omega t)} = A [\cos(kx - \omega t) + i \sin(kx - \omega t)]$$

$$k = \frac{p}{\hbar} \quad \omega = \frac{E}{\hbar}$$

$$|\Psi_k(x, t)|^2 = |A|^2$$

Vir: povzeto po Serway, Moses & Moyer, Modern Physics, Thomson Learning, 2005

The Nobel Prize in Physics 1954



Max Born
Prize share: 1/2



Walther Bothe
Prize share: 1/2

The Nobel Prize in Physics 1954 was divided equally between Max Born *"for his fundamental research in quantum mechanics, especially for his statistical interpretation of the wavefunction"* and Walther Bothe *"for the coincidence method and his discoveries made therewith"*.

4.4 Valovna funkcija

➤ Sipanje delcev (elektronov) na dveh režah:

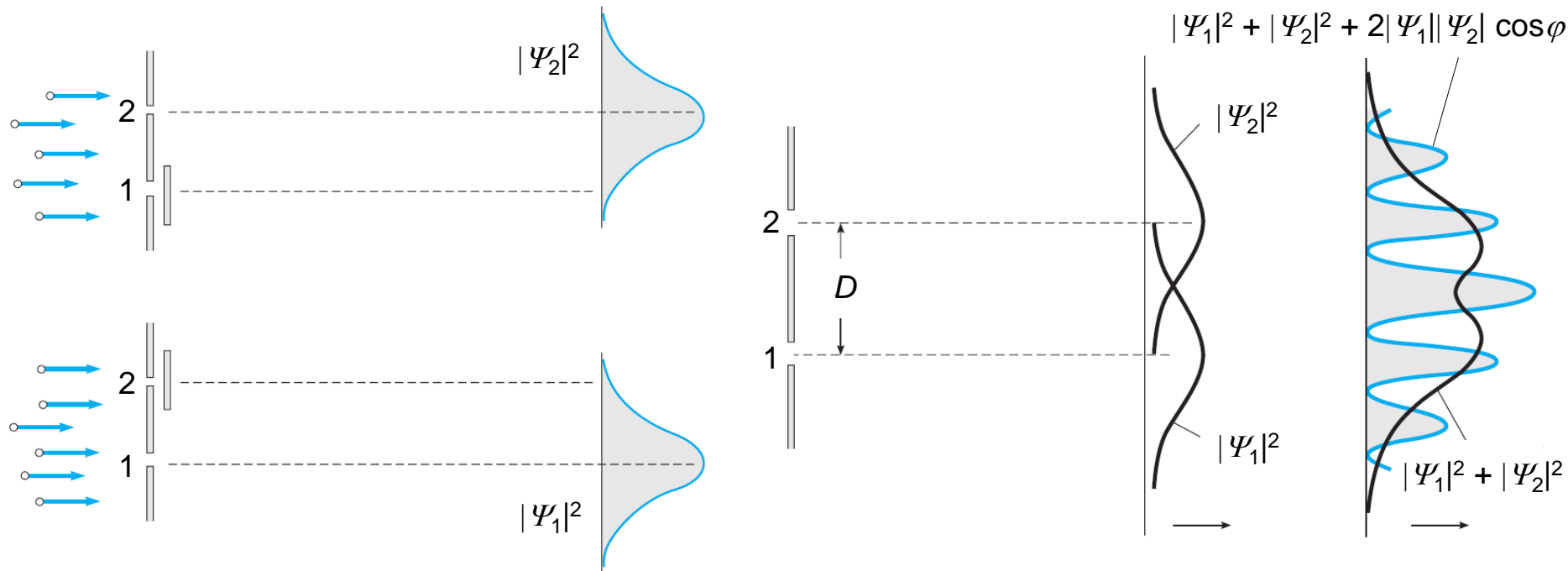

Primer	Valovna funkcija	Meritve na zaslonu
Izmerimo, da gre elektron skozi režo 1 ali režo 2:	Ψ_1 ali Ψ_2	$ \Psi_1 ^2 + \Psi_2 ^2$
Meritev, skozi katero režo gre elektron, ni izvedena:	$\Psi_1 + \Psi_2$	$ \Psi_1 ^2 + \Psi_2 ^2 + 2 \Psi_1 \Psi_2 \cos \varphi$

SIMULACIJA

Vir: povzeto po Serway, Moses & Moyer, Modern Physics, Thomson Learning, 2005

4.5 Schrödingerjeva enačba

- Valovna enačba v KM (l. 1926): :

$$-\frac{\hbar^2}{2m} \frac{\partial^2 \Psi(x, t)}{\partial x^2} + U(x) \Psi(x, t) = i\hbar \frac{\partial \Psi(x, t)}{\partial t}$$

- Stacionarna stanja: $\Psi(x, t) = \psi(x)\phi(t)$

$$-\frac{\hbar^2}{2m} \frac{d^2 \psi(x)}{dx^2} \frac{1}{\psi(x)} + U(x) = i\hbar \frac{d\phi(t)}{dt} \frac{1}{\phi(t)}$$

$$i\hbar \frac{d\phi(t)}{dt} = E\phi(t)$$

$$\phi(t) = e^{-iEt/\hbar} = e^{-i\omega t}$$

$$-\frac{\hbar^2}{2m} \frac{d^2 \psi(x)}{dx^2} + U(x)\psi(x) = E\psi(x)$$

The Nobel Prize in Physics 1933



Erwin Schrödinger
Prize share: 1/2



Paul Adrien Maurice Dirac
Prize share: 1/2

The Nobel Prize in Physics 1933 was awarded jointly to Erwin Schrödinger and Paul Adrien Maurice Dirac *"for the discovery of new productive forms of atomic theory"*

SIMULACIJA

Vir: povzeto po Serway, Moses & Moyer, Modern Physics, Thomson Learning, 2005



MODERNA FIZIKA

Kvantna mehanika 3 Gibanje v 1D

5.1 Delec v neskončni potencialni jami

- Stacionarna Schrödingerjeva enačba:

$$\frac{d^2\psi(x)}{dx^2} = -\frac{2mE}{\hbar^2}\psi(x) = -k^2\psi(x)$$

$$\psi_n = \sqrt{\frac{2}{L}} \sin\left(\frac{n\pi}{L}x\right)$$

$$E_n = \frac{\hbar^2 k_n^2}{2m} = \frac{\hbar^2 \pi^2}{2mL^2} n^2$$

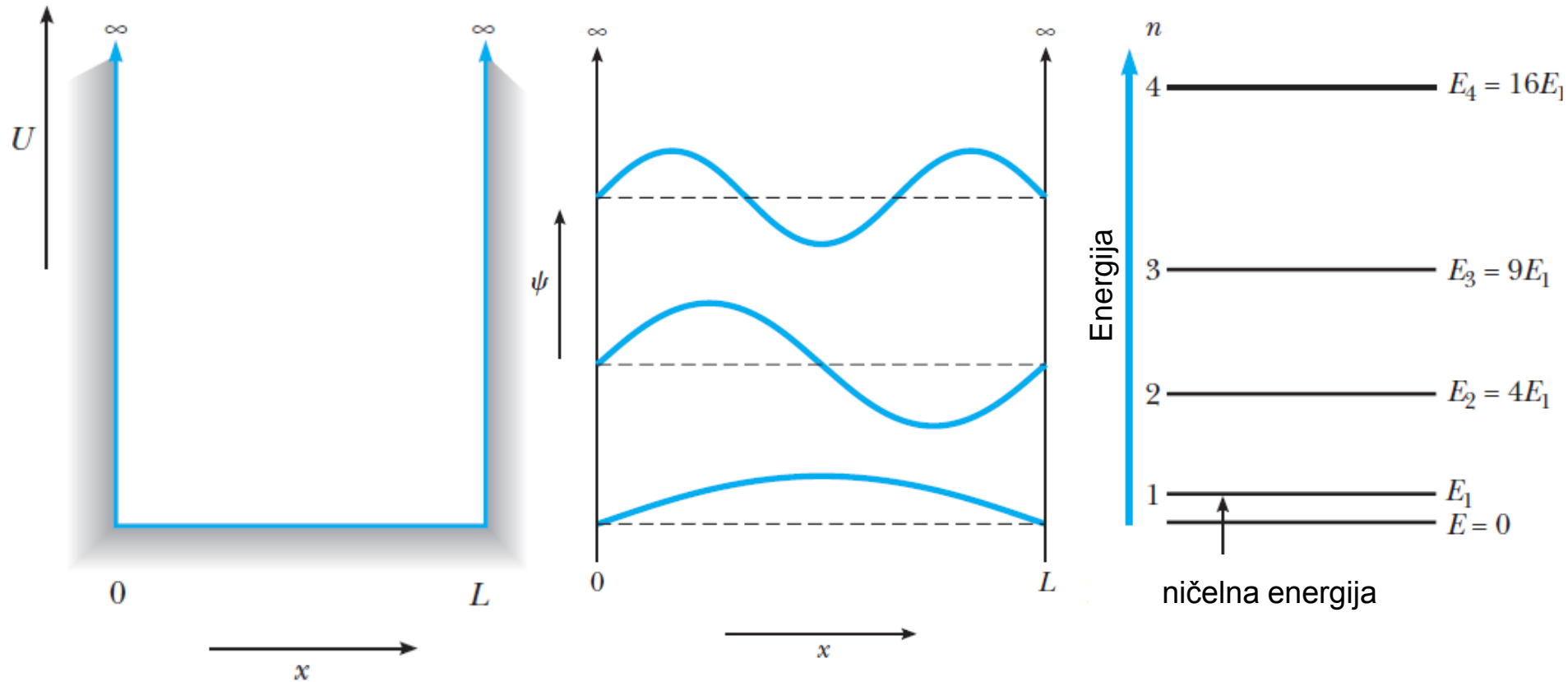

SIMULACIJA

Vir: internet; povzeto po Serway, Moses & Moyer, Modern Physics, Thomson Learning, 2005

5.1 Delec v neskončni potencialni jami

➤ CCD detektor fotonov:

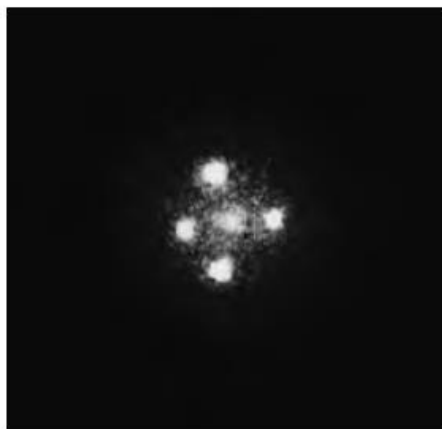
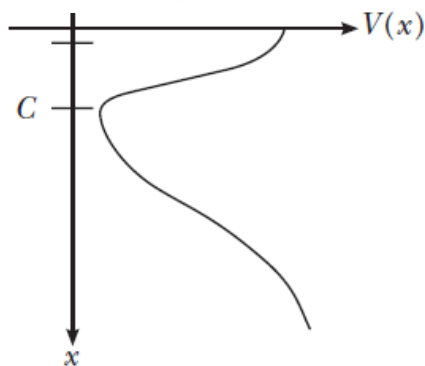
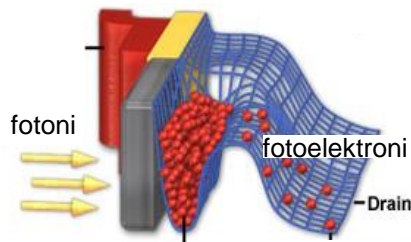
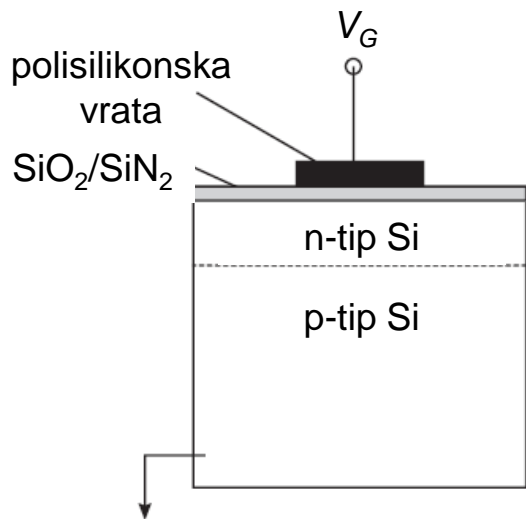

Hubblor teleskop



foto-elektronika

The Nobel Prize in Physics 2009



Photo: U. Montan
Charles Kuen Kao
Prize share: 1/2

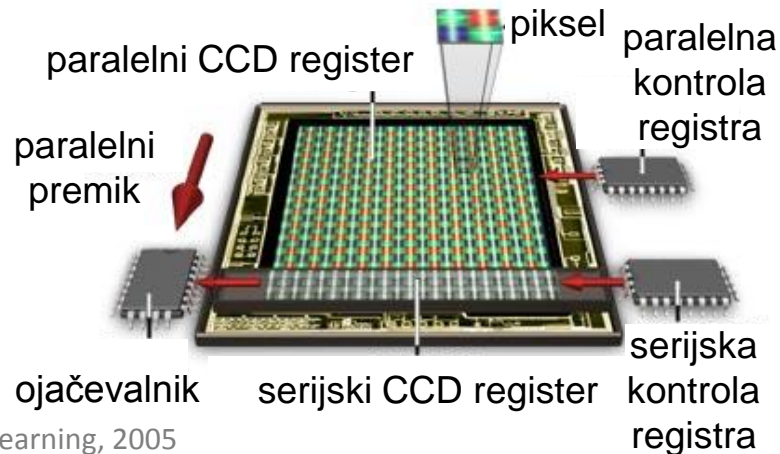

Photo: U. Montan
Willard S. Boyle
Prize share: 1/4



Photo: U. Montan
George E. Smith
Prize share: 1/4

The Nobel Prize in Physics 2009 was divided, one half awarded to Charles Kuen Kao "for groundbreaking achievements concerning the transmission of light in fibers for optical communication", the other half jointly to Willard S. Boyle and George E. Smith "for the invention of an imaging semiconductor circuit - the CCD sensor".



Vir: internet; povzeto po Serway, Moses & Moyer, Modern Physics, Thomson Learning, 2005

5.2 Kvantni harmonski oscilator

➤ Osnovno stanje:

$$\frac{d^2\psi(x)}{dx^2} = \frac{2m}{\hbar^2} \left(\frac{1}{2}m\omega^2 x^2 - E \right) \psi(x)$$

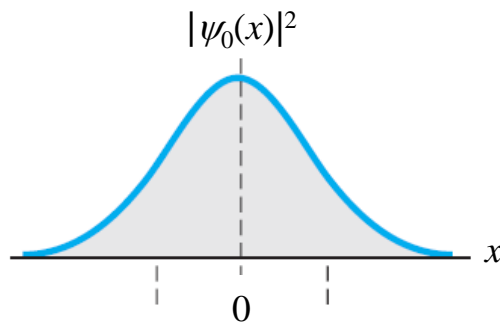
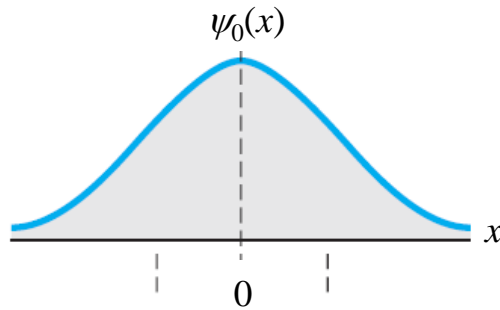

$$\psi_0 = \sqrt[4]{\frac{m\omega}{\hbar\pi}} \exp\left(-\frac{m\omega}{2\hbar} x^2\right)$$

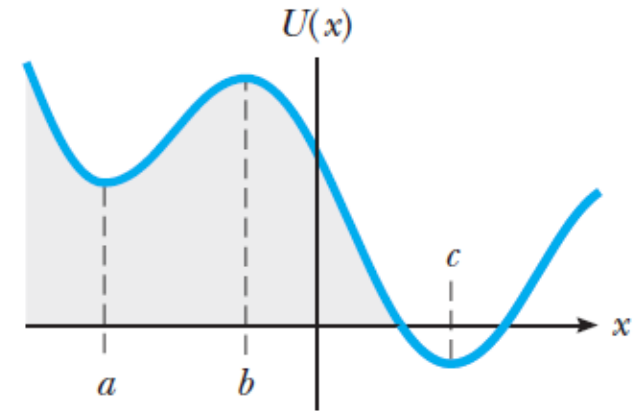

stabilno nestabilno stabilno

$$\begin{aligned} U(x) &= U(c) + \frac{1}{2}K(x - c)^2 \\ &= U(c) + \frac{1}{2}m\omega^2(x - c)^2 \end{aligned}$$

Vir: Serway, povzeto po Moses & Moyer, Modern Physics, Thomson Learning, 2005

5.2 Kvantni harmonski oscilator

➤ Vzbujena stanja:

$$\psi_n = \sqrt{\frac{m\omega}{\hbar\pi}} \frac{1}{\sqrt{2^n n!}} \exp\left(-\frac{m\omega}{2\hbar}x^2\right) H_n\left(\sqrt{\frac{m\omega}{\hbar}}x\right)$$

$$E_n = \left(n + \frac{1}{2}\right) \hbar\omega$$

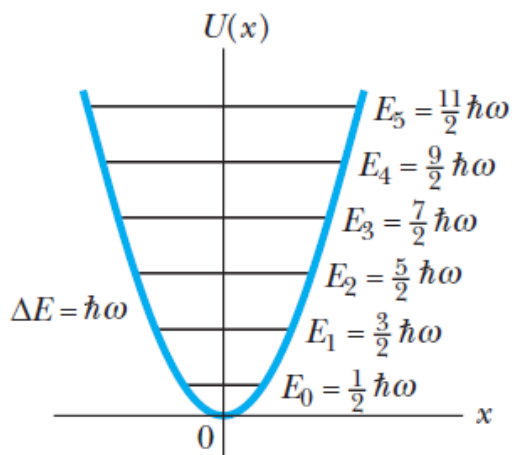

SIMULACIJA

Vir: internet; povzeto po Serway, Moses & Moyer, Modern Physics, Thomson Learning, 2005

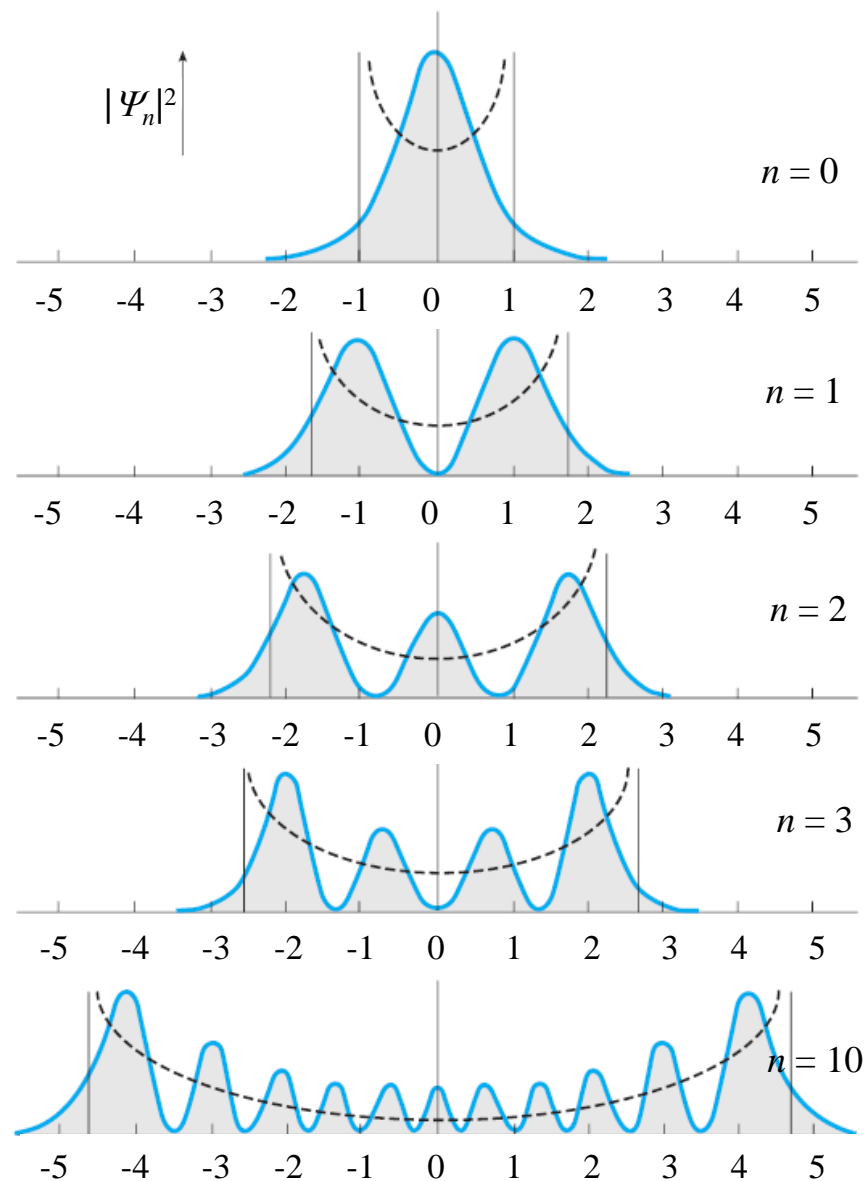

5.3 Povprečne vrednosti opazljivk in operatorji

➤ Povprečna lega:

$$\langle x \rangle = \int_{-\infty}^{\infty} x |\Psi(x, t)|^2 dx$$

➤ Povprečje funkcije $f(x)$:

$$\langle f(x) \rangle = \int_{-\infty}^{\infty} f(x) |\Psi(x, t)|^2 dx$$

➤ Povprečna gibalna količina:

$$\langle p \rangle = m \frac{d\langle x \rangle}{dt} = \int_{-\infty}^{\infty} \Psi^*(x, t) \left(-i\hbar \frac{\partial}{\partial x} \right) \Psi(x, t) dx$$

➤ Opazljivka: Q

➤ Operator: \hat{Q}

$$\langle Q \rangle = \int_{-\infty}^{\infty} \Psi^*(x, t) \hat{Q} \Psi(x, t) dx$$

Opazljivka	Simbol	Operator
Lega	x	x
Gibalna količina	p	$-i\hbar \frac{\partial}{\partial x}$
Potencialna energija	U	$U(x)$
Kinetična energija	W_{kin}	$-\frac{\hbar^2}{2m} \frac{\partial^2}{\partial x^2}$
Hamiltonka	H	$-\frac{\hbar^2}{2m} \frac{\partial^2}{\partial x^2} + U(x)$
Polna energija	E	$i\hbar \frac{\partial}{\partial t}$

5.4 Razvoj valovnih funkcij

- Razvoj po bazi ortonormiranih lastnih funkcij: $\int_{-\infty}^{\infty} \psi_m^*(x)\psi_n(x)dx = \delta_{m,n}$

$$\Psi(x, t = 0) = \sum_n c_n \psi_n(x)$$
$$c_n = \int_{-\infty}^{\infty} \psi_n^*(x)\Psi(x, t = 0)dx$$
$$\sum_n |c_n|^2 = 1$$

SIMULACIJA

- Časovni razvoj:

$$\Psi(x, t) = \sum_n c_n \psi_n(x) e^{-i\frac{E_n}{\hbar}t}$$

$$P(x, t) = \Psi^*(x, t)\Psi(x, t)$$
$$= \sum_n |c_n|^2 |\psi_n(x)|^2 + \sum_{m,n} c_m^* c_n \psi_m^*(x)\psi_n(x) e^{i\frac{E_m - E_n}{\hbar}t}$$

SIMULACIJA

- Povprečna vrednost energije:

$$\langle E \rangle = \int_{-\infty}^{\infty} \Psi^*(x, t)\hat{H}\Psi(x, t)dx = \sum_n |c_n|^2 E_n$$

- Kolaps valovne funkcije:

SIMULACIJA

Vir: internet

5.5 Potencialna stopnica

➤ Operator gostote toka delcev:

$$\hat{j} = -\frac{i\hbar}{2m} \left(\Psi^* \frac{d\Psi}{dx} - \frac{d\Psi^*}{dx} \Psi \right)$$

➤ ODBOJNOST:

$$R = \left| \frac{k_1 - k_2}{k_1 + k_2} \right|^2 \quad k_1 = \frac{\sqrt{2mE}}{\hbar}$$

➤ PREPUSTNOST:

$$T = \frac{4k_1 k_2}{|k_1 + k_2|^2} \quad k_2 = \frac{\sqrt{2m(E - V_0)}}{\hbar}$$

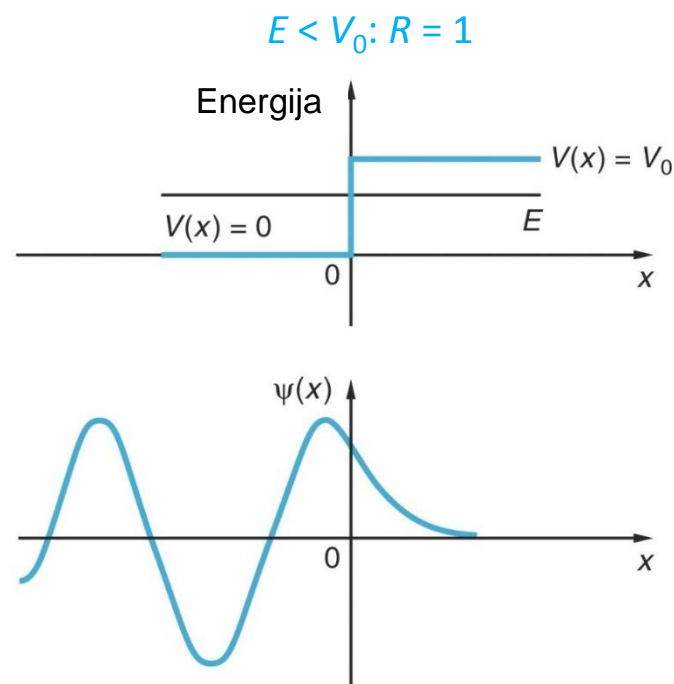
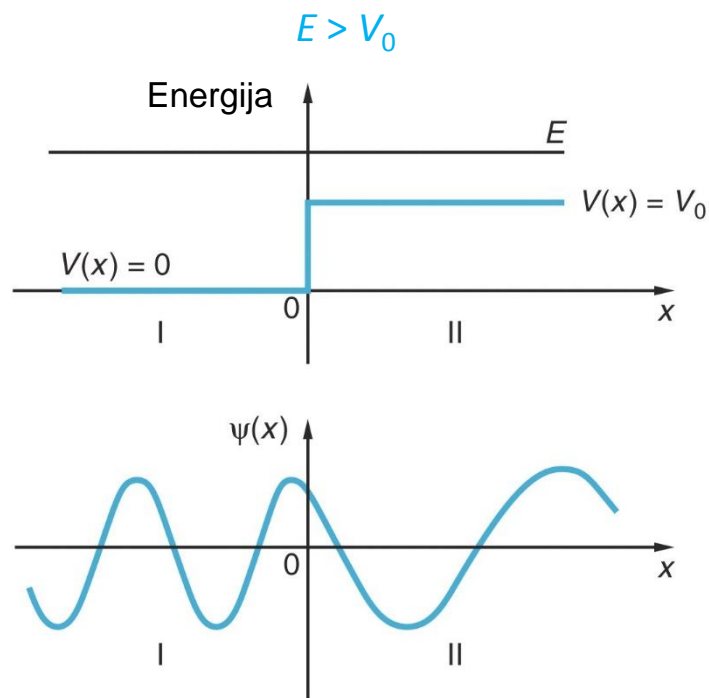

SIMULACIJA

Vir: internet; povzeto po Tipler & Llevellyn, Modern Physics, W. H. Freeman and Company, 2012

5.6 Potencialna plast

➤ ODBOJNOST:
$$R = \frac{\left(\frac{k_2}{2k_1} - \frac{k_1}{2k_2}\right)^2 \sin^2(k_2 L)}{1 + \left(\frac{k_2}{2k_1} - \frac{k_1}{2k_2}\right)^2 \sin^2(k_2 L)}$$

$$k_1 = \frac{\sqrt{2mE}}{\hbar}$$

➤ PREPUSTNOST:
$$T = \frac{1}{1 + \left(\frac{k_2}{2k_1} - \frac{k_1}{2k_2}\right)^2 \sin^2(k_2 L)}$$

$$k_2 = \frac{\sqrt{2m(E - V_0)}}{\hbar}$$

➤ TUNELIRANJE: $E < V_0$; $R \neq 1$

$$T = \frac{1}{1 + \left(\frac{\kappa}{2k_1} + \frac{k_1}{2\kappa}\right)^2 \sinh^2(\kappa L)} \quad \kappa = \frac{\sqrt{2m(V_0 - E)}}{\hbar}$$

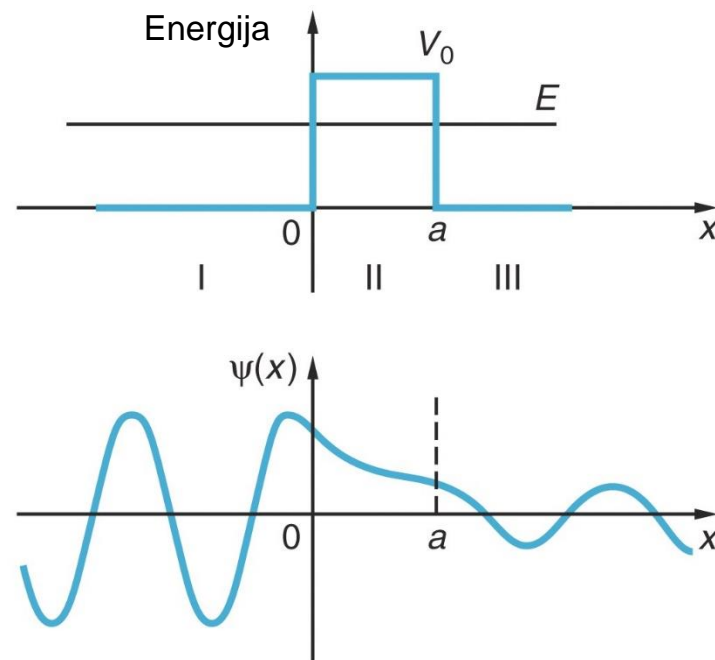
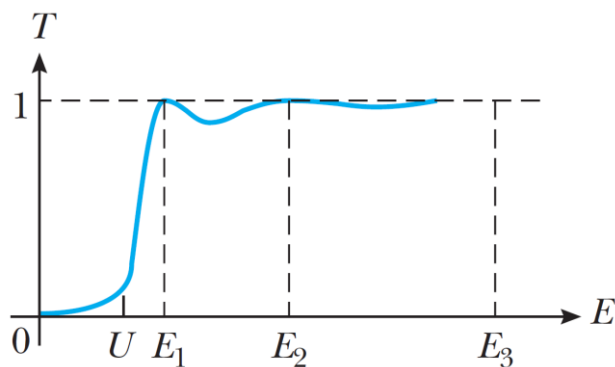

SIMULACIJA

Vir: internet; povzeto po Tipler & Llevellyn, Modern Physics, W. H. Freeman and Company, 2012

5.6 Potencialna plast

➤ Primeri tuneliranja:

1. RAZPAD α : $T(E) = \exp\left(-4\pi Z\sqrt{\frac{E_0}{E}} + 8\sqrt{\frac{8R}{r_0}}\right)$

$$r_0 = \frac{4\pi\epsilon_0\hbar^2}{m_\alpha e^2} \quad E_0 = \frac{e^2}{8\pi\epsilon_0 r_0}$$

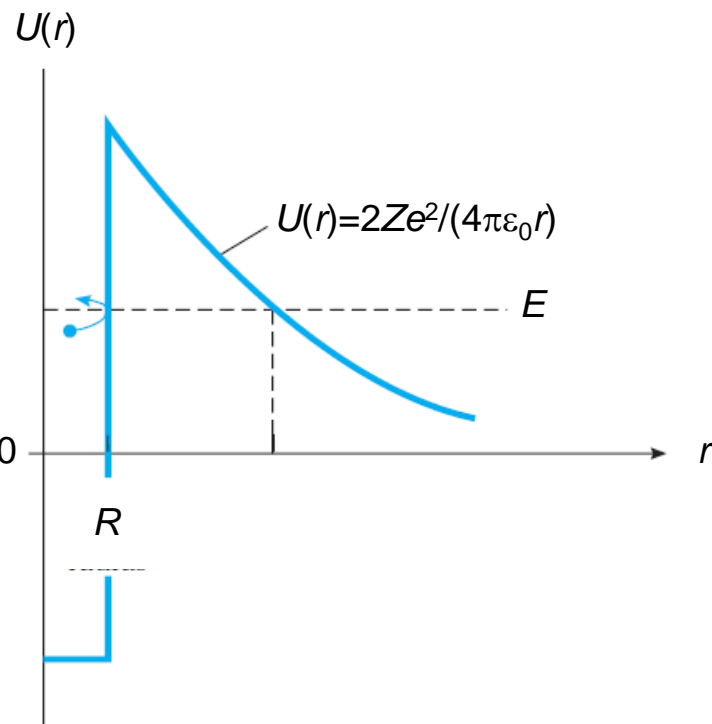
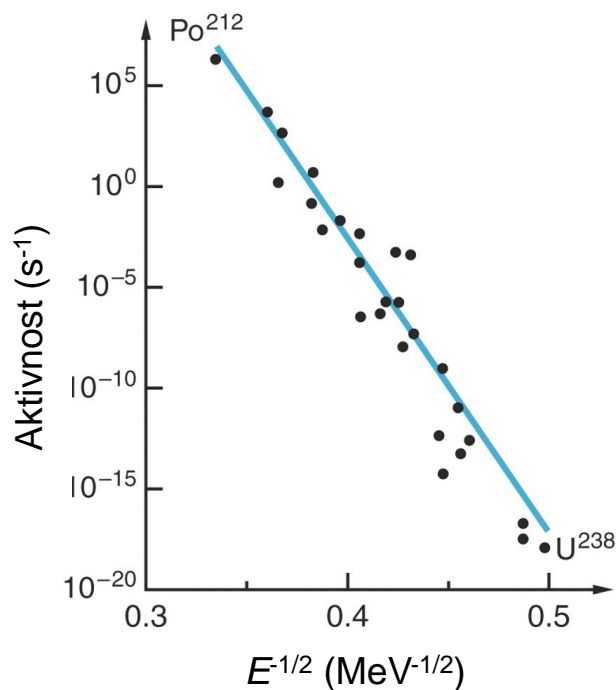

Vir: povzeto po Serway, Moses & Moyer, Modern Physics, Thomson Learning, 2005; Tipler & Llewellyn, Modern Physics, W. H. Freeman and Company, 2012

5.6 Potencialna plast

2. INVERZIJA NH_3 (amonijev maser):

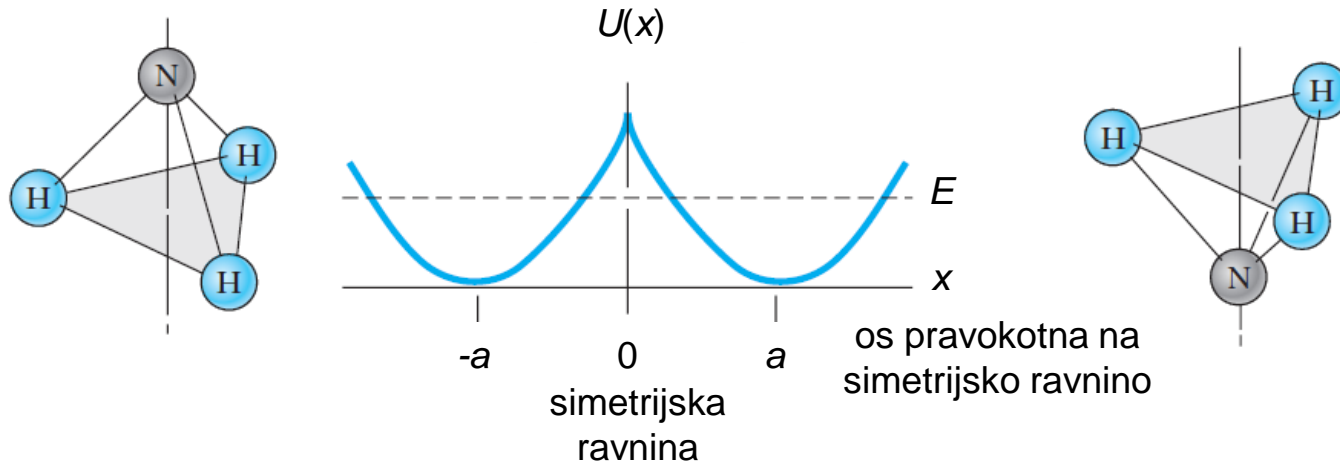

3. SEVANJE črnih lukenj:

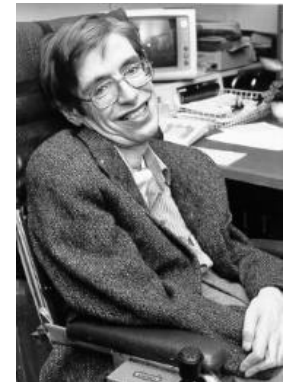
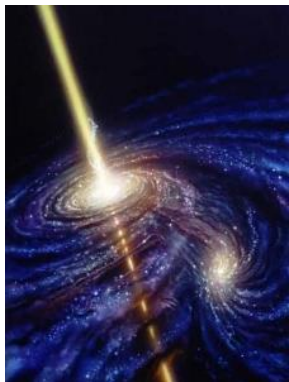

Stephen Hawking

Vir: internet; povzeto po Serway, Moses & Moyer, Modern Physics, Thomson Learning, 2005

5.6 Potencialna plast

4. Vrščični tunelski mikroskop (STM):

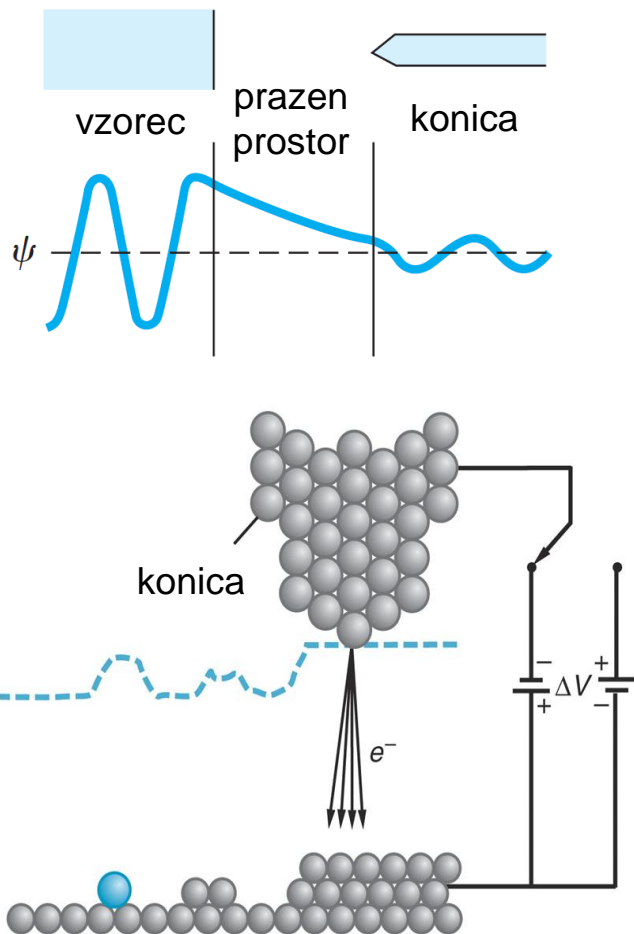

The Nobel Prize in Physics 1986



Ernst Ruska
Prize share: 1/2



Gerd Binnig
Prize share: 1/4



Heinrich Rohrer
Prize share: 1/4

The Nobel Prize in Physics 1986 was divided, one half awarded to Ernst Ruska *"for his fundamental work in electron optics, and for the design of the first electron microscope"*; the other half jointly to Gerd Binnig and Heinrich Rohrer *"for their design of the scanning tunneling microscope"*.



STM (IJS)

Vir: internet; povzeto po Serway, Moses & Moyer, Modern Physics, Thomson Learning, 2005; Tipler & Llewellyn, Modern Physics, W. H. Freeman and Company, 2012



MODERNA FIZIKA

Kvantna mehanika 4 Gibanje v 3D

6.1 Centralne sile

➤ Verjetnost:

$$P dV = |\Psi(\vec{r}, t)|^2 dV$$

➤ Stacionarna stanja:

$$\Psi(\vec{r}, t) = \psi(\vec{r}) e^{iEt/\hbar} = \psi(\vec{r}) e^{i\omega t}$$

➤ Hamiltonka:

$$\hat{W}_{kin} = -\frac{\hbar^2}{2m} \left(\frac{\partial^2}{\partial x^2} + \frac{\partial^2}{\partial y^2} + \frac{\partial^2}{\partial z^2} \right) = -\frac{\hbar^2}{2m} \nabla^2$$

$$-\frac{\hbar^2}{2m} \nabla^2 \psi(\vec{r}) + U(\vec{r}) \psi(\vec{r}) = E \psi(\vec{r})$$

➤ Krogelne koordinate: $\vec{r} = r(\sin \theta \cos \varphi, \sin \theta \sin \varphi, \cos \theta)$

$$dV = r^2 dr \sin \theta d\theta d\varphi$$

$$\nabla^2 = \frac{\partial^2}{\partial r^2} + \frac{2}{r} \frac{\partial}{\partial r} + \frac{1}{r^2} \frac{\partial^2}{\partial \theta^2} + \frac{1}{r^2 \tan \theta} \frac{\partial}{\partial \theta} + \frac{1}{r^2 \sin^2 \theta} \frac{\partial^2}{\partial \varphi^2}$$

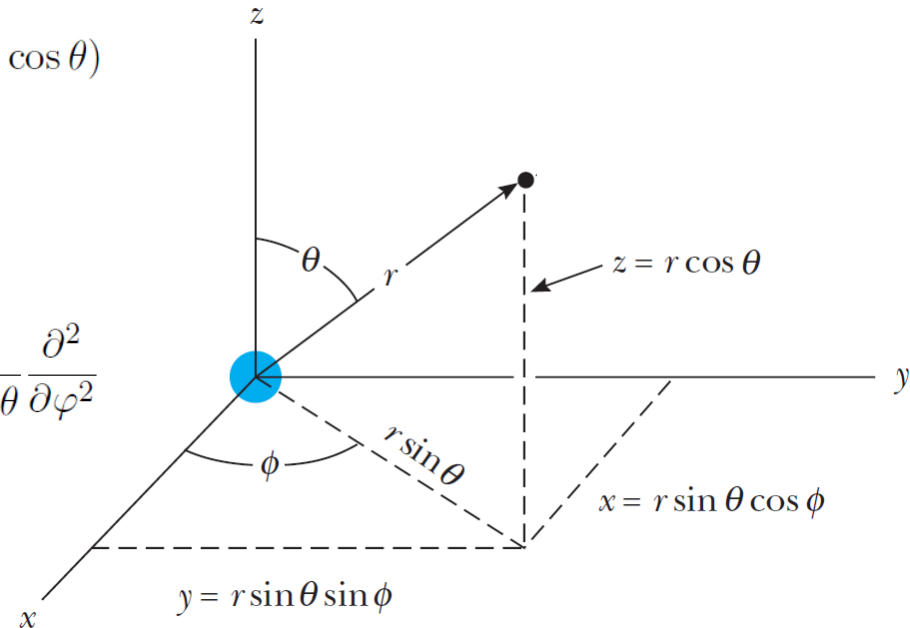

Vir: povzeto po Serway, Moses & Moyer, Modern Physics, Thomson Learning, 2005

6.1 Centralne sile

- Separacija spremenljivk:

$$\psi(r) = R(r)\Theta(\theta)\Phi(\varphi)$$

- Azimutni del valovne funkcije: **magnetno kvantno število** m

$$\frac{d^2\Phi(\varphi)}{d\varphi^2} = -m^2\Phi(\varphi) \quad \Rightarrow \quad \Phi(\varphi) = e^{im\varphi}$$

- Polarni del valovne funkcije: **orbitalno kvantno število** l

$$-\frac{d^2\Theta(\theta)}{d\theta^2} - \frac{1}{\tan\theta} \frac{d\Theta(\theta)}{d\theta} + \frac{m^2}{\sin^2\theta} \Theta(\theta) = l(l+1)\Theta(\theta)$$

$$\Rightarrow \Theta(\theta) = P_l^m(\theta)$$

$$l = 0, 1, 2, \dots$$

$$m = -l, -l+1, \dots, l-1, l$$

Pridruženi Legendrovi polinomi $P_l^m(\theta)$

$$P_0^0 = 1$$

$$P_1^0 = 2 \cos \theta$$

$$P_1^1 = \sin \theta$$

$$P_2^0 = 4(3 \cos^2 \theta - 1)$$

$$P_2^1 = 4 \sin \theta \cos \theta$$

$$P_2^2 = \sin^2 \theta$$

6.1 Centralne sile

➤ Kotni del valovne funkcije: $\Theta(\theta)\Phi(\varphi) = Y_l^m(\theta, \phi) = A_m P_l^m(\theta) e^{im\varphi}$

Krogelne funkcije $Y_l^m(\theta, \phi)$

$$|Y_0^0(\theta, \varphi)|^2$$



$$Y_0^0 = \frac{1}{2\sqrt{\pi}}$$

$$Y_1^0 = \frac{1}{2} \sqrt{\frac{3}{\pi}} \cdot \cos \theta$$

$$|Y_1^0(\theta, \varphi)|^2 \quad |Y_1^1(\theta, \varphi)|^2$$



$$Y_1^{\pm 1} = \mp \frac{1}{2} \sqrt{\frac{3}{2\pi}} \cdot \sin \theta \cdot e^{\pm i\phi}$$

$$Y_2^0 = \frac{1}{4} \sqrt{\frac{5}{\pi}} \cdot (3 \cos^2 \theta - 1)$$

$$|Y_2^0(\theta, \varphi)|^2 \quad |Y_2^1(\theta, \varphi)|^2 \quad |Y_2^2(\theta, \varphi)|^2$$



$$Y_2^{\pm 1} = \mp \frac{1}{2} \sqrt{\frac{15}{2\pi}} \cdot \sin \theta \cdot \cos \theta \cdot e^{\pm i\phi}$$

$$Y_2^{\pm 2} = \frac{1}{4} \sqrt{\frac{15}{2\pi}} \cdot \sin^2 \theta \cdot e^{\pm 2i\phi}$$

➤ Radialni del valovne funkcije:

$$-\frac{\hbar^2}{2m} \left(\frac{\partial^2 R(r)}{\partial r^2} + \frac{2}{r} \frac{\partial R(r)}{\partial r} \right) + \frac{\hbar^2 l(l+1)}{2mr^2} R(r) + U(r)R(r) = ER(r)$$

6.2 Kvantni rotator

- Rotacijska energija:

$$-\frac{\hbar^2}{2m} \left(\frac{\partial^2 R(r)}{\partial r^2} + \frac{2}{r} \frac{\partial R(r)}{\partial r} \right) + \frac{\hbar^2 l(l+1)}{2mr^2} R(r) + U(r)R(r) = ER(r)$$

- Vrtilna količina: $\hat{L}^2 Y_l^m(\theta, \phi) = l(l+1)\hbar^2 Y_l^m(\theta, \phi)$
 $\hat{L}^z Y_l^m(\theta, \phi) = m\hbar Y_l^m(\theta, \phi)$

$$\hat{W}_{rot} = \frac{\hat{L}^2}{2J}$$

$$\langle W_{rot} \rangle = \frac{\hbar^2 l(l+1)}{2J}$$

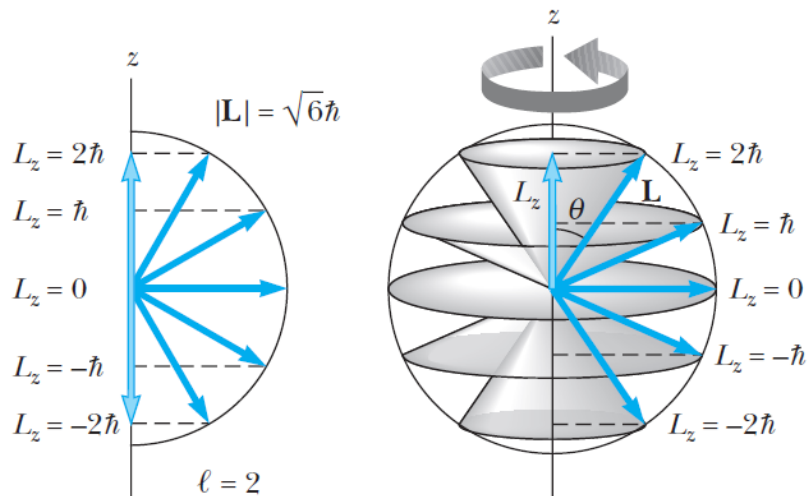
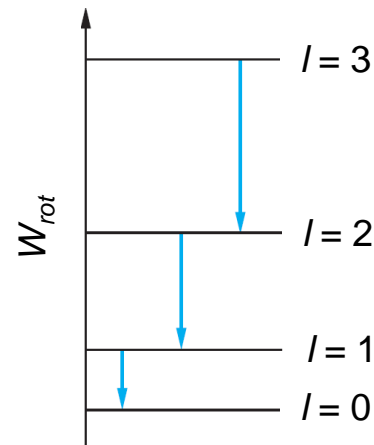

- Vrtenje po sferi: $r = \text{konst.}$ $\Theta(\theta)\Phi(\varphi) = Y_l^m(\theta, \phi) = A_m P_l^m(\theta) e^{im\varphi}$

$$\int_{\Omega} Y_l^{m*}(\theta, \phi) Y_{l'}^{m'}(\theta, \phi) \sin \theta d\theta d\varphi = \delta_{l,l'} \delta_{m,m'}$$

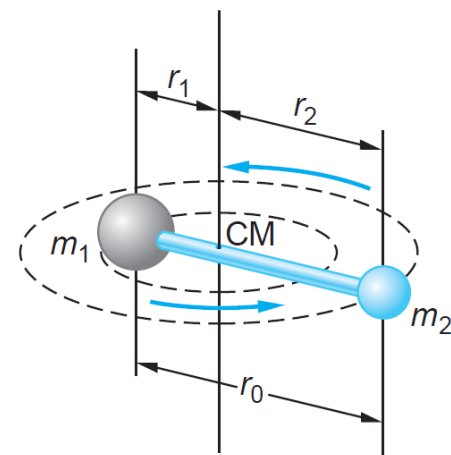

Vir: povzeto po Serway, Moses & Moyer, Modern Physics, Thomson Learning, 2005; Tipler & Llewellyn, Modern Physics, W. H. Freeman and Company, 2012

6.3 Atom vodika in njemu podobni atomi

➤ Elektrostatski potencial:

$$U(r) = -\frac{Ze_0^2}{4\pi\epsilon_0 r}$$

➤ Radialna valovna enačba: $-\frac{\hbar^2}{2m} \left(\frac{\partial^2 R(r)}{\partial r^2} + \frac{2}{r} \frac{\partial R(r)}{\partial r} \right) + \frac{\hbar^2 l(l+1)}{2mr^2} R(r) + -\frac{Ze_0^2}{4\pi\epsilon_0 r} R(r) = ER(r)$

➤ Valovne funkcije: $\Psi(r, \theta, \varphi, t) = \psi_{n,l,m}(r, \theta, \varphi) e^{-iEt/\hbar} = R_{n,l}(r) Y_l^m(\theta, \varphi) e^{-iEt/\hbar}$

➤ Lastne energije: $E_n = -\frac{1}{2} \frac{e_0^2}{4\pi\epsilon_0 r_B} \frac{Z^2}{n^2} = -E_0 \frac{Z^2}{n^2}$

$$E_0 = \frac{1}{2} \frac{e_0^2}{4\pi\epsilon_0 r_B} = 13,6 \text{ eV} \quad r_B = \frac{4\pi\epsilon_0 \hbar^2}{e_0^2 m_e} = \frac{\hbar^2 c^2}{\alpha m_e c^2}$$

➤ Kvantna števila:

1. glavno kvantno število (energija)

$$n \in \mathbb{N}$$

2. orbitalno kvantno število (vrtilna količina)

$$l = 0, 1, \dots, n - 1$$

3. magnetno kvantno število (projekcija vrtilne količine)

$$m = -l, -l + 1, \dots, l - 1, l$$

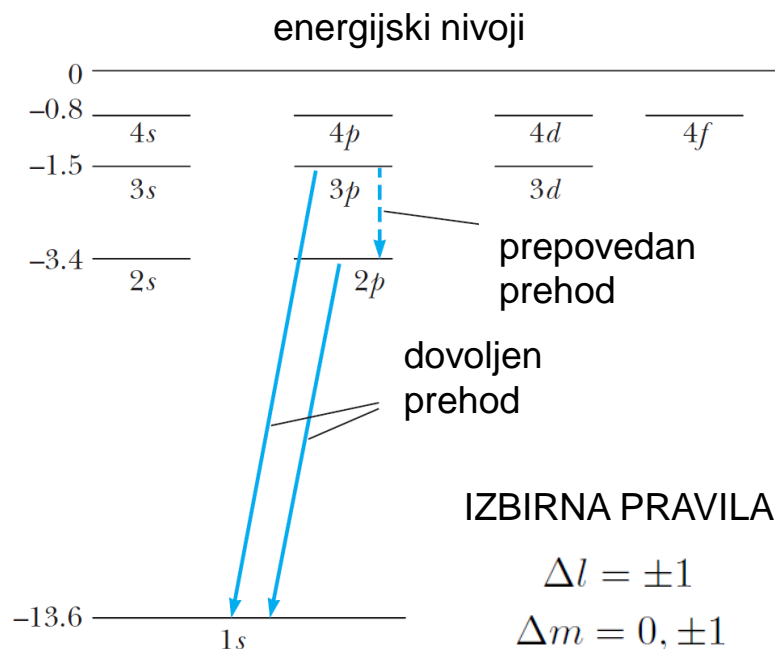

Vir: povzeto po Serway, Moses & Moyer, Modern Physics, Thomson Learning, 2005

6.3 Atom vodika in njemu podobni atomi

➤ Degeneracija:

$$d = n + 2 \times (n - 1) + 2 \times (n - 2) + \dots + 2 \times 1 = n^2$$

➤ Radialne valovne funkcije: $R_{n,l}(r)$

n	ℓ	$R_{n\ell}(r)$
1	0	$\left(\frac{Z}{a_0}\right)^{3/2} 2e^{-Zr/a_0}$
2	0	$\left(\frac{Z}{2a_0}\right)^{3/2} \left(2 - \frac{Zr}{a_0}\right) e^{-Zr/2a_0}$
2	1	$\left(\frac{Z}{2a_0}\right)^{3/2} \frac{Zr}{\sqrt{3}a_0} e^{-Zr/2a_0}$
3	0	$\left(\frac{Z}{3a_0}\right)^{3/2} 2 \left[1 - \frac{2Zr}{3a_0} + \frac{2}{27} \left(\frac{Zr}{a_0}\right)^2\right] e^{-Zr/3a_0}$
3	1	$\left(\frac{Z}{3a_0}\right)^{3/2} \frac{4\sqrt{2}}{3} \frac{Zr}{a_0} \left(1 - \frac{Zr}{6a_0}\right) e^{-Zr/3a_0}$
3	2	$\left(\frac{Z}{3a_0}\right)^{3/2} \frac{2\sqrt{2}}{27\sqrt{5}} \left(\frac{Zr}{a_0}\right)^2 e^{-Zr/3a_0}$

➤ Število vozlov:

$$n_v = n - l - 1$$

Vir: povzeto po Serway, Moses & Moyer, Modern Physics, Thomson Learning, 2005

➤ Radialna verjetnostna gostota:

$$\frac{a_0}{Z^3} \cdot P(r) \uparrow \quad P(r)dr = \int_0^\pi \sin\theta d\theta \cdot \int_0^{2\pi} d\varphi |\psi_{n,l,m}(r,\theta,\varphi)|^2 r^2 dr$$

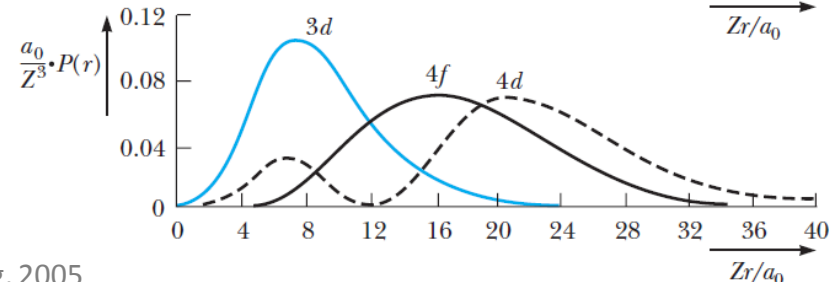
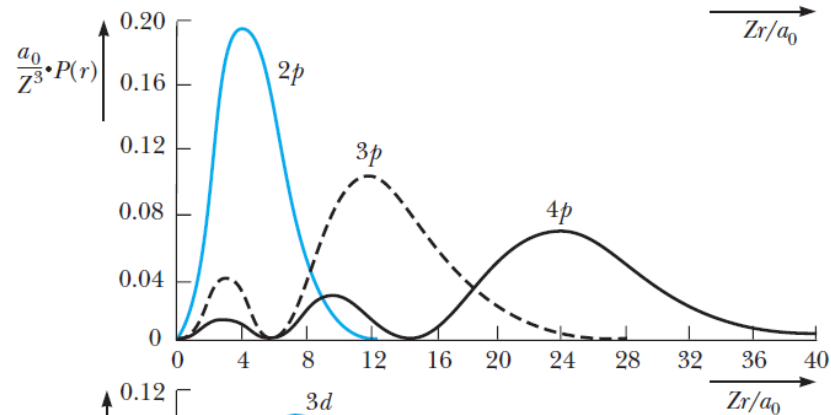
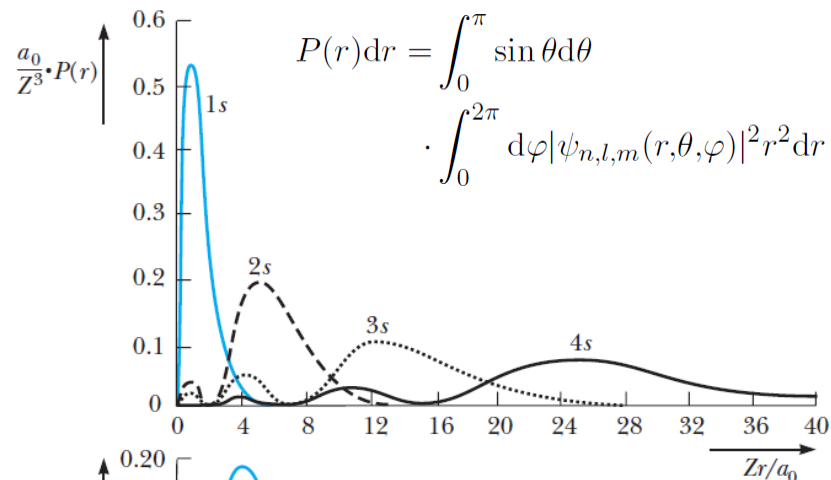

6.3 Atom vodika in njemu podobni atomi

➤ Lastne valovne funkcije:

$l = 0$

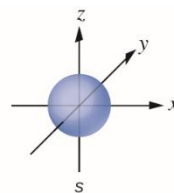

$l = 1$

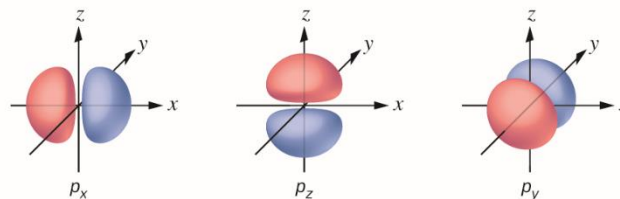

$l = 2$

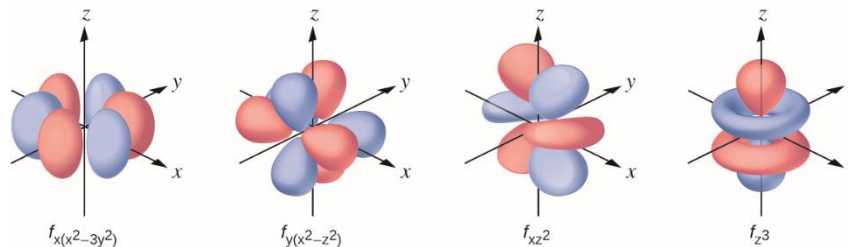
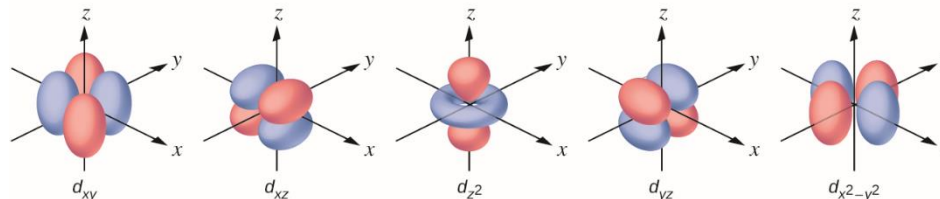

$l = 3$

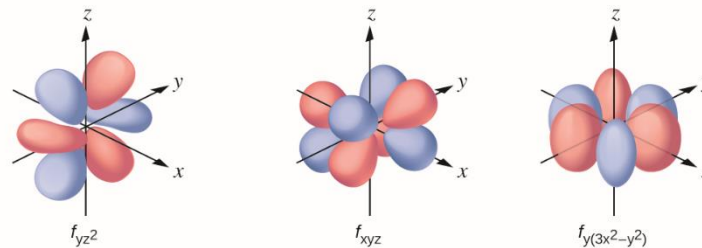

SIMULACIJA

Vir: internet



6.4 Atomski magnetizem

➤ Magnetni moment atoma:

$$\vec{\mu} = -\frac{e_0}{2m_e} \vec{L} = -\frac{\mu_B}{\hbar} \vec{L}$$

$$\mu_z = -\frac{\mu_B}{\hbar} L_z$$

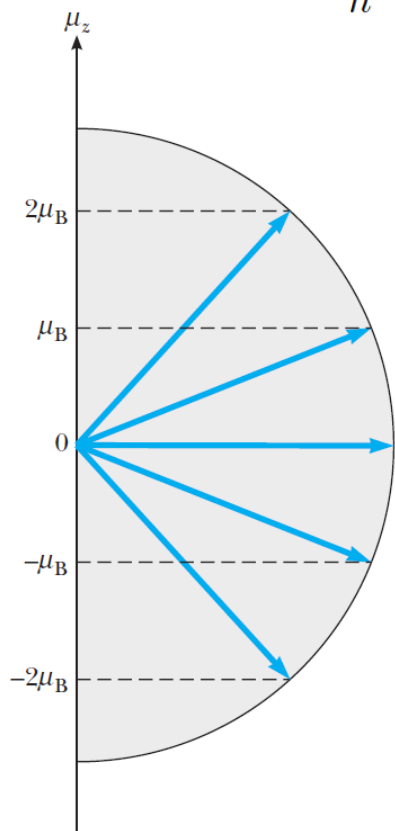

$\ell = 2$

$$\begin{aligned} \mu &= \sqrt{\ell(\ell+1)} \mu_B \\ &= \sqrt{6} \mu_B \end{aligned}$$

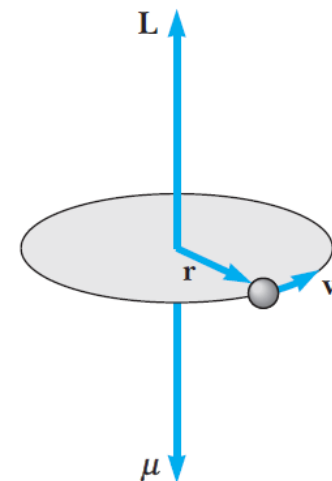
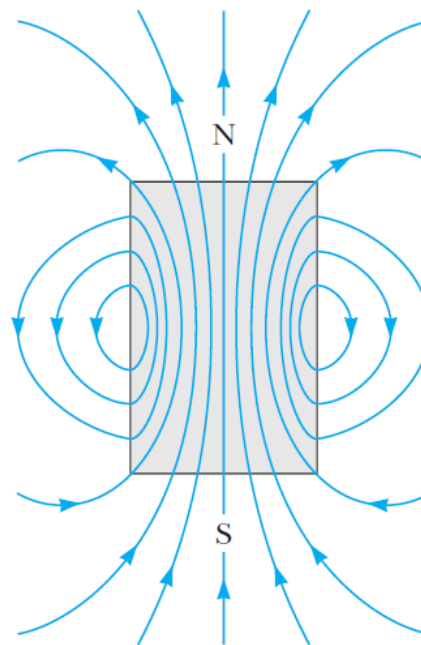
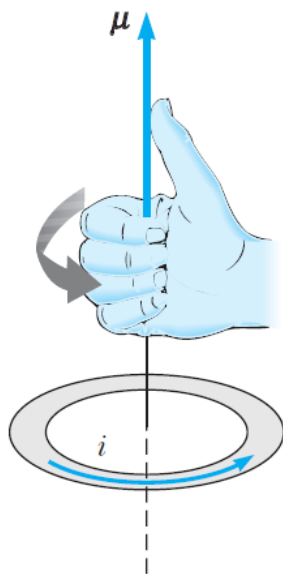

➤ Bohrov magneton:

$$\mu_B = \frac{e_0 \hbar}{2m_e} = 9,27 \times 10^{-24} \text{ Am}^2$$

➤ Kvantizacija momenta:

$$\mu_z = -\mu_B m$$

Vir: povzeto po Serway, Moses & Moyer, Modern Physics, Thomson Learning, 2005

6.4 Atomski magnetizem

➤ Zunanje magnetno polje: $E_m = -\vec{\mu} \cdot \vec{B} = \mu_B B m = \hbar \omega_L m$

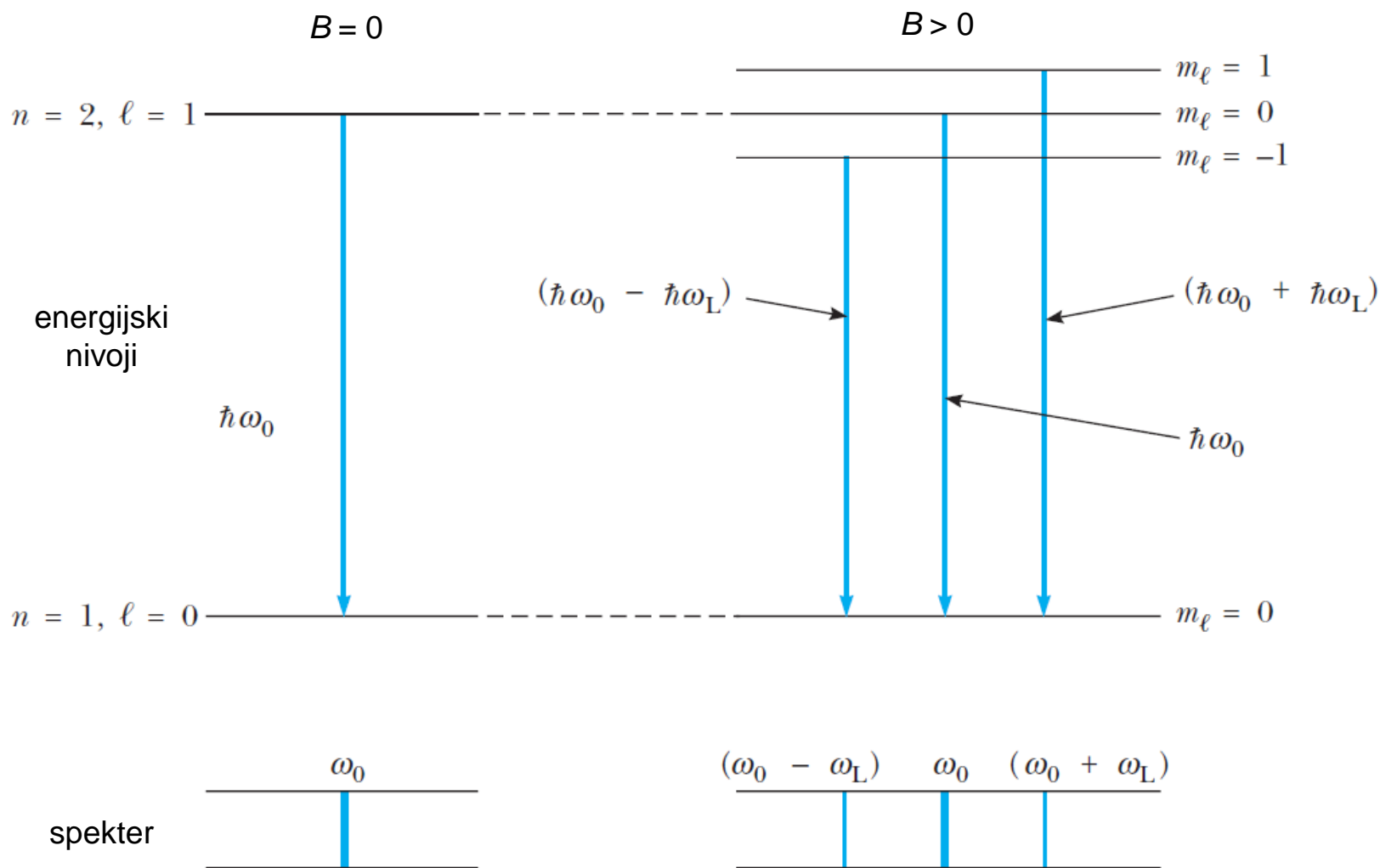

Vir: povzeto po Serway, Moses & Moyer, Modern Physics, Thomson Learning, 2005

6.5 Spin elektrona

➤ Stern-Gerlachov poskus:

$$\mu = \pm\mu_B = 2\mu_B m_s$$

$$s = \frac{1}{2} \quad m_s = \pm\frac{1}{2}$$

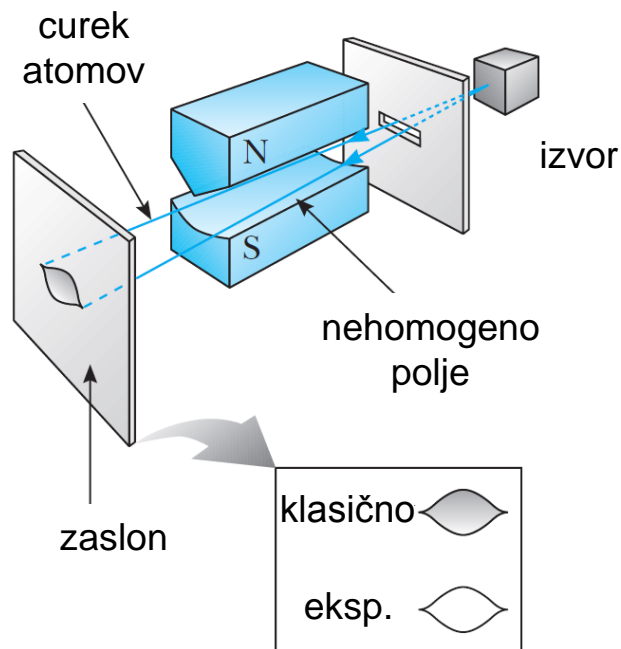

SIMULACIJA

Vir: internet; povzeto po Serway, Moses & Moyer, Modern Physics, Thomson Learning, 2005

The Nobel Prize in Physics 1943



Otto Stern
Prize share: 1/1

The Nobel Prize in Physics 1943 was awarded to Otto Stern "for his contribution to the development of the molecular ray method and his discovery of the magnetic moment of the proton".



6.5 Spin elektrona

- Spinska vrtilna količina:

$$|\vec{S}| = \sqrt{s(s+1)}\hbar = \frac{\sqrt{3}}{2}\hbar$$

$$|\vec{S}_z| = m_s\hbar = \pm\frac{1}{2}\hbar$$

- Spinski magnetni moment:

$$\vec{\mu}_s = -g\frac{\mu_B}{\hbar}\vec{S} \quad g = 2,0023$$

- Skupni magnetni moment:

$$\vec{\mu} = \vec{\mu}_o + \vec{\mu}_s = -\frac{\mu_B}{\hbar}(\vec{L} + g\vec{S})$$

- Lastno stanje (4 kvantna števila):

$$\psi_{n,l,m,m_s}(r, \theta, \varphi) = \psi_{n,l,m}(r, \theta, \varphi)\psi_s$$

$$\hat{S}^2 \psi_{n,l,m,m_s} = s(s+1)\hbar^2 \psi_{n,l,m,m_s}$$

$$\hat{S}^z \psi_{n,l,m,m_s} = m_s\hbar \psi_{n,l,m,m_s}$$

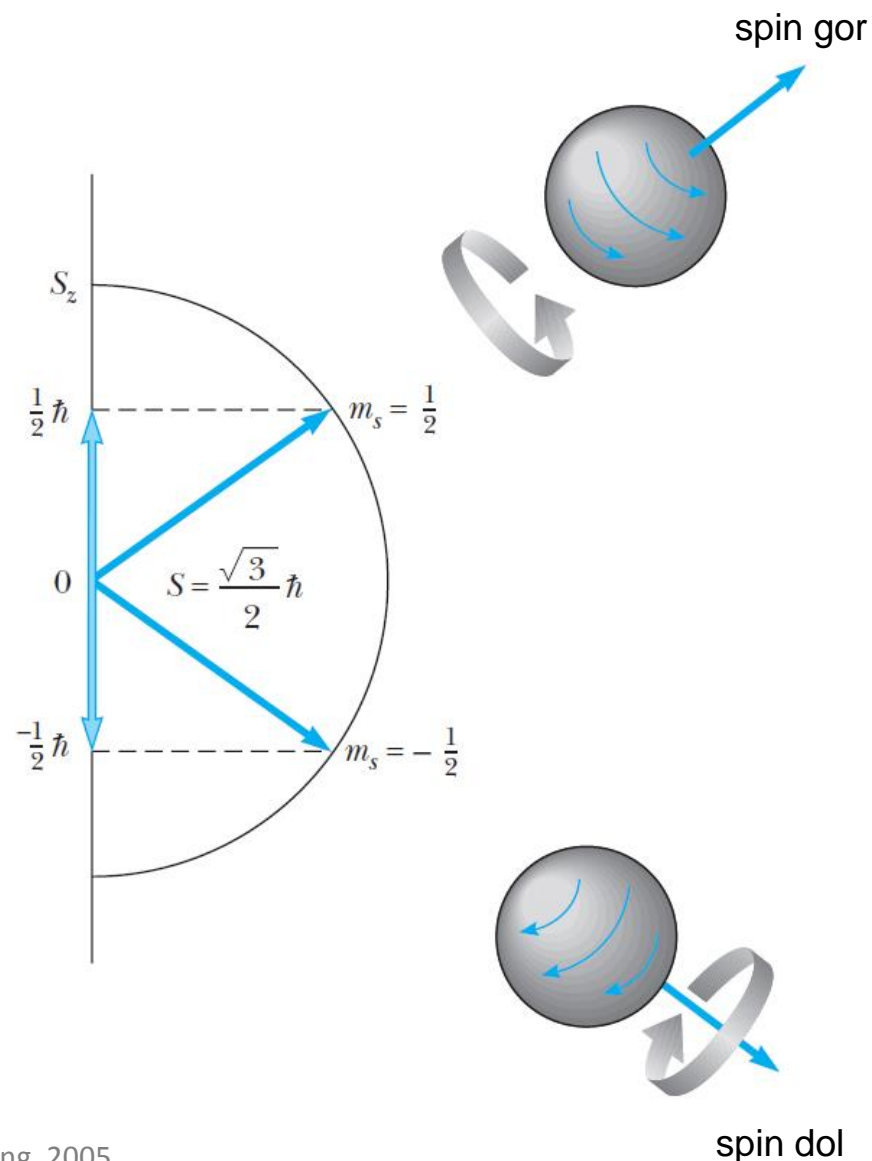

Vir: povzeto po Serway, Moses & Moyer, Modern Physics, Thomson Learning, 2005

spin dol

6.6 Sklopitev spinske in tirne vrtilne količine

- Notranji Zeemanov efekt:

$$E_{LS} = \frac{e^2}{8\pi\epsilon_0 m^2 c^2} \left\langle \frac{1}{r^3} \right\rangle \langle \vec{L} \cdot \vec{S} \rangle$$

$$= \frac{\lambda_{LS}}{\hbar^2} \langle \vec{L} \cdot \vec{S} \rangle$$

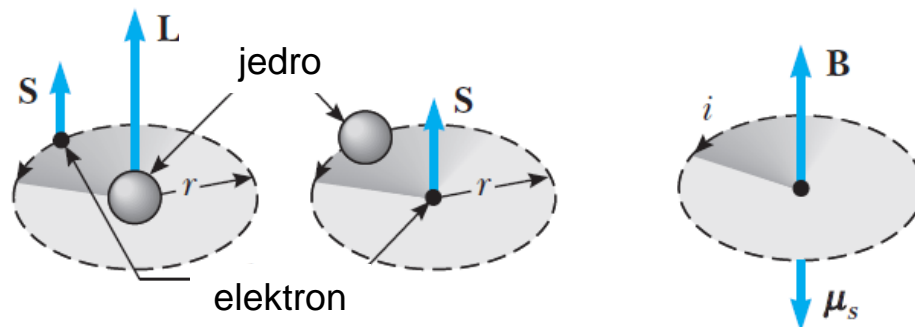

- Skupna vrtilna količina: $\vec{J} = \vec{L} + \vec{S}$

$$\hat{J}^2 \psi_{n,l,j,m_j} = j(j+1)\hbar^2 \psi_{n,l,j,m_j}$$

$$\hat{J}^z \psi_{n,l,j,m_j} = m_j \hbar \psi_{n,l,j,m_j}$$

- Novi kvantni števili:

$$|l - s| \leq j \leq l + s$$

$$m_j = -j, -j + 1, \dots, j$$

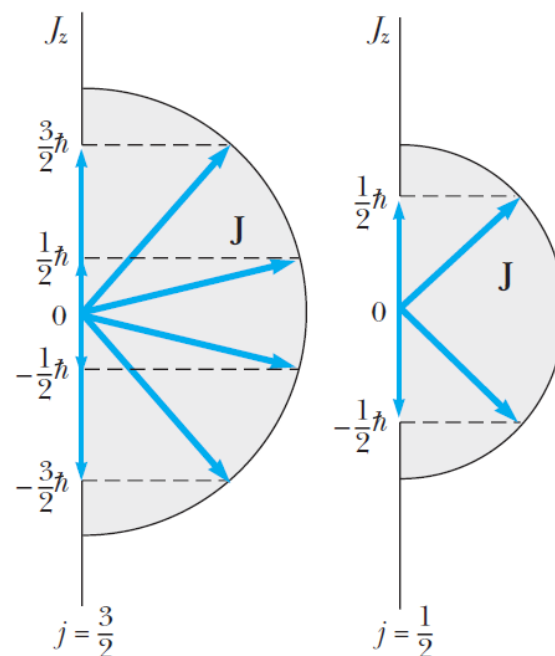
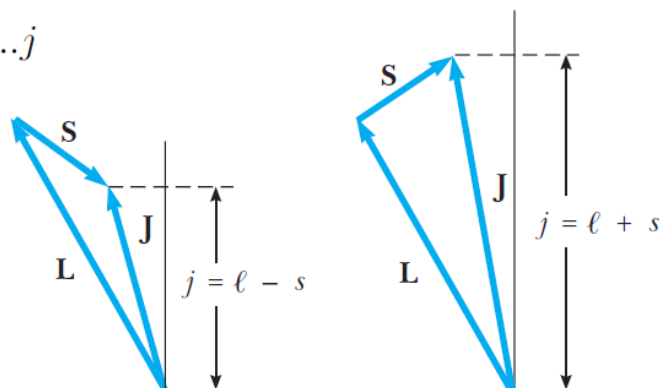

Vir: povzeto po Serway, Moses & Moyer, Modern Physics, Thomson Learning, 2005

6.6 Sklopitev spinske in tirne vrtilne količine

- Energijski razcep:

$$\langle \vec{L} \cdot \vec{S} \rangle = \frac{\langle J^2 \rangle - \langle L^2 \rangle - \langle S^2 \rangle}{2} = \frac{j(j+1) - l(l+1) - s(s+1)}{2} \hbar^2$$



2p:

$$\Delta E = \frac{3}{2} \lambda_{LS}$$

- Spektroskopske oznake: nL_j

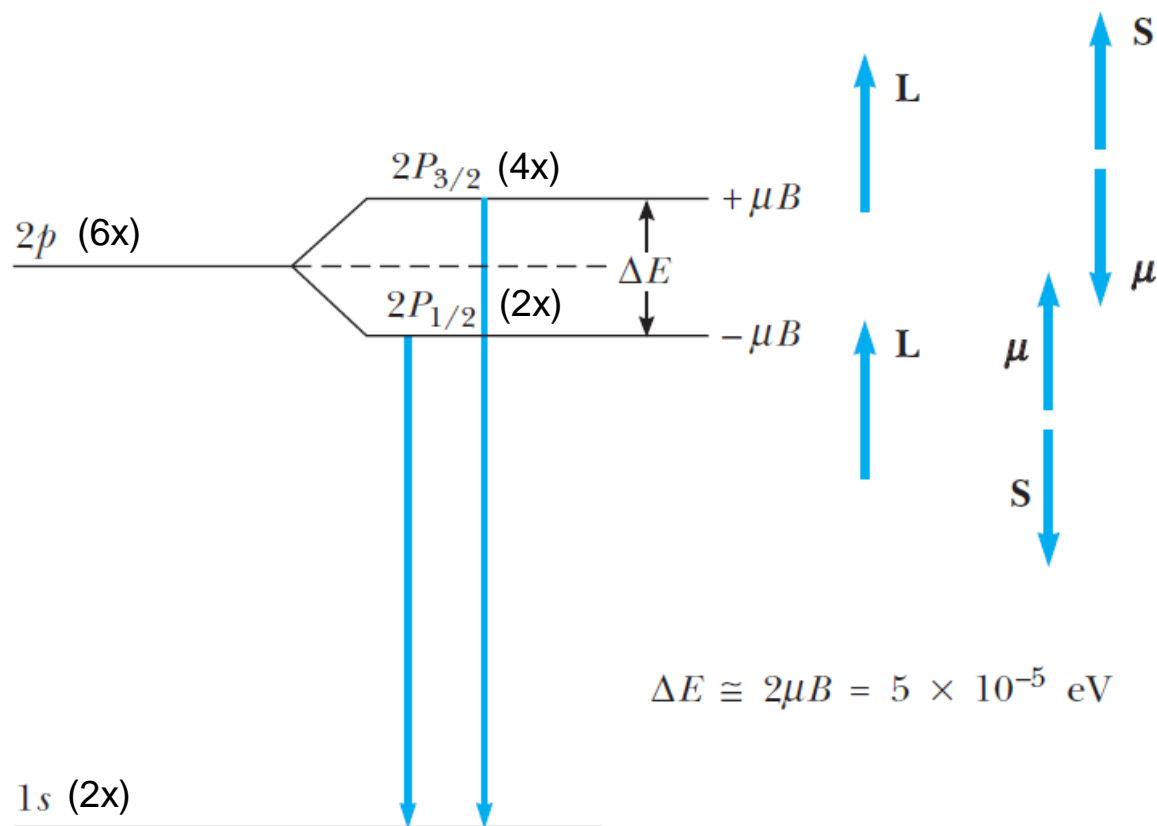

$$\Delta E \cong 2\mu B = 5 \times 10^{-5} \text{ eV}$$

- Notranje polje: $B_{int} \sim 1 \text{ T}$

Vir: povzeto po Serway, Moses & Moyer, Modern Physics, Thomson Learning, 2005

6.7 Zeemanov razcep

- Moment $\vec{\mu} = \vec{\mu}_o + \vec{\mu}_s = -\frac{\mu_B}{\hbar}(\vec{L} + g\vec{S})$
v zunanjem polju $\vec{B} \parallel \vec{c}$:

$$\hat{H}_z = \frac{\mu_B}{\hbar}(\hat{L}_z + g\hat{S}_z)B$$

1. Šibko polje: $B \ll B_{int} \sim 1 \text{ T}$



$$E_z = g_{lsj}\mu_B B m_j$$

$$g_{lsj} = \frac{3}{2} - \frac{l(l+1) - s(s+1)}{2j(j+1)}$$

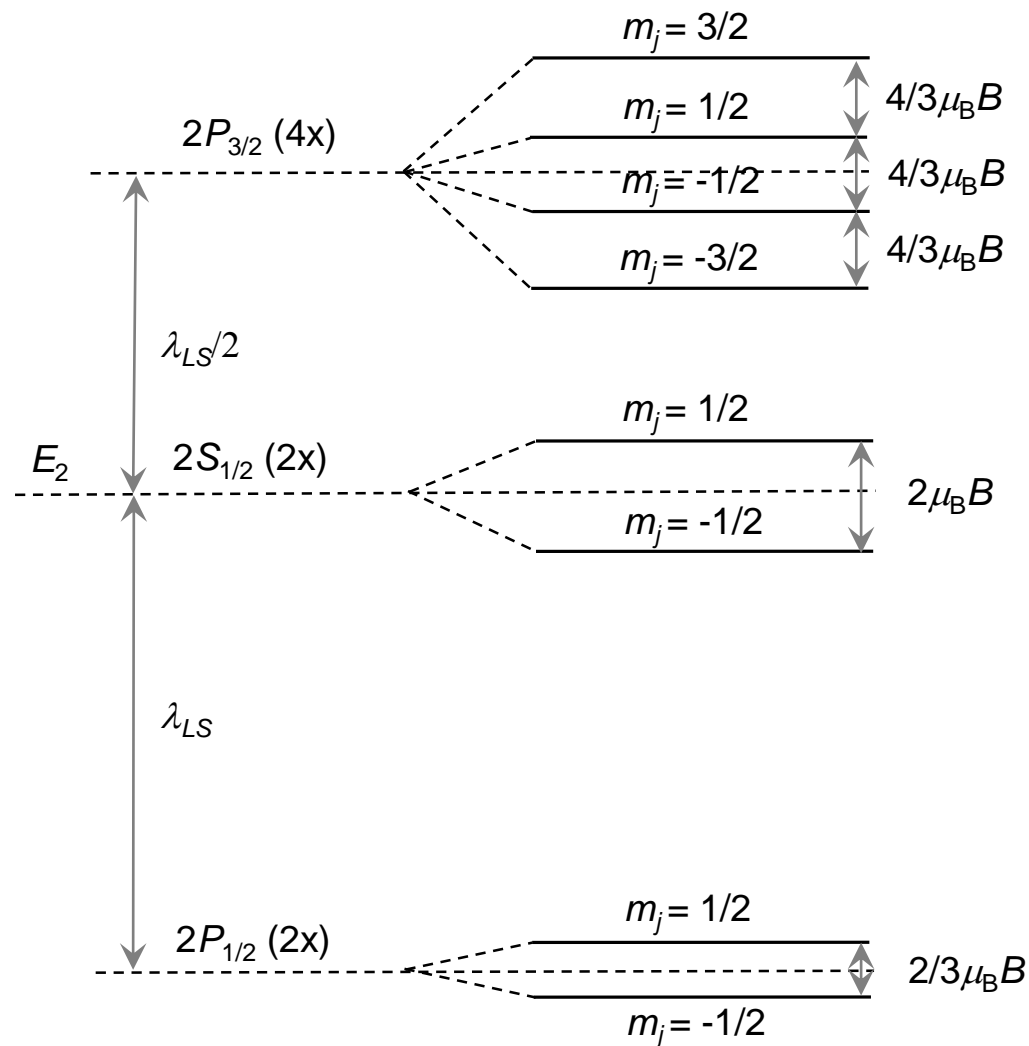

6.7 Zeemanov razcep

2. Močno polje: $B \gg B_{int} \sim 1 \text{ T}$ \longrightarrow $E_z = \mu_B B(m + gm_s)$

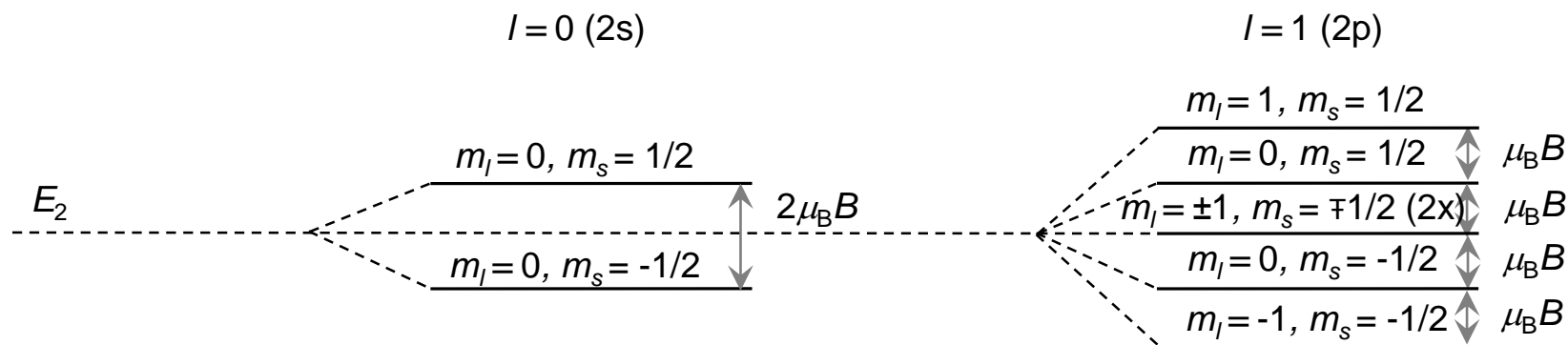

➤ Elektronska spinska resonanca:

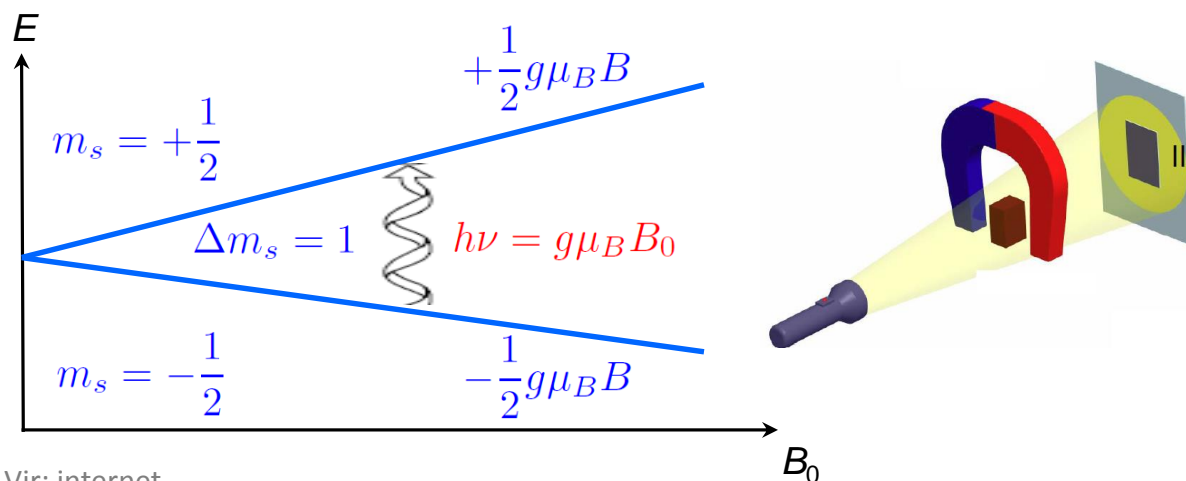

Vir: internet



ESR spektrometer (IJS)

6.8 Atomi z več elektroni

- Paulijevo izključitveno načelo: atomsko stanje (n, l, j, m_j) oz. (n, l, m, m_s) največ enkrat zasedeno!
- Neločljivost identičnih delcev v kvantni mehaniki (izmenjalna simetrija):

$$|\psi(\vec{r}_1, \vec{r}_2)|^2 = |\psi(\vec{r}_2, \vec{r}_1)|^2$$

BOZONI: $\psi(\vec{r}_1, \vec{r}_2) = \psi(\vec{r}_2, \vec{r}_1)$

FERMIONI: $\psi(\vec{r}_1, \vec{r}_2) = -\psi(\vec{r}_2, \vec{r}_1)$

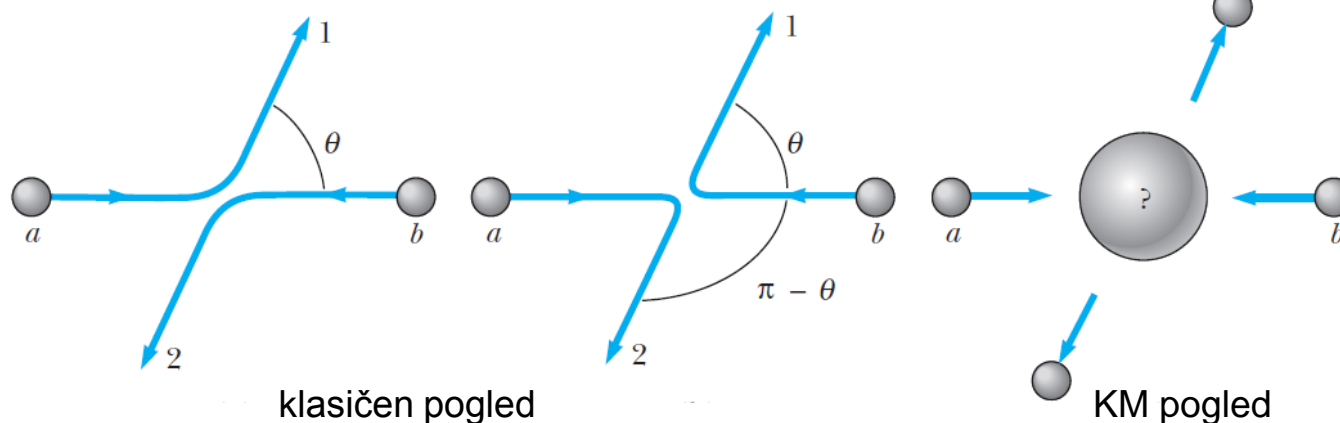

The Nobel Prize in Physics 1945

































Wolfgang Pauli
Prize share: 1/1

The Nobel Prize in Physics 1945 was awarded to Wolfgang Pauli "for the discovery of the Exclusion Principle, also called the Pauli

6.8 Atomi z več elektroni

➤ Elektronska konfiguracija:

Atom	1s	2s	2p			Konfiguracija
Li						$1s^2 2s^1$
Be						$1s^2 2s^2$
B						$1s^2 2s^2 2p^1$
C						$1s^2 2s^2 2p^2$
N						$1s^2 2s^2 2p^3$
O						$1s^2 2s^2 2p^4$

Vir: povzeto po Serway, Moses & Moyer, Modern Physics, Thomson Learning, 2005



6.8 Atomi z več elektroni

➤ Periodni sistem elementov:

	1	2	3	4	5	6	7	8	9	10	11	12	13	14	15	16	17	18
1	H Vodik -1,1	He Helij	1 H Vodik 1,008															
2	Li Litij 1	Be Berilij 2																
3	Na Natrij 1	Mg Magnezij 2																
4	K Kalij 1	Ca Kalcij 2	Sc Skandij 3	Ti Titan 4	V Vanadij 5	Cr Krom 3,6	Mn Mangan 2,4,7	Fe Železo 2,3	Co Kobalt 2,3	Ni Nikelj 2	Cu Baker 2	Zn Cink 2	Ga Galij 3	Ge Germanij -4,2,4	As Arzen -3,3,5	Se Selen -2,2,4,6	Br Brom -1,1,3,5	Kr Kripton 2
5	Rb Rubidij 1	Sr Stroncij 2	Y Itrij 3	Zr Cirkonij 4	Nb Niobij 5	Mo Molibden 4,6	Tc Tehnecij 4,7	Ru Rutenij 3,4	Rh Rodij 3	Pd Paladij 2,4	Ag Srebro 1	Cd Kadmij 2	In Indij 3	Sn Kositler -4,2,4	Sb Antimon -3,3,5	Te Telur -2,2,4,6	I Jod -1,1,3,5,7	Xe Ksenon 2,4,6
6	Cs Cezij 1	Ba Barij 2	57-71	Hf Hafnij 4	Ta Tantal 5	W Volfram 4,6	Re Renij 4	Os Osmij 4	Ir Iridij 3,4	Pt Platina 2,4	Au Zlato 3	Hg Žvorožce 1,2	Tl Talij 1,3	Pb Svinec 2,4	Bi Bizmut 3	Po Polonij -2,2,4	At Astat -1,1	Rn Radon 2
7	Fr Francij 2	Ra Radij 2	89-103	Rf Raderfordij 4	Db Dubnij 5	Sg Siborgij 6	Bh Borij 7	Hs Hasij 8	Mt Majtnerij	Ds Darmštadij	Rg Roentgenij	Cn Kopernicij	Nh Nihonium	Fl Ununkvadrij	Mc Moscovium	Lv Ununheksij	Ts Tennessine	Og Oganesson

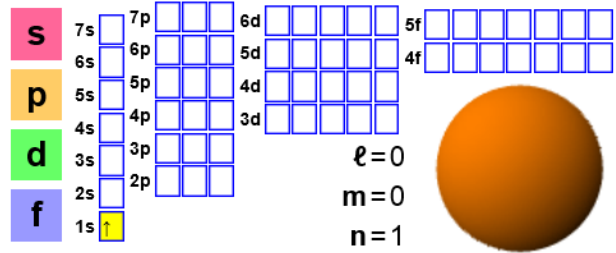

Najpogostejša oksidacijska stanja so pokazana pod elementom.

Periodni Sistem Design & Interface Copyright © 1997 Michael Dayah. Ptable.com Last updated 16. jun. 2017

57 La Lantan 3	58 Ce Cerij 3,4	59 Pr Prazeodim 3	60 Nd Neodim 3	61 Pm Prometij 3	62 Sm Samarij 3	63 Eu Evropij 2,3	64 Gd Gadolonij 3	65 Tb Terbij 3	66 Dy Disprozij 3	67 Ho Holmij 3	68 Er Erbij 3	69 Tm Tulij 3	70 Yb Iterbij 3	71 Lu Lutecij 3
89 Ac Aktinij 3	90 Th Torij 4	91 Pa Protaktinij 5	92 U Uran 6	93 Np Neptunij 5	94 Pu Plutonij 4	95 Am Americij 3	96 Cm Kirijski 3	97 Bk Berkelij 3	98 Cf Kalifornij 3	99 Es Ajnštajnski 3	100 Fm Fermij 3	101 Md Mendelevij 3	102 No Nobelij 2	103 Lr Lavrencij 3

SIMULACIJA

Vir: internet



MODERNA FIZIKA

Kvantna mehanika 5 Molekule

7.1 Povezovanje atomov v molekule in tipi vezi

➤ Molekulske vezi: izključitveno načelo in tuneliranje

➤ Molekulski potencial:

$$U(r) = -\frac{A}{r^n} + \frac{B}{r^m}$$

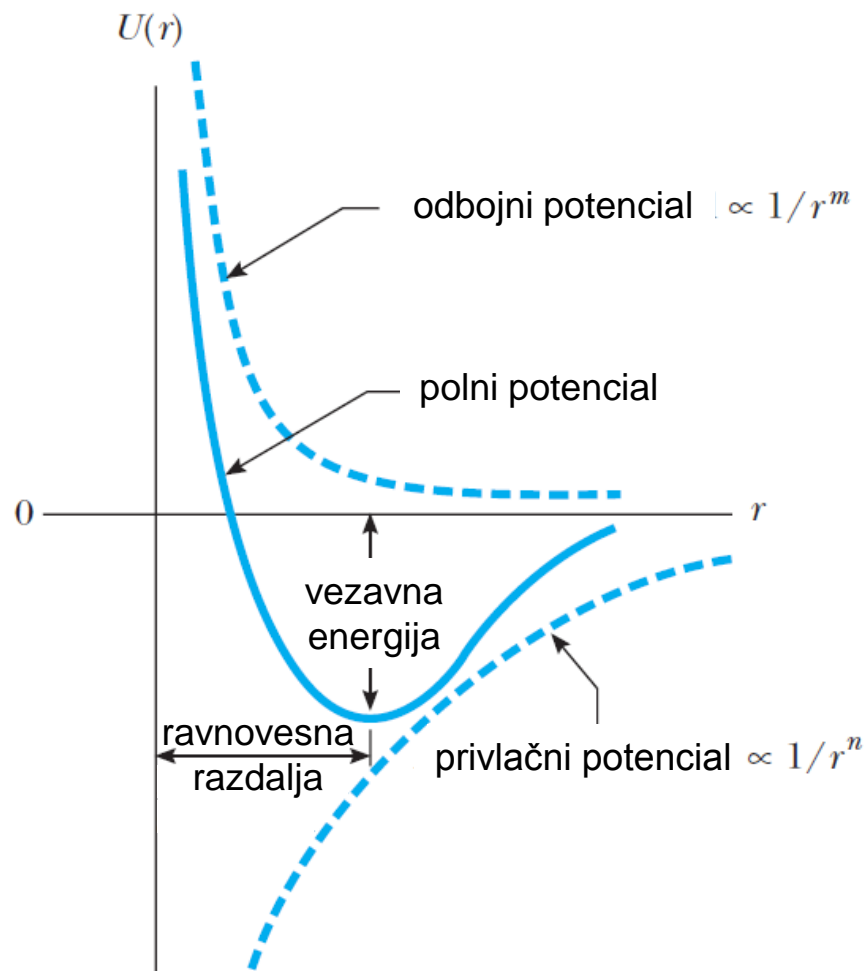

Vir: povzeto po Serway, Moses & Moyer, Modern Physics, Thomson Learning, 2005

7.1 Povezovanje atomov v molekule in tipi vezi

➤ Tipi molekulskih vezi

1. Ionska vez:

- ionizacijska energija
- elektronska afiniteta
- aktivacijska energija
- disociacijska energija

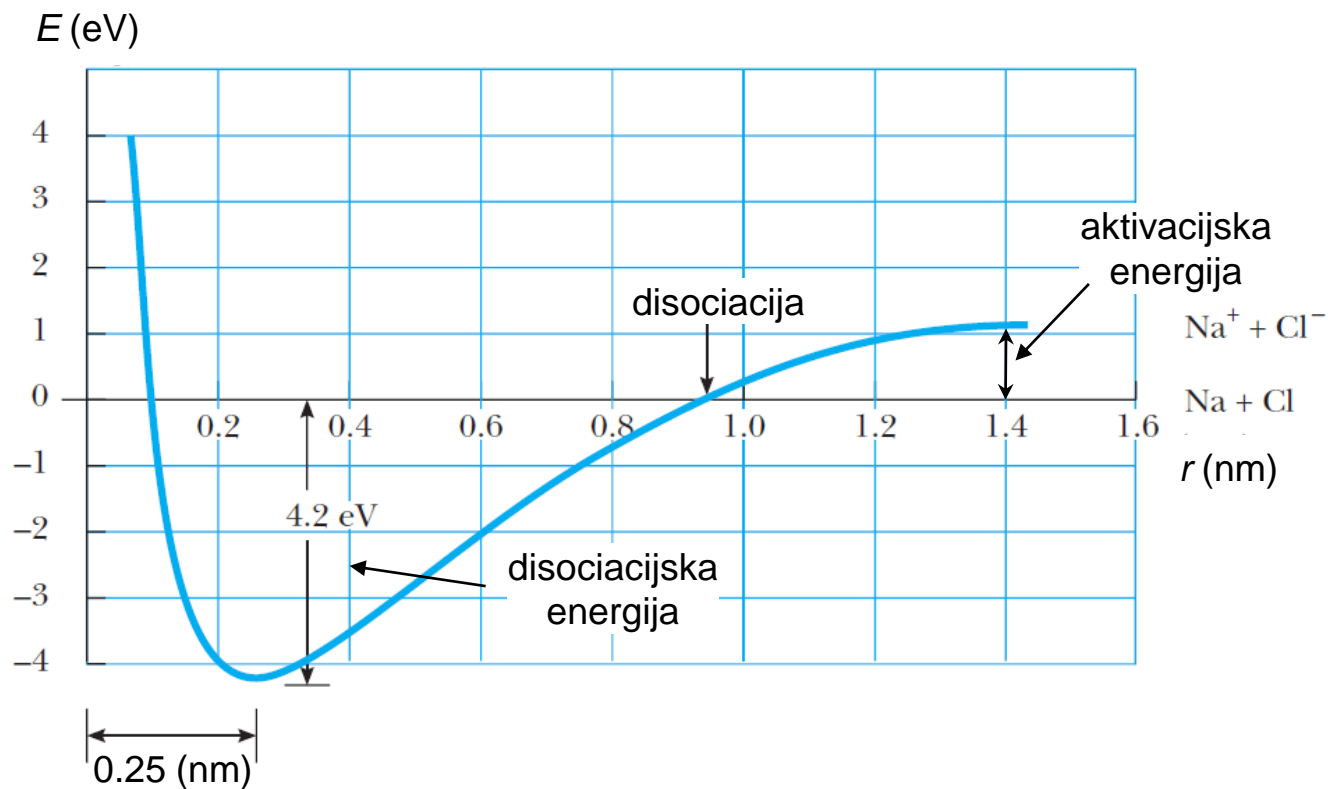

Vir: povzeto po Serway, Moses & Moyer, Modern Physics, Thomson Learning, 2005

7.1 Povezovanje atomov v molekule in tipi vezi

2. Kovalentna vez: molekulske orbitale

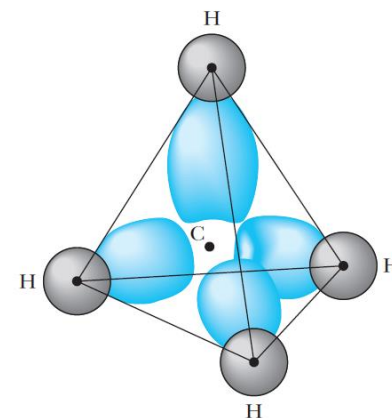
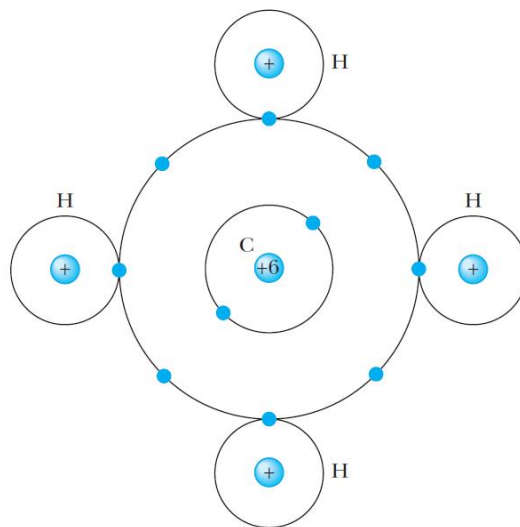
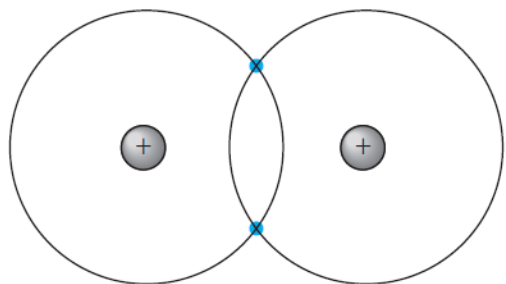

3. Van der Wallsova vez:

privlak



odboj



odboj

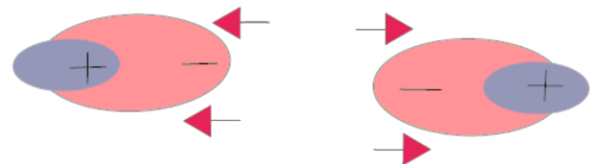

4. Vodikova vez:

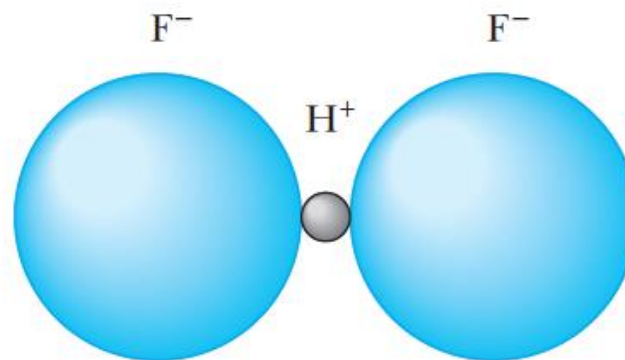

Vir: povzeto po Serway, Moses & Moyer, Modern Physics, Thomson Learning, 2005

7.2 Rotacijska in vibracijska vzbujena stanja molekul

➤ Rotacije molekul:

$$E_{rot}^l = \frac{\hbar^2}{2J} l(l+1)$$

$$J = m_r r^2$$

$$\frac{1}{m_r} = \frac{1}{m_1} + \frac{1}{m_2} \quad r = r_1 + r_2$$

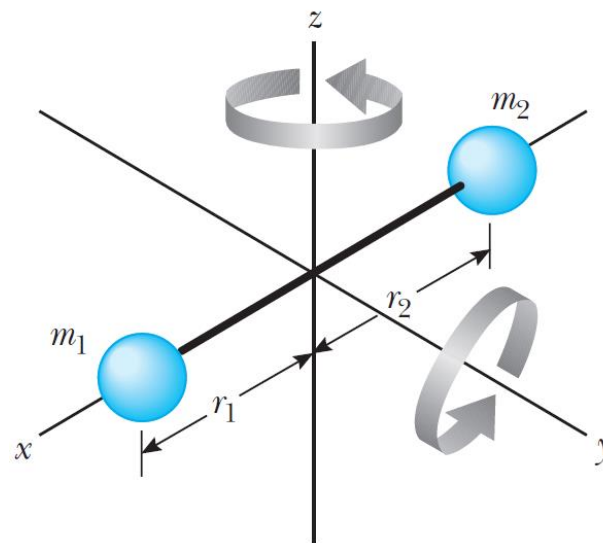

➤ Absorpcijski spekter: $\Delta l = \pm 1$

1. veja P: $l \rightarrow l-1$ $\Delta E_P^l = -\frac{\hbar^2}{J} l$

2. veja R: $l \rightarrow l+1$ $\Delta E_R^l = \frac{\hbar^2}{J} (l+1)$

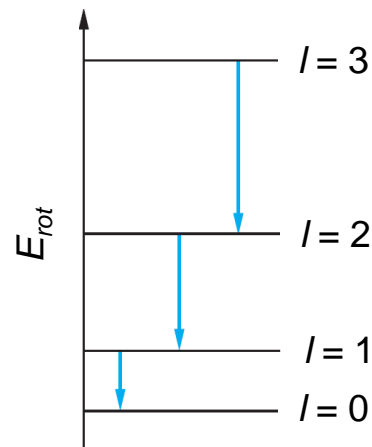
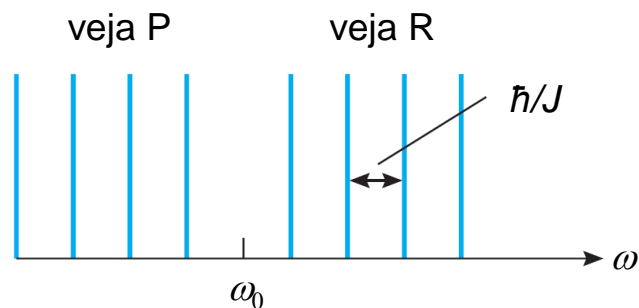

Vir: povzeto po Serway, Moses & Moyer, Modern Physics, Thomson Learning, 2005

7.2 Rotacijska in vibracijska vzbujena stanja molekul

- Vibracije molekul:

$$E_{vib}^n = \left(n + \frac{1}{2} \right) \hbar \omega$$

$$\omega = \sqrt{\frac{K}{m_r}} \quad K = \left. \frac{d^2 U(r)}{dr^2} \right|_{r=r_0}$$

- Absorpcijski spekter: $\Delta n = \pm 1$ $\Delta E_{vib} = \hbar \omega$

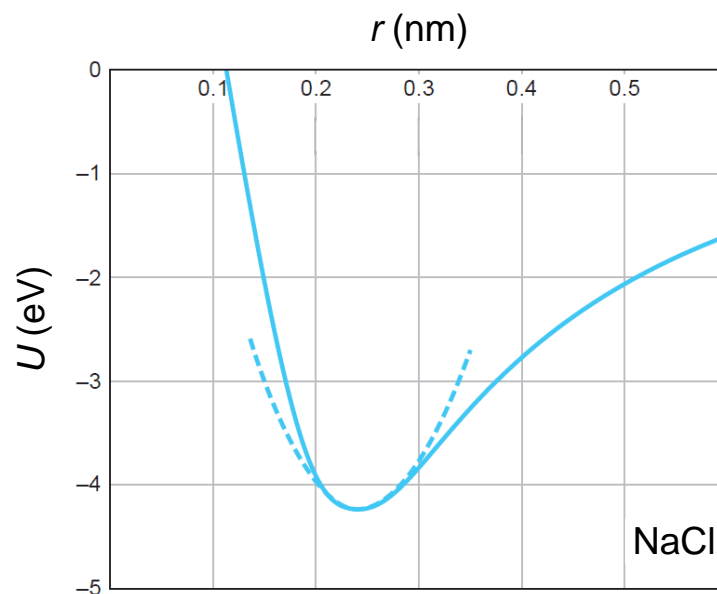
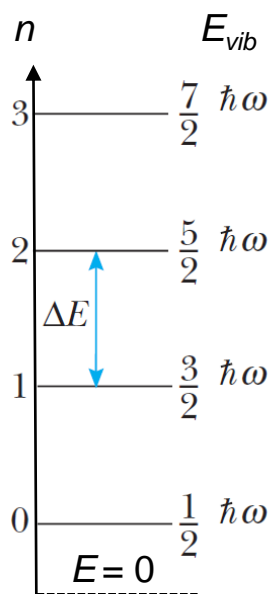
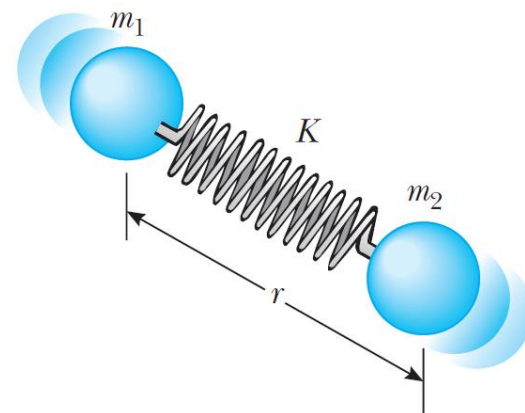

Vir: povzeto po Serway, Moses & Moyer, Modern Physics, Thomson Learning, 2005; Tipler & Llewellyn, Modern Physics, W. H. Freeman and Company, 2012

7.2 Rotacijska in vibracijska vzbujena stanja molekul

➤ Rotacijsko-vibracijski spekter:

$$E_{rot-vib}^{l,n} = \frac{\hbar^2}{2J} l(l+1) + \left(n + \frac{1}{2}\right) \hbar\omega$$

➤ Izbirna pravila za optične prehode:

$$\Delta l = \pm 1$$

$$\Delta n = \pm 1$$

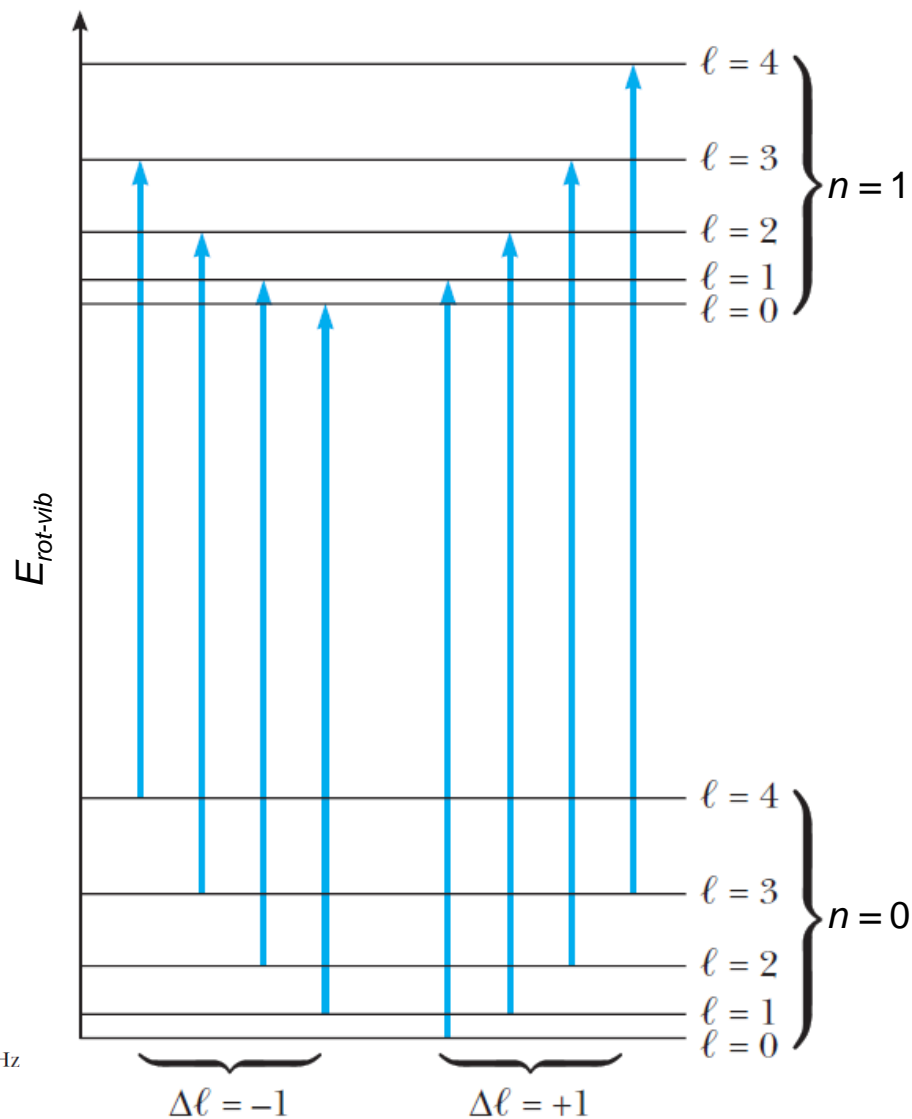
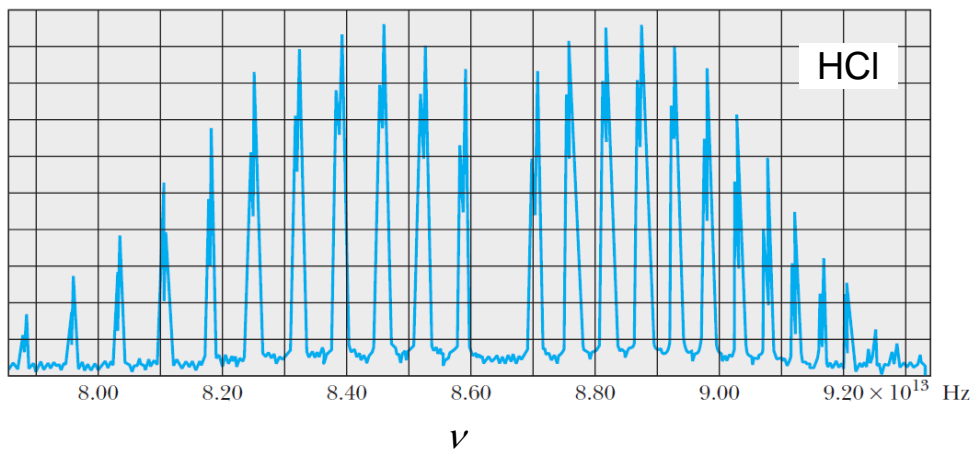

Vir: povzeto po Serway, Moses & Moyer, Modern Physics, Thomson Learning, 2005

7.3 Kvantnomehanski opis molekul

1. Molekula H_2^+ :

$$U(\vec{r}) = -\frac{e^2}{4\pi\epsilon_0|\vec{r}|} - \frac{e^2}{4\pi\epsilon_0|\vec{r} - \vec{R}|}$$

$$U_j(\vec{r}) = \frac{e^2}{4\pi\epsilon_0|\vec{R}|}$$

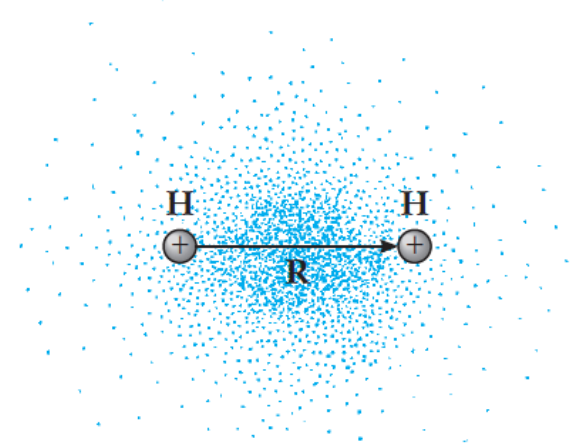

➤ Simetrična funkcija:

$$\psi_+(\vec{r}) = \psi_a(\vec{r}) + \psi_a(\vec{r} - \vec{R})$$

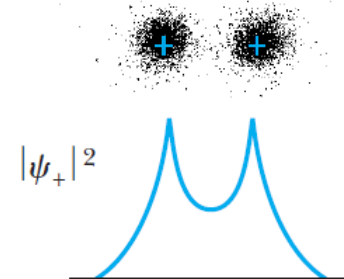

➤ Antisimetrična funkcija:

$$\psi_-(\vec{r}) = \psi_a(\vec{r}) - \psi_a(\vec{r} - \vec{R})$$

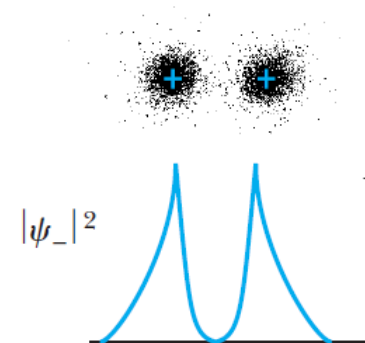
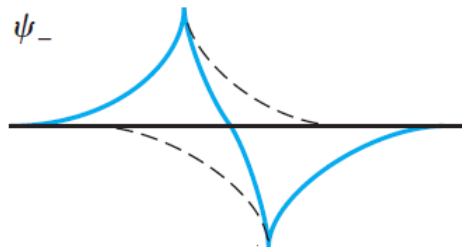

Vir: povzeto po Serway, Moses & Moyer, Modern Physics, Thomson Learning, 2005

7.3 Kvantnomehanski opis molekul

➤ Energija:

$$E_{\pm}(R) = -E_0 \left[1 + \frac{2}{1 \pm (1 + R/r_B + R^2/3r_B)e^{-R/r_B}} \times \left(\frac{r_B}{R} - \frac{r_B}{R} \left(1 + \frac{R}{r_B} \right) e^{-2R/r_B} \pm \left(1 + \frac{R}{r_B} \right) e^{-R/r_B} \right) \right]$$

$$E_j = E_0 \frac{2r_B}{R}$$

$$E_v = -2,7 \text{ eV}$$

$$R_0 = 0,106 \text{ nm}$$

2. Molekula H₂:

$$E_v = -4,5 \text{ eV}$$

$$R_0 = 0,074 \text{ nm}$$

SIMULACIJA

Vir: internet; povzeto po Tipler & Llevellyn, Modern Physics, W. H. Freeman and Company, 2012

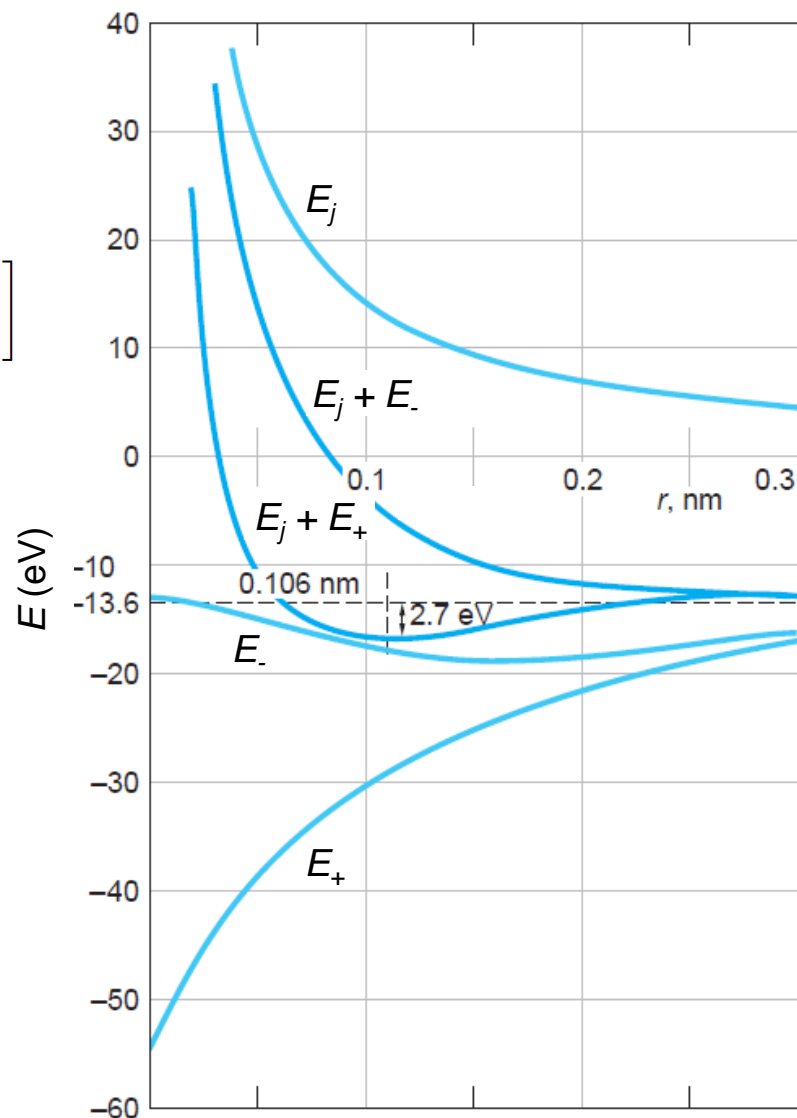



MODERNA FIZIKA

Statistična fizika

8.1 Maxwell-Boltzmannova porazdelitev

➤ Osnovne predpostavke:

1. razločljivi identični delci
2. ravnovesna porazdelitev
3. majhna gostota/visoka temperatura

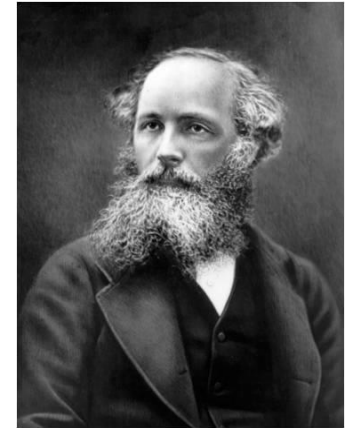

J. C. Maxwell

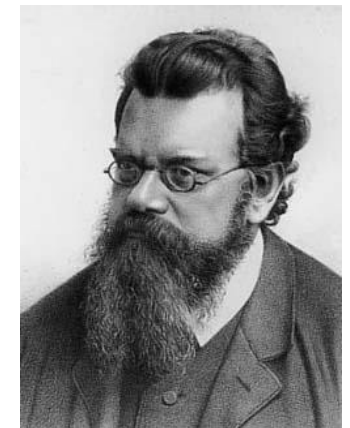

L. Boltzmann



8.1 Maxwell-Boltzmannova porazdelitev

➤ *Primer: 6 delcev s skupno energijo 8E*

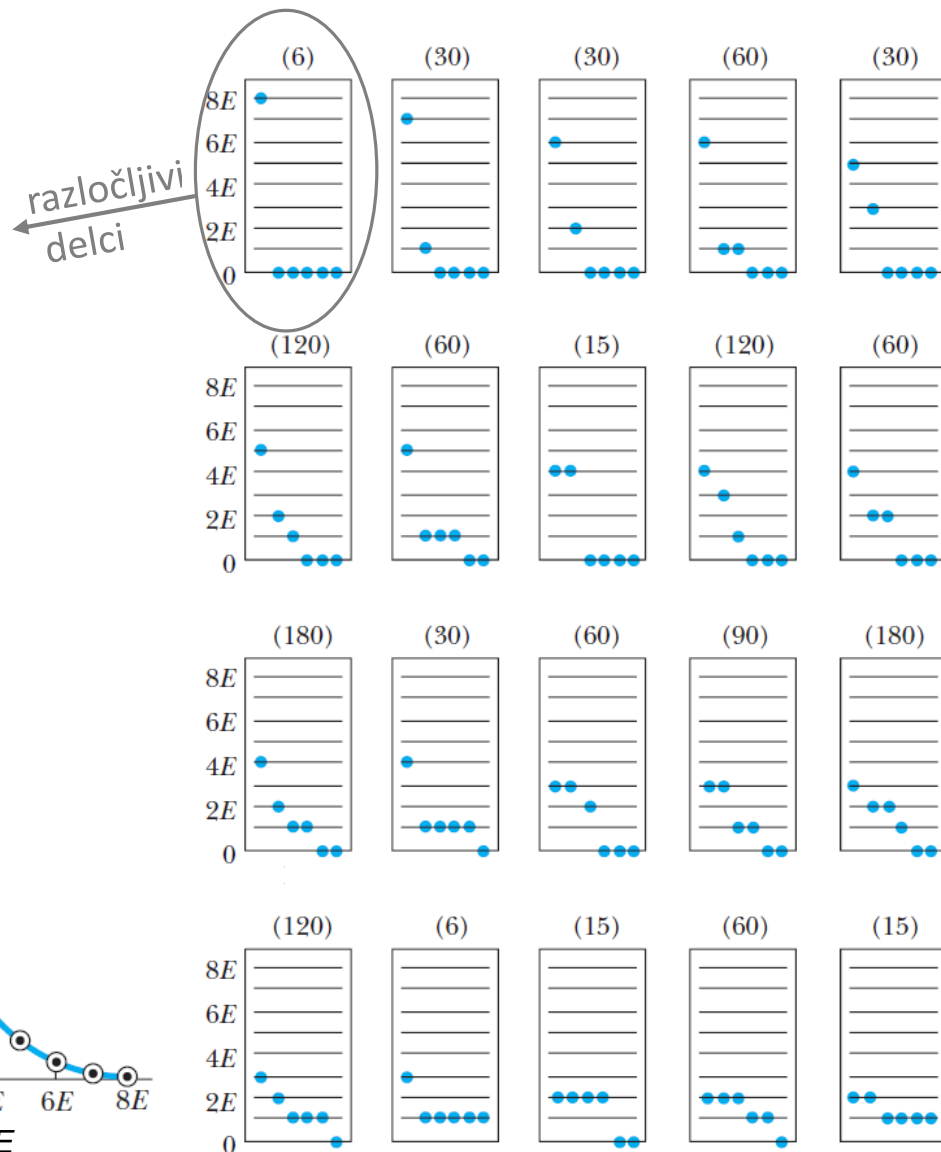
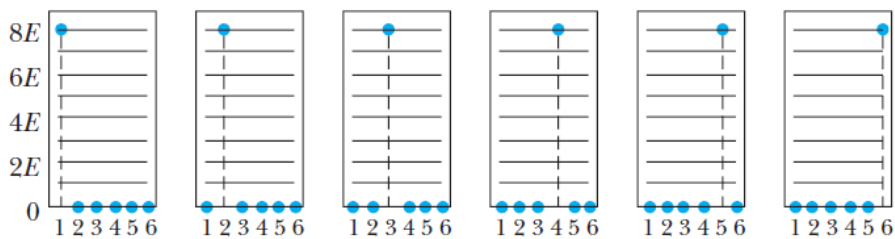

➤ Št. mikrostanj za konfiguracijo:

$$N_{MB} = \frac{N!}{N_1!N_2!\dots}$$

➤ Št. vseh mikrostanj:

$$N_0 = 1287$$

➤ Verjetnost za konfiguracijo:

$$p_{MB} = \frac{N_{MB}}{N_0}$$

➤ Povprečna zasedenost:

$$\bar{N}_i = \sum_j N_i^j p_{MB}^j$$

➤ Verjetnost za energijo E_i :

$$f_i = \frac{\bar{N}_i}{6}$$

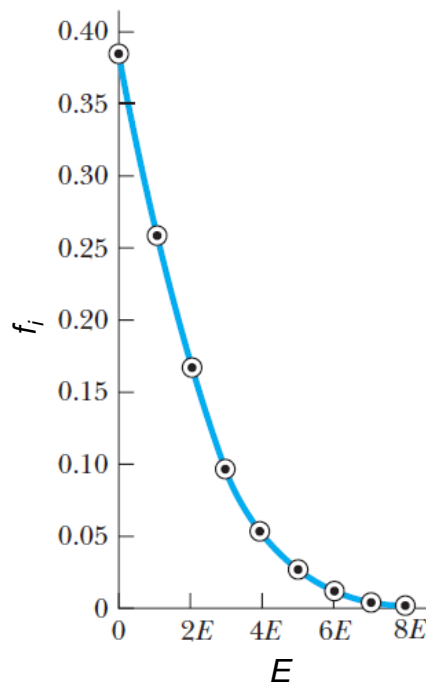

Vir: povzeto po Serway, Moses & Moyer, Modern Physics, Thomson Learning, 2005

8.1 Maxwell-Boltzmannova porazdelitev

➤ Osnovne predpostavke:

1. fiksno število identičnih delcev
2. fiksna skupna energija

DISKRETNA PORAZDELITEV

➤ Porazdelitvena funkcija:

$$f_{MB}^i = A e^{-E_i/k_B T}$$

➤ Degeneracija/gostota stanj (razpoložljiva stanja):

$$g^i$$

➤ Število zasedenih stanj:

$$N^i = g_i f_{MB}^i$$

➤ Normalizacija:

$$N = \sum_i N^i = \sum_i g^i f_{MB}^i$$

ZVEZNA PORAZDELITEV

$$f_{MB}(E) = A e^{-E/k_B T}$$

$$g(E)$$

$$n(E)dE = g(E)f_{MB}(E)dE$$

$$\frac{N}{V} = \int_0^\infty n(E)dE = \int_0^\infty g(E)f_{MB}(E)dE$$

8.1 Maxwell-Boltzmannova porazdelitev

- Porazdelitev hitrosti molekul plina (točkasti neinteragirajoči delci): Maxwell I. 1859

- Gostota stanj v prostoru hitrosti:

$$g(v)dv = C4\pi v^2 dv$$

- Porazdelitev hitrosti:

$$\begin{aligned} n(E)dE &= n(v)dv \\ &= 4\pi \frac{N}{V} \left(\frac{m}{2\pi k_B T} \right)^{3/2} v^2 e^{-mv^2/(2k_B T)} dv \end{aligned}$$

- Povprečna hitrosti:

$$\bar{v} = \sqrt{\frac{8k_B T}{\pi m}} \quad \sqrt{\overline{v^2}} = \sqrt{\frac{3k_B T}{m}} \quad \leftarrow \text{EKVIPARTICIJSKI IZREK}$$

- Pogoj veljavnosti MB statistike:

$$\left(\frac{N}{V} \right) \frac{\hbar^3}{8(mk_B T)^{3/2}} \ll 1$$

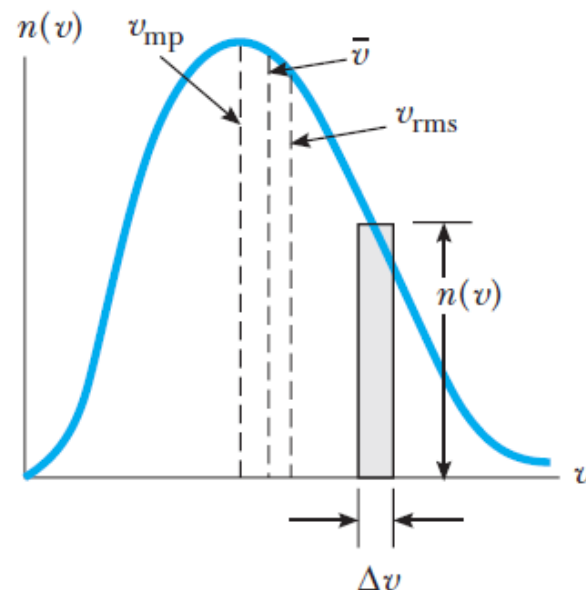
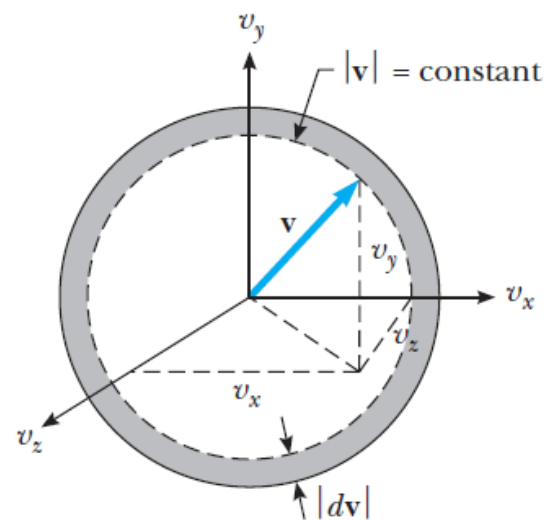

Vir: povzeto po Serway, Moses & Moyer, Modern Physics, Thomson Learning, 2005

8.2 Kvantna statistika

➤ Kvantna narava delcev spremeni njihovo statistiko pri:

1. velikih gostotah delcev
2. majhnih masah delcev
3. nizkih temperaturah

$$\left(\frac{N}{V}\right) \frac{\hbar^3}{8(mk_B T)^{3/2}} > 1$$

➤ Klasični (razločljivi) delci:

$$\psi_{MB} = \psi_a(\vec{r}_1)\psi_b(\vec{r}_2)$$

$$a = b \quad \psi_{MB} = \psi_a(\vec{r}_1)\psi_a(\vec{r}_2) \quad |\psi_{MB}|^2 = |\psi_a(\vec{r}_1)|^2|\psi_a(\vec{r}_2)|^2$$

➤ Kvantni (nerazločljivi) delci:

a) bozoni

$$\psi_b = \frac{1}{\sqrt{2}} [\psi_a(\vec{r}_1)\psi_b(\vec{r}_2) + \psi_a(\vec{r}_2)\psi_b(\vec{r}_1)]$$

$$a = b \quad \psi_b = \sqrt{2}\psi_a(\vec{r}_1)\psi_a(\vec{r}_2) \quad |\psi_b|^2 = 2|\psi_a(\vec{r}_1)|^2|\psi_a(\vec{r}_2)|^2 = 2|\psi_{MB}|^2$$

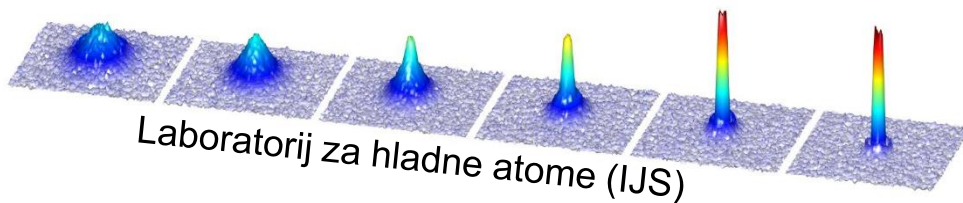

BOSE-EINSTEINOVA
KONDEZNACIJA

b) fermioni

$$\psi_f = \frac{1}{\sqrt{2}} [\psi_a(\vec{r}_1)\psi_b(\vec{r}_2) - \psi_a(\vec{r}_2)\psi_b(\vec{r}_1)]$$

$$a = b \quad \psi_f = \sqrt{2} [\psi_a(\vec{r}_1)\psi_a(\vec{r}_2) - \psi_a(\vec{r}_2)\psi_a(\vec{r}_1)] = 0 \quad |\psi_f|^2 = 0$$

PAULIJEVO
IZKLJUČITVENO NAČELO

SIMULACIJA

Vir: internet

8.2 Kvantna statistika

➤ *Primer: 6 bozonov s skupno energijo $8E$*

➤ konfiguracija = mikrostanje

➤ Porazdelitvena funkcija: f_i

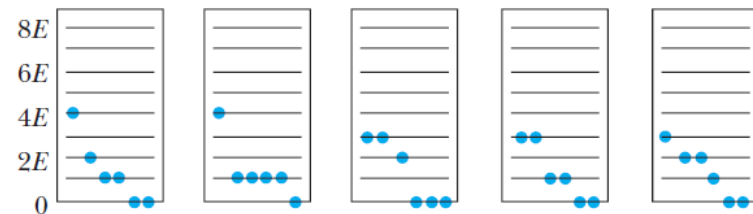
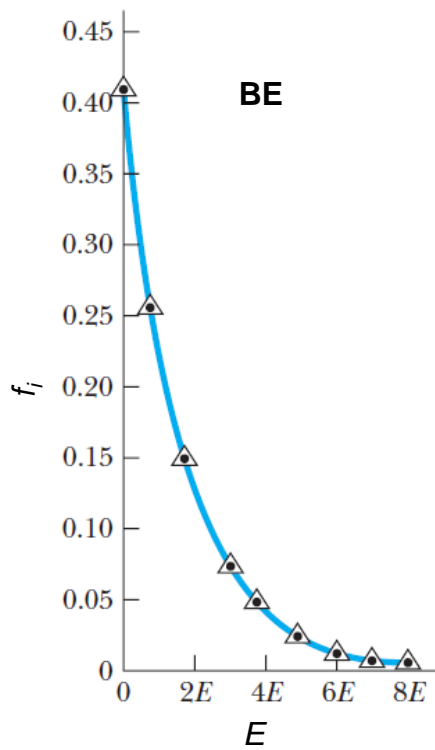
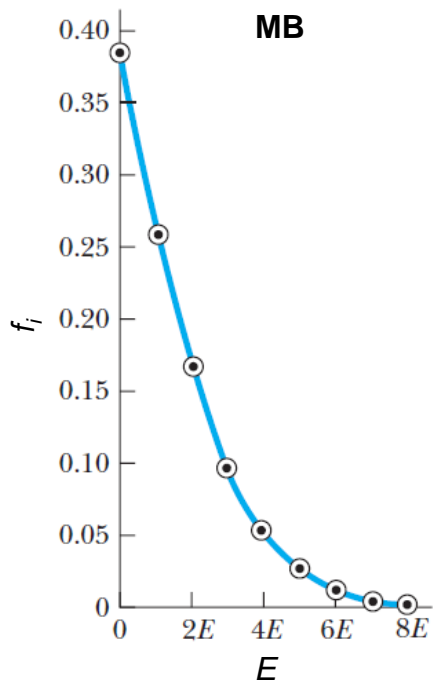

Vir: povzeto po Serway, Moses & Moyer, Modern Physics, Thomson Learning, 2005

8.2 Kvantna statistika

- *Primer: 6 fermionov (spin 1/2) s skupno energijo $8E$*
- konfiguracija = mikrostanje
- Porazdelitvena funkcija: f_i

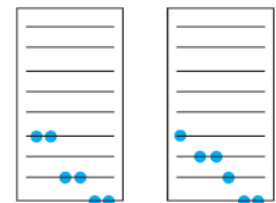
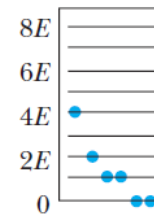
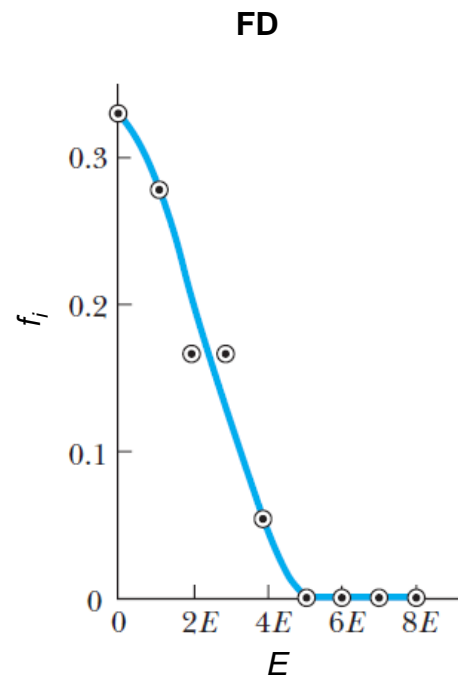
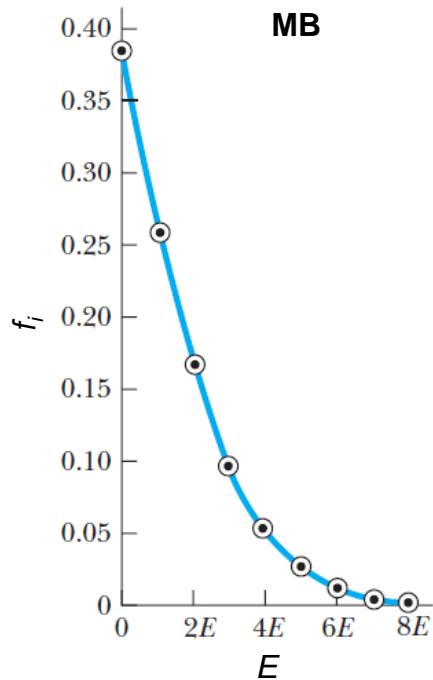

Vir: povzeto po Serway, Moses & Moyer, Modern Physics, Thomson Learning, 2005

8.2 Kvantna statistika

- Bose-Einsteinova (BE) in Fermi-Diracova (FD) porazdelitev:
- Porazdelitvena funkcija (zvezna):

BOZONI

$$f_{BE}(E) = \frac{1}{B e^{E/k_B T} - 1}$$

$$\frac{N}{V} = \int_0^\infty \frac{g(E) dE}{B e^{E/k_B T} - 1}$$

(št. delcev ni fiksno)

$$\frac{N}{V} = \int_0^\infty \frac{g(E) dE}{e^{E/k_B T} - 1}$$

FERMIONI

$$f_{FD}(E) = \frac{1}{F e^{E/k_B T} + 1}$$

$$\frac{N}{V} = \int_0^\infty \frac{g(E) dE}{F e^{E/k_B T} + 1}$$

Fermijeva energija

$$F = e^{-E_F/k_B T}$$

$$\frac{N}{V} = \int_0^\infty \frac{g(E) dE}{e^{(E-E_F)/k_B T} + 1}$$

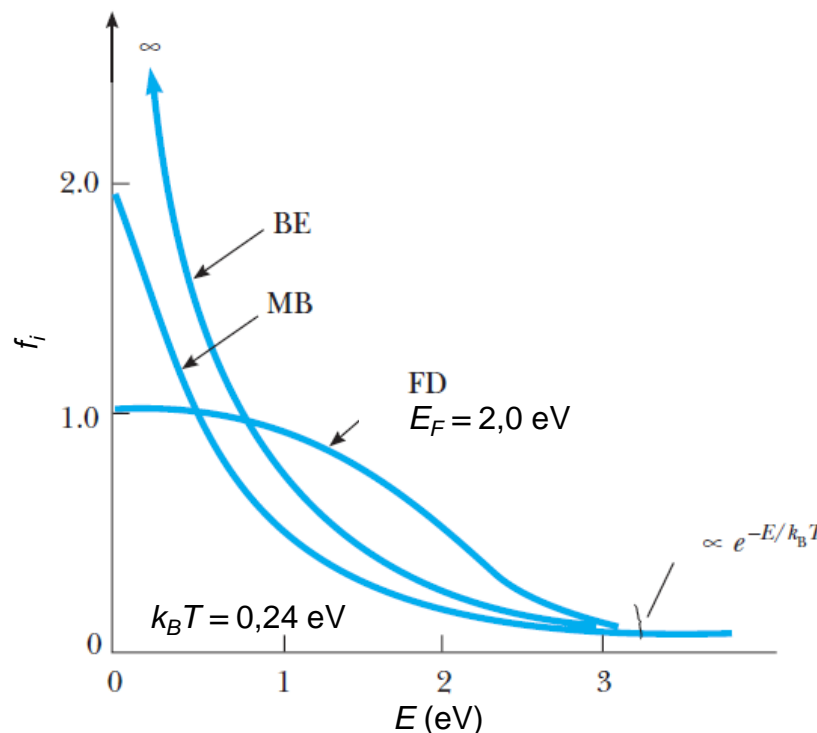

Vir: povzeto po Serway, Moses & Moyer, Modern Physics, Thomson Learning, 2005

8.3 Primeri uporabe kvantne statistike

➤ Fermijev plin: elektroni (spin $S = 1/2$) v kovinah kot plin s Fermi-Diracovo statistiko:

Št. zasedenih stanj:

$$n(E)dE = g(E)f_{FD}(E)dE$$

$$f_{FD}(E) = \frac{1}{e^{(E-E_F)/k_B T} + 1}$$

$$g(E)dE = 4\pi \left(\frac{2m}{h^2}\right)^{3/2} \sqrt{E}dE$$

$$\frac{N}{V} = \int_0^\infty 4\pi \left(\frac{2m}{h^2}\right)^{3/2} \frac{\sqrt{E}dE}{e^{(E-E_F)/k_B T} + 1}$$

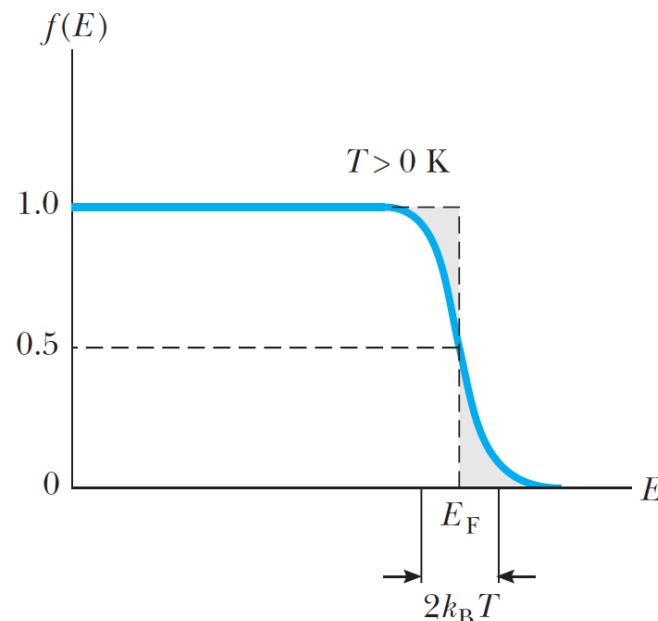
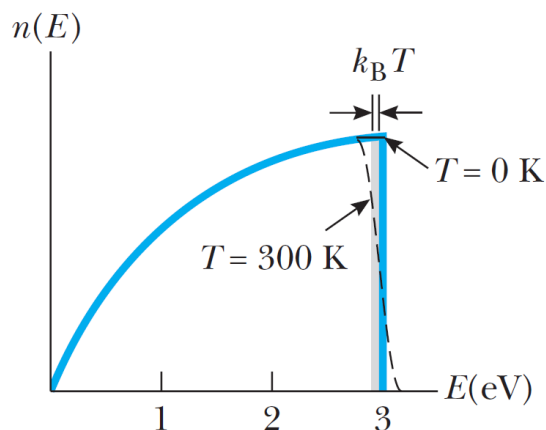

$$E_F(T = 0) = \frac{h^2}{2m} \left(\frac{3}{8\pi} \frac{N}{V}\right)^{2/3}$$

Fermijeva hitrost

$$v_F = \sqrt{\frac{2E_F}{m_e}}$$

Fermijeva temperatura

$$T_F = \frac{E_F}{k_B T}$$

Vir: povzeto po Serway, Moses & Moyer, Modern Physics, Thomson Learning, 2005

8.3 Primeri uporabe kvantne statistike

- Sevanje črnega telesa: fotoni (spin $S = 1$) kot plin z Bose-Einsteinovo statistiko:

Št. zasedenih stanj:

$$n(E)dE = g(E)f_{BE}(E)dE$$

$$f_{BE}(E) = \frac{1}{e^{E/k_B T} - 1}$$

$$g(E)dE = \frac{8\pi}{(hc)^3} E^2 dE$$

Gostota energijskega toka:

$$u(E)dE = E g(E) f_{BE}(E) dE$$

$$\frac{dj}{d\nu} = \frac{c}{4} u(\nu) = \frac{2\pi h}{c^2} \frac{\nu^3}{e^{h\nu/k_B T} - 1}$$

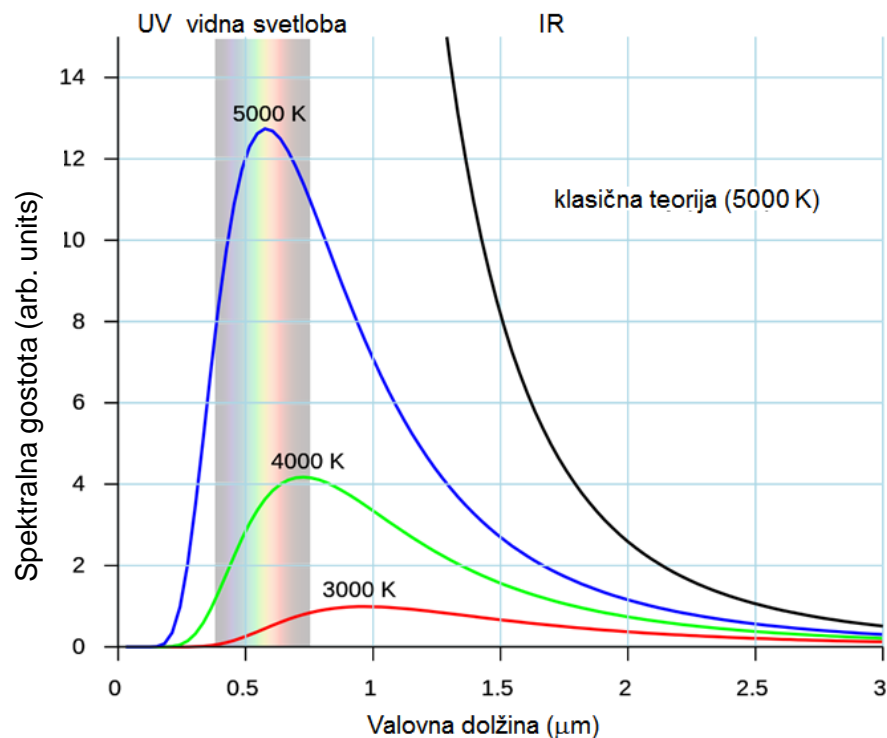

8.3 Primeri uporabe kvantne statistike

- Bose-Einsteinova kondenzacija: plin bozonov s fiksnim številom delcev

Št. zasedenih stanj:

$$n(E)dE = g(E)f_{BE}(E)dE$$

$$f_{BE}(E) = \frac{1}{Be^{E/k_B T} - 1}$$

$$g(E)dE = 2\pi \left(\frac{2m}{h^2}\right)^{3/2} \sqrt{E}dE$$

$$\frac{N}{V} = \frac{N_0}{V} + 2\pi \left(\frac{2m}{h^2}\right)^{3/2} \int_0^\infty \frac{\sqrt{E}dE}{Be^{E/k_B T} - 1}$$

$$N_0 = N - 2\pi V \left(\frac{2m}{h^2}\right)^{3/2} I(1)(k_B T)^{3/2}$$

$$I(1) = \int_0^\infty \frac{\sqrt{z}dz}{e^z - 1} = 2,6 \frac{\sqrt{\pi}}{2}$$

Temperature prehoda:

$$T_{BE} = \left(\frac{N}{V} \frac{1}{2\pi I(1)}\right)^{2/3} \frac{h^2}{2mk_B}$$

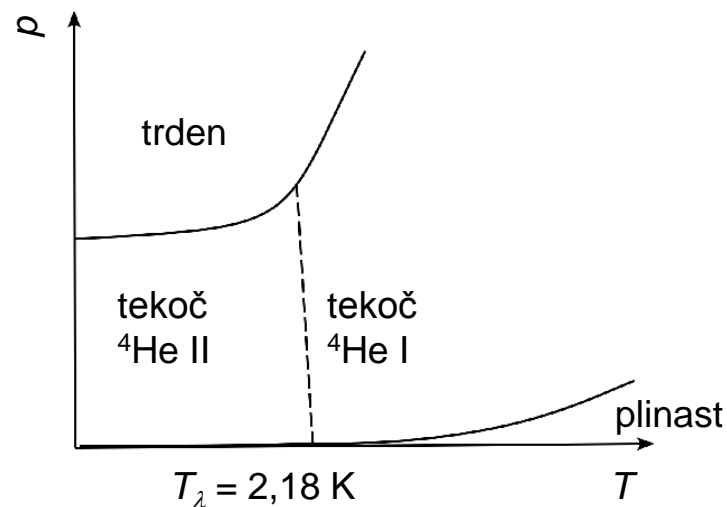

SIMULACIJA

Vir: internet

8.3 Primeri uporabe kvantne statistike

- Bose-Einsteinova kondenzacija v eksperimentu s hladnimi atomi:

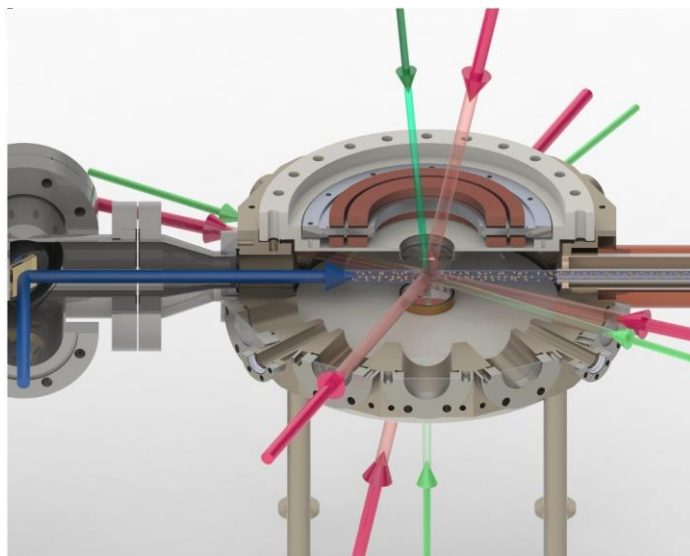

The Nobel Prize in Physics 2001



Eric A. Cornell
Prize share: 1/3



Wolfgang Ketterle
Prize share: 1/3



Carl E. Wieman
Prize share: 1/3

The Nobel Prize in Physics 2001 was awarded jointly to Eric A. Cornell, Wolfgang Ketterle and Carl E. Wieman *"for the achievement of Bose-Einstein condensation in dilute gases of alkali atoms, and for early fundamental studies of the properties of the condensates"*.

Porazdelitev hitrosti (BEC):

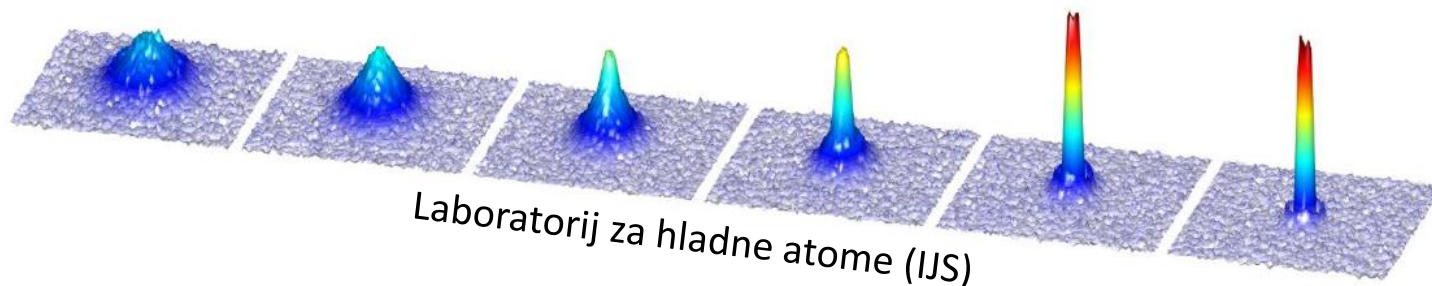

Vir: internet

8.4 Laserji

➤ Širok spekter: SIMULACIJA

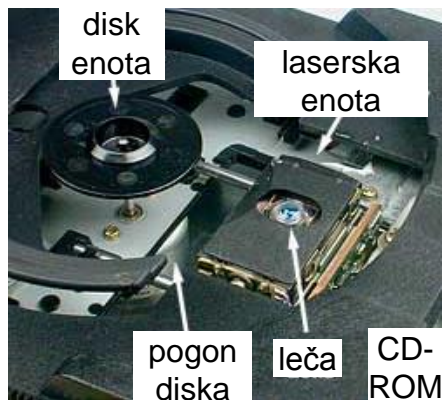

Vir: internet

The Nobel Prize in Physics 1964



Charles Hard Townes
Prize share: 1/2



Nicolay Gennadiyevich Basov
Prize share: 1/4



Aleksandr Mikhailovich Prokhorov
Prize share: 1/4

The Nobel Prize in Physics 1964 was divided, one half awarded to Charles Hard Townes, the other half jointly to Nicolay Gennadiyevich Basov and Aleksandr Mikhailovich Prokhorov *"for fundamental work in the field of quantum electronics, which has led to the construction of oscillators and amplifiers based on the maser-laser principle"*.

Physikalische Zeitschrift 18, 121 1917

The Quantum Theory of Radiation

A. Einstein

(Received March, 1917)

8.4 Laserji

- Prehodi med nivoji:

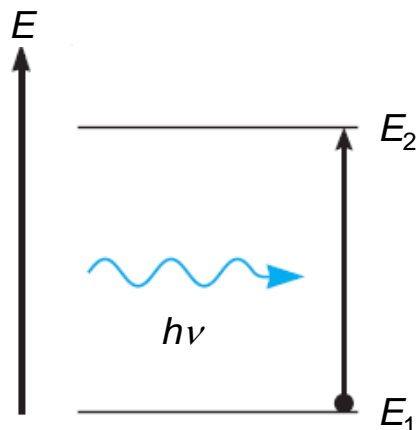

absorpcija

$$h\nu = E_2 - E_1$$

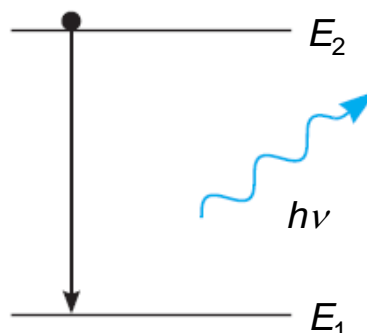

spontana emisija
(nekoherentna)

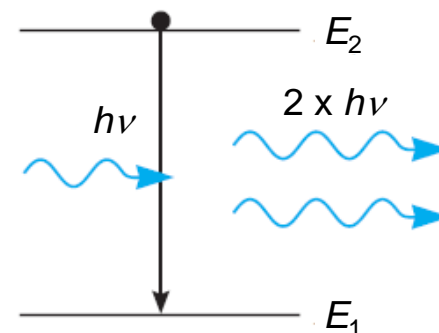

stimulirana emisija
(koherentna)

- Verjetnosti za prehod na časovno enoto:

$$w_{12}(\nu, T) = B_{12}u(\nu, T)$$

$$w_{21}^{sp} = A_{21}$$

$$w_{21}^{st}(\nu, T) = B_{21}u(\nu, T)$$

- Termično ravnovesje (dinamično):

$$\frac{N_2}{N_1} = e^{-h\nu/(k_B T)}$$

$$N_1 w_{12}(\nu, T) = N_2 [w_{21}^{sp} + w_{21}^{st}(\nu, T)]$$

$$u(\nu, T) = \frac{A_{21}}{B_{12}e^{h\nu/(k_B T)} - B_{21}} = \frac{8\pi h}{c^3} \frac{\nu^3}{e^{h\nu/(k_B T)} - 1}$$

$$B_{21} = B_{12} = B$$

$$A_{12} = \frac{8\pi h\nu^3}{c^3}$$

Vir: povzeto po Serway, Moses & Moyer, Modern Physics, Thomson Learning, 2005

8.4 Laserji

➤ Osnovni principi delovanja:

1. Inverzna populacija: $N_2 > N_1 \Rightarrow N_2 w_{21}^{st}(\nu, T) > N_1 w_{12}(\nu, T)$ (ojačitev svetlobe = „lasing“)

2. Laserski medij:

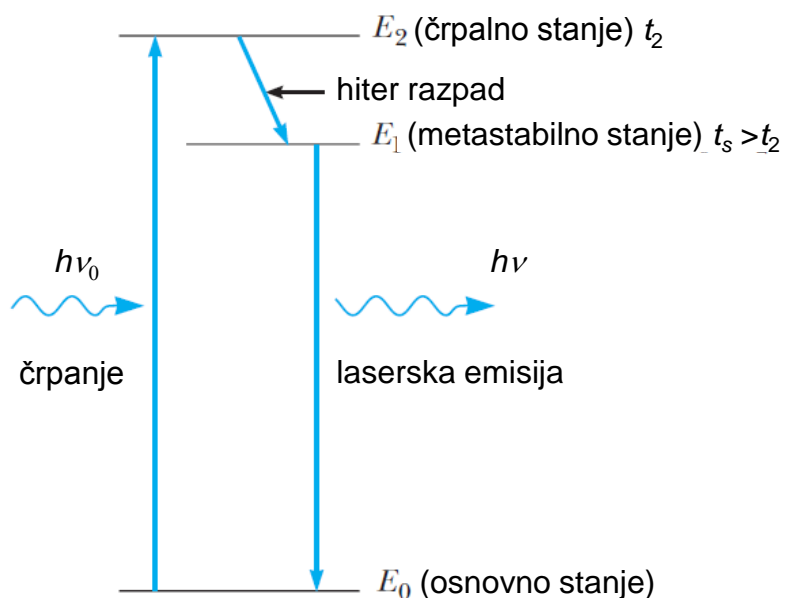

3. Optični resonator

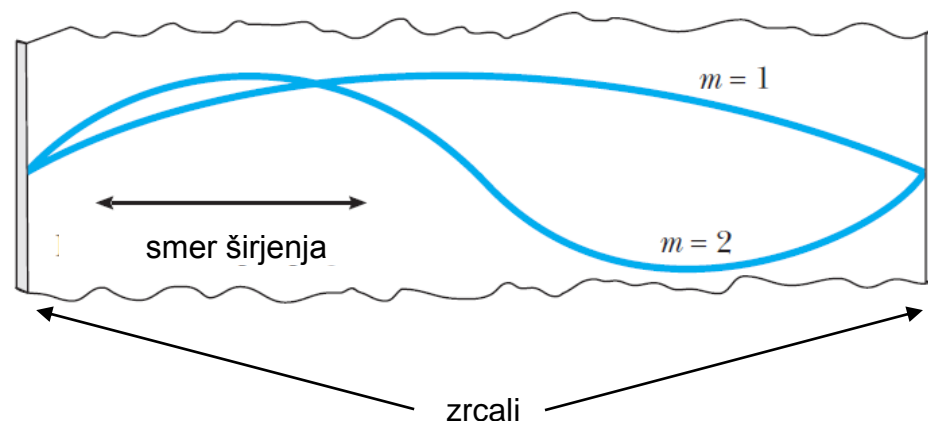

➤ Osnovne lastnosti:

- monokromatičnost
- velika intenziteta
- prostorska koherenca
- majhna divergenca

SIMULACIJA

Vir: povzeto po Serway, Moses & Moyer, Modern Physics, Thomson Learning, 2005

8.4 Laserji

► Tipi laserjev:

1. PLINSKI (He-Ne)

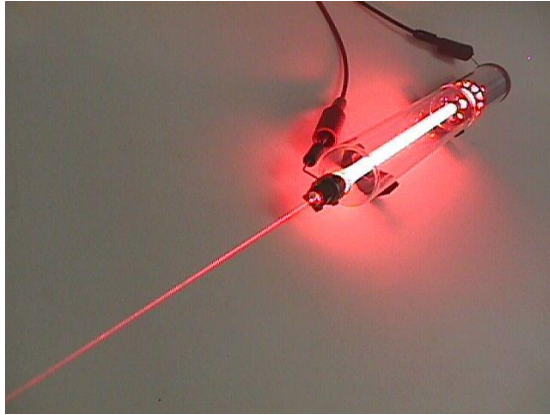

2. TRDNI KRISTALNI (Nd: YAG)

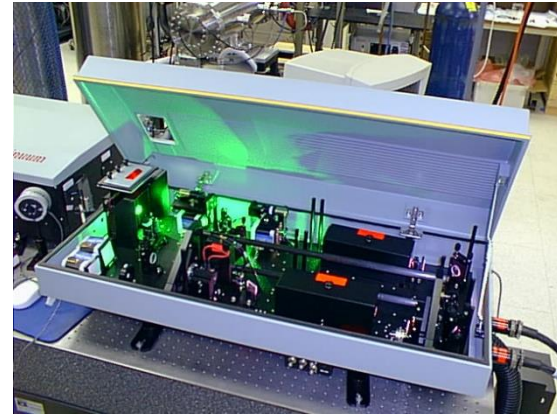

3. POLPREVODNIŠKI

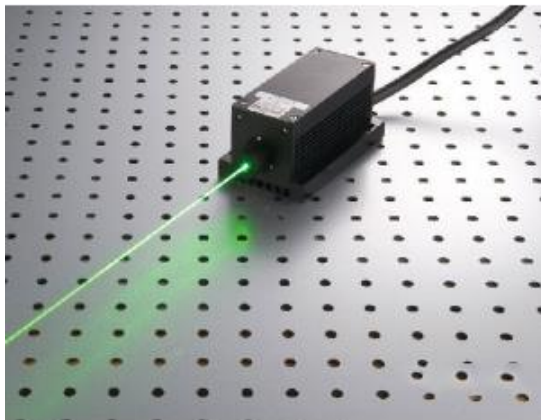

4. PROSTO-ELEKTRONSKI

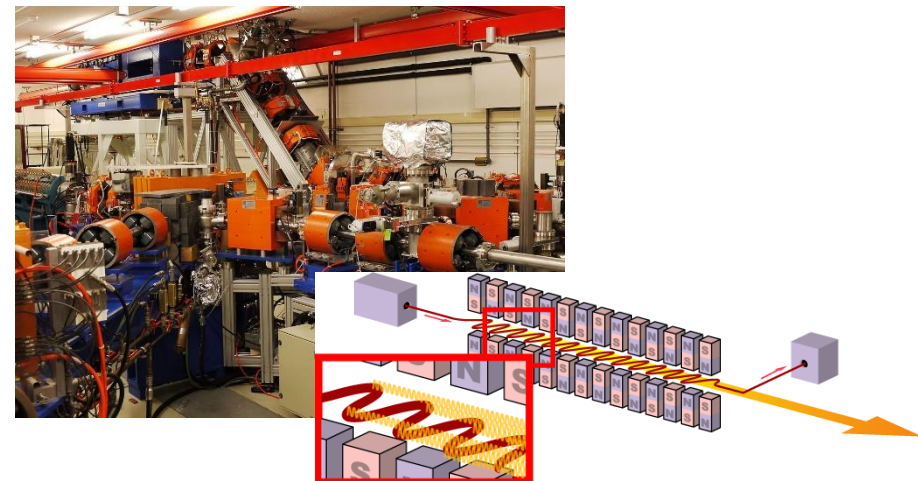

Vir: internet



MODERNA FIZIKA

Trdna snov

9.1 Povezovanje atomov v trdni snovi

1. Ionski kristali:

$$U(r) = -\alpha \frac{e^2}{4\pi\epsilon_0 r} + \frac{B}{r^m} + E_{ion} - E_{af}$$

Madelungova konstanta: $\alpha = 6 \times 1 - 12 \times \frac{1}{\sqrt{2}} + 8 \times \frac{1}{\sqrt{3}} - \dots$

Polna energija

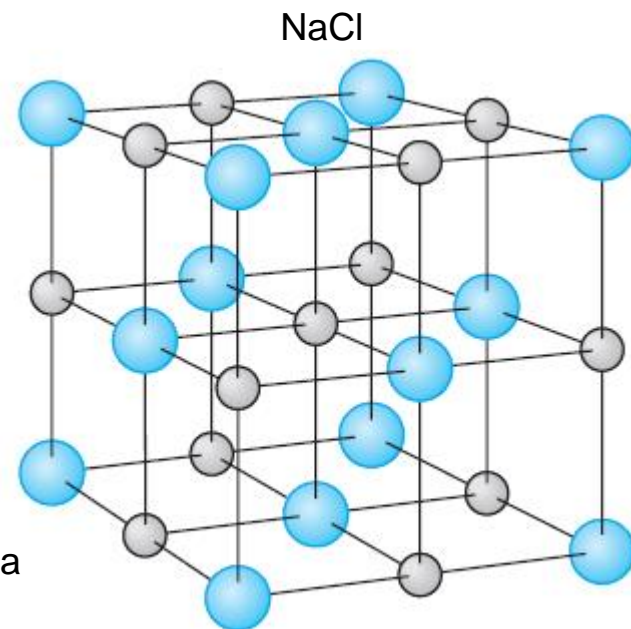
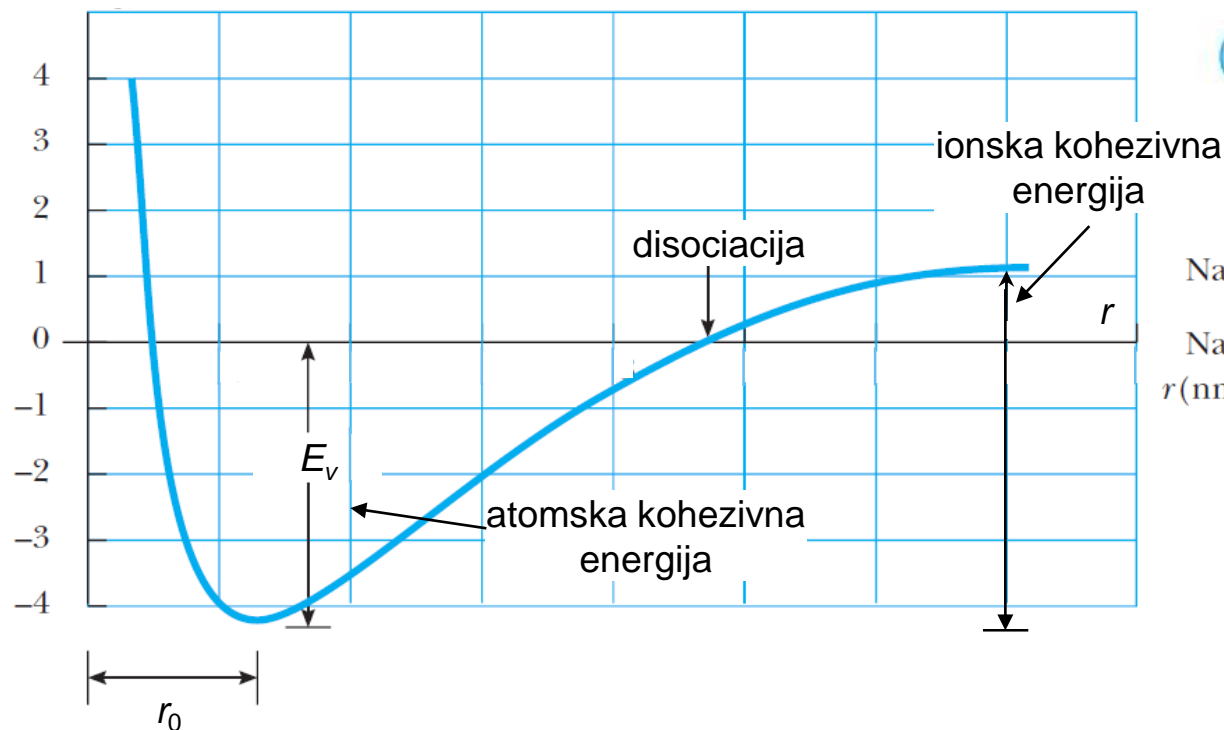

Na⁺ + Cl⁻
Na + Cl
r(nm)



Vir: povzeto po Serway, Moses & Moyer, Modern Physics, Thomson Learning, 2005

9.1 Povezovanje atomov v trdni snovi

2. Kovalentni kristali (diamant):

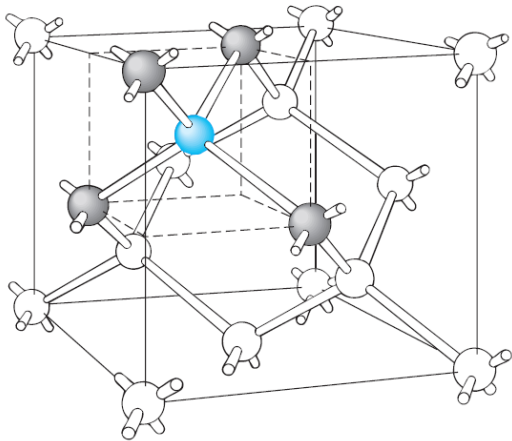

3. Kovinski kristali (Cu, Au, Na,...):

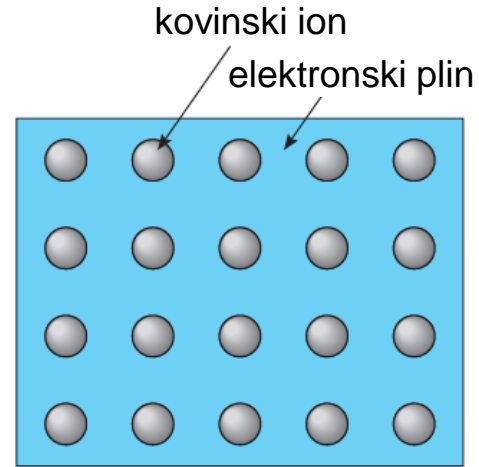

4. Molekularni kristali (kristal sladkorja):

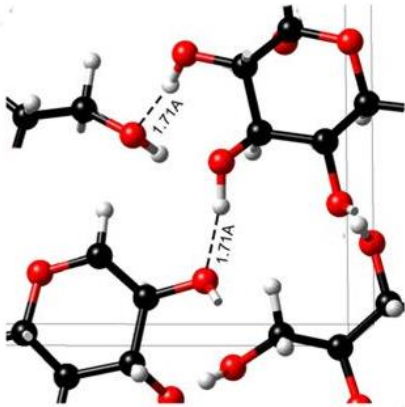

5. Amorfne snovi:

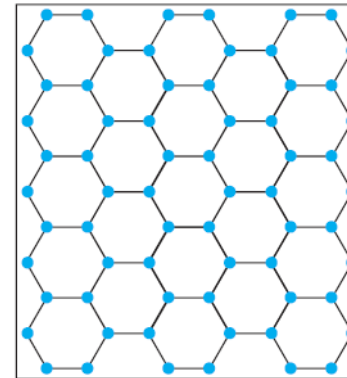

kristal

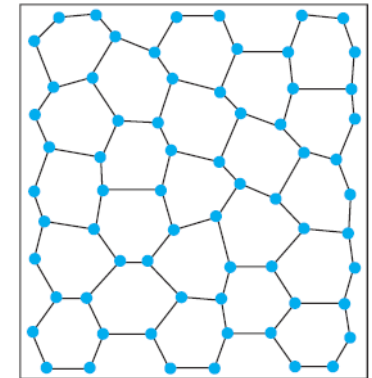

steklo

Vir: internet; povzeto po Serway, Moses & Moyer, Modern Physics, Thomson Learning, 2005

9.2 Določanje kristalne strukture

➤ Braggov uklon:

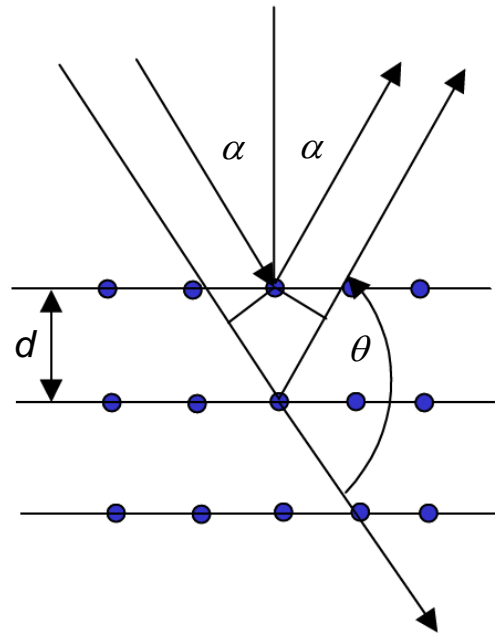

$$2d \cos \alpha = n\lambda \qquad 2d \sin \frac{\theta}{2} = n\lambda$$

Vir: internet

The Nobel Prize in Physics 1915



Sir William Henry Bragg

Prize share: 1/2



William Lawrence Bragg

Prize share: 1/2

The Nobel Prize in Physics 1915 was awarded jointly to Sir William Henry Bragg and William Lawrence Bragg *"for their services in the analysis of crystal structure by means of X-rays"*



9.2 Določanje kristalne strukture

➤ Lauejeva metoda merjenja:

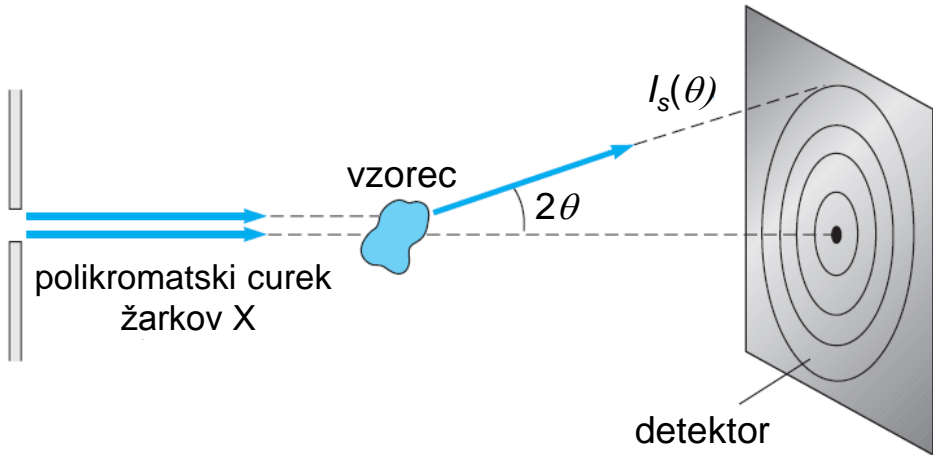

The Nobel Prize in Physics 1914



Max von Laue
Prize share: 1/1

The Nobel Prize in Physics 1914 was awarded to Max von Laue "for his discovery of the diffraction of X-rays by crystals".

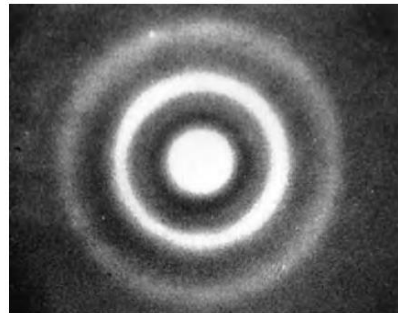

amorfn Fe

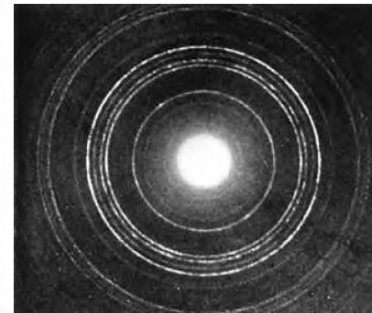

kristal Fe

Vir: internet; povzeto po Serway, Moses & Moyer, Modern Physics, Thomson Learning, 2005

9.3 Pasovna struktura elektronskih stanj v kristalih

➤ Tvorba elektronskih pasov:

2 atoma:

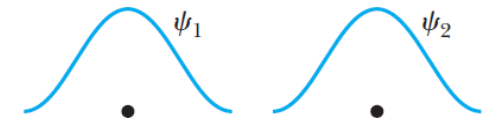
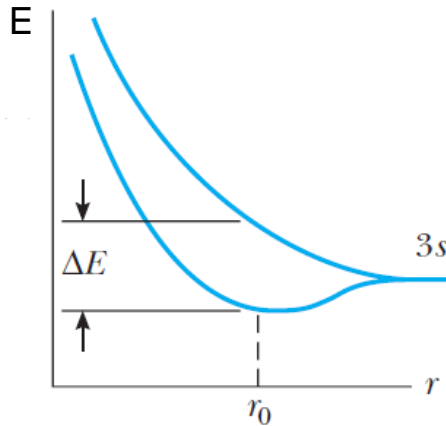

vezano stanje:



nevezano stanje:

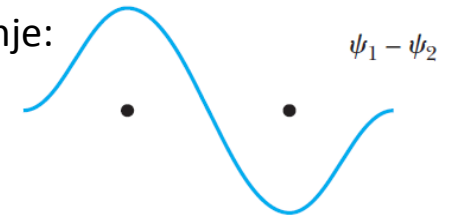

N atomov:

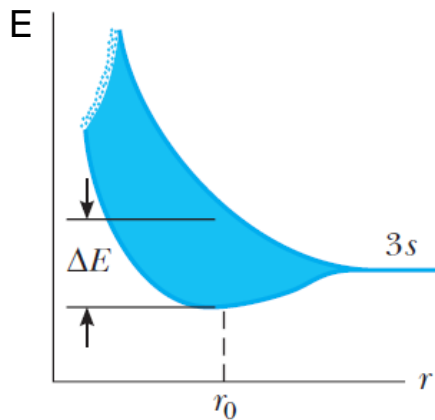

Vir: povzeto po Serway, Moses & Moyer, Modern Physics, Thomson Learning, 2005

9.3 Pasovna struktura elektronskih stanj v kristalih

➤ Električna prevodnost:

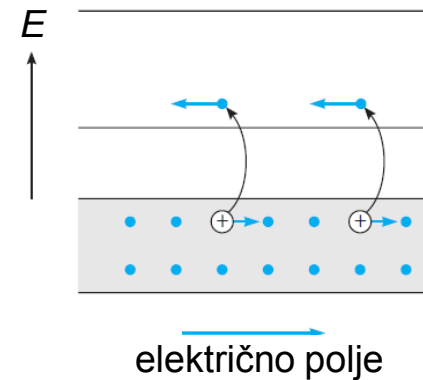
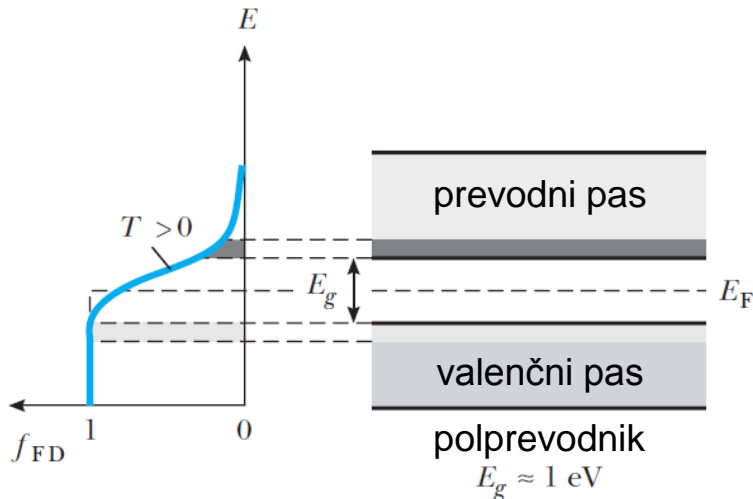
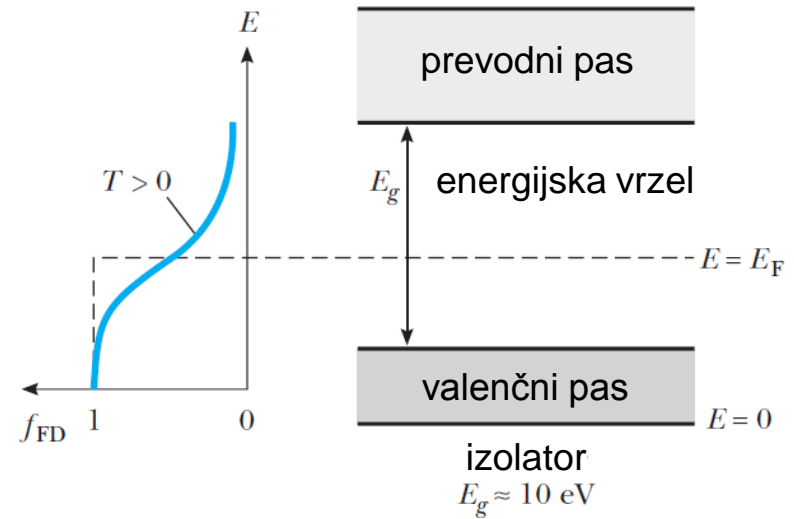
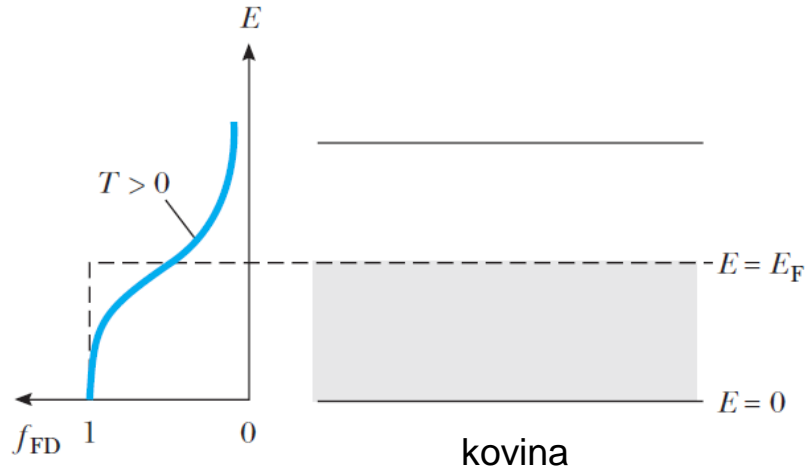

Vir: povzeto po Serway, Moses & Moyer, Modern Physics, Thomson Learning, 2005

9.3 Pasovna struktura elektronskih stanj v kristalih

- Efekt periodičnega potenciala:

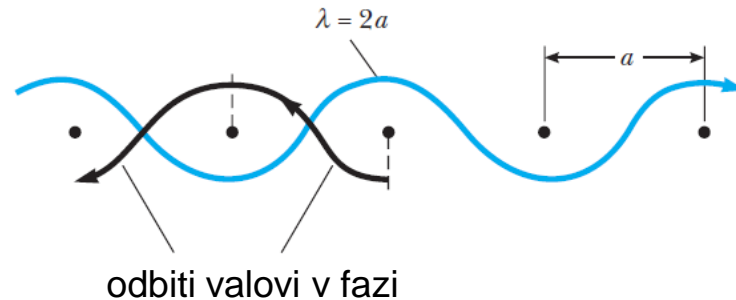
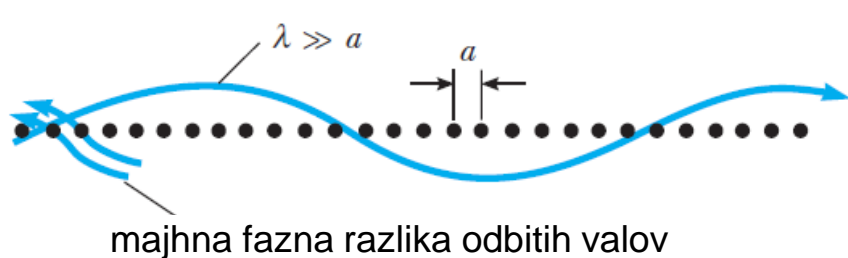

- Konstruktivna interferenca odbitih valov: $2a = n\lambda \Rightarrow k_n = \frac{\pi}{a}n$

$$\psi_+ = A \left[e^{i(kx - \omega t)} + e^{i(-kx - \omega t)} \right]$$

$$\psi_- = A \left[e^{i(kx - \omega t)} - e^{i(-kx - \omega t)} \right]$$

$$k = \frac{\pi}{a}$$

$$|\psi_+|^2 = 4|A|^2 \cos^2 \frac{\pi x}{a}$$

$$|\psi_-|^2 = 4|A|^2 \sin^2 \frac{\pi x}{a}$$

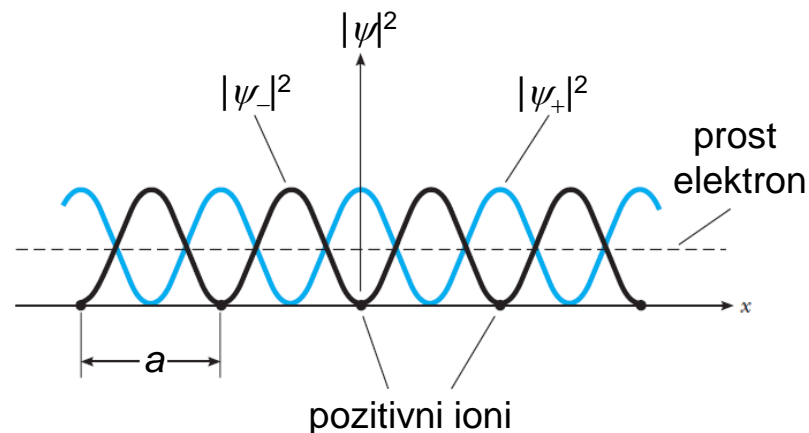

Vir: povzeto po Serway, Moses & Moyer, Modern Physics, Thomson Learning, 2005

9.3 Pasovna struktura elektronskih stanj v kristalih

➤ Efekt periodičnega potenciala:

$$E_p = \frac{\hbar^2 k^2}{2m}$$

$$k_n = \frac{\pi}{a} n \quad E_+ < E_p < E_-$$

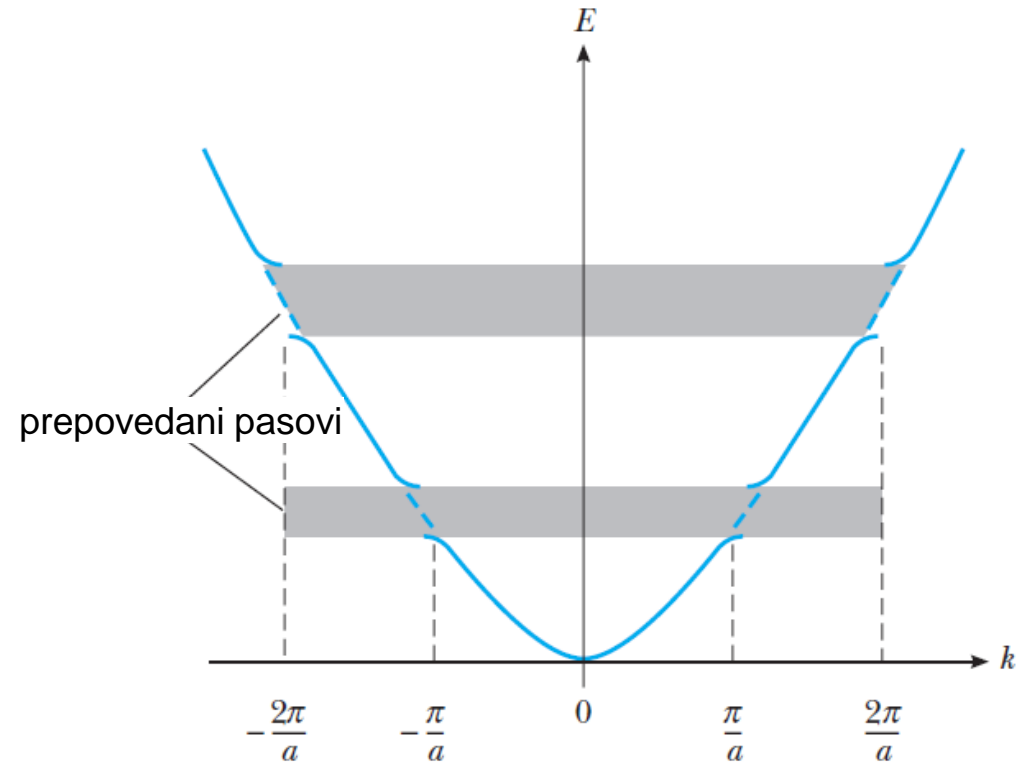

SIMULACIJA

Vir: povzeto po Serway, Moses & Moyer, Modern Physics, Thomson Learning, 2005

9.4 Drudejev model elektronov v kovini

- Klasični model elektronskega plina:

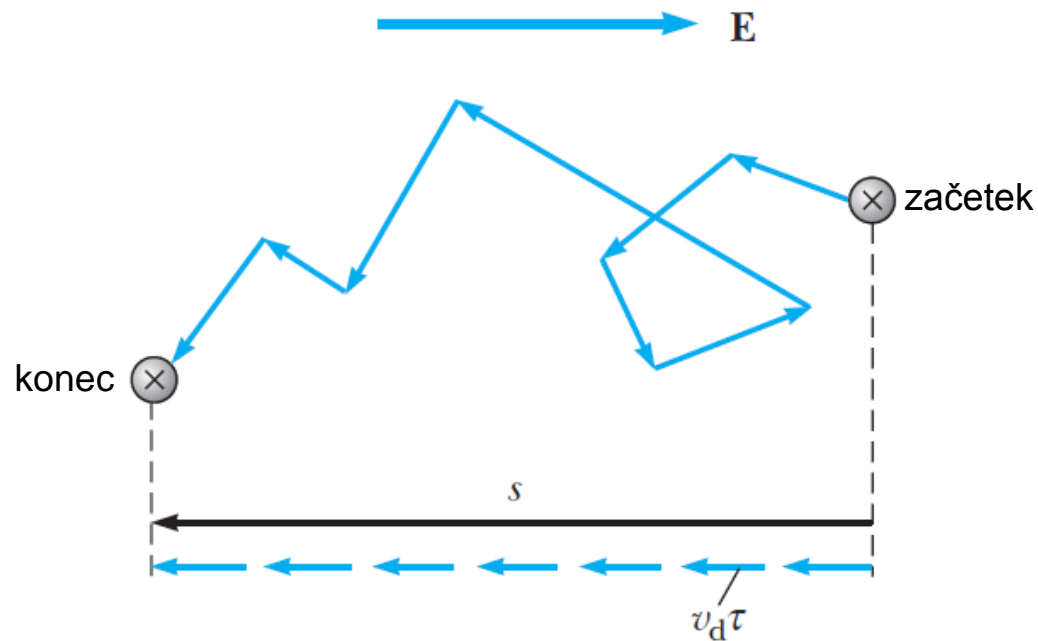
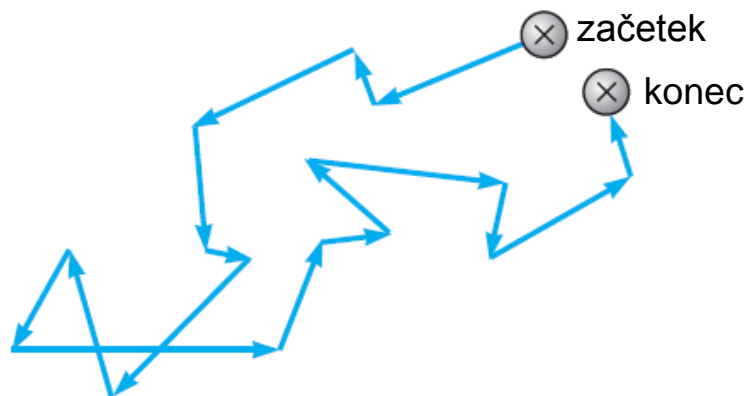

- termična hitrost: $v_t = \left(\frac{3k_B T}{m}\right)^{1/2}$
- povprečna prosta pot: $L = v_t \tau$
- povpečna hitrost v el. polju: $v_d = \frac{eE}{m} \tau$
- Ohmov zakon: $j = \sigma E$ $\sigma = \frac{ne^2 \tau}{m} = \frac{ne^2 L}{m v_t}$

Vir: povzeto po Serway, Moses & Moyer, Modern Physics, Thomson Learning, 2005



9.5 Model Fermijevega plina

- Kvantni model elektronskega plina (Fermi-Diracova porazdelitev):

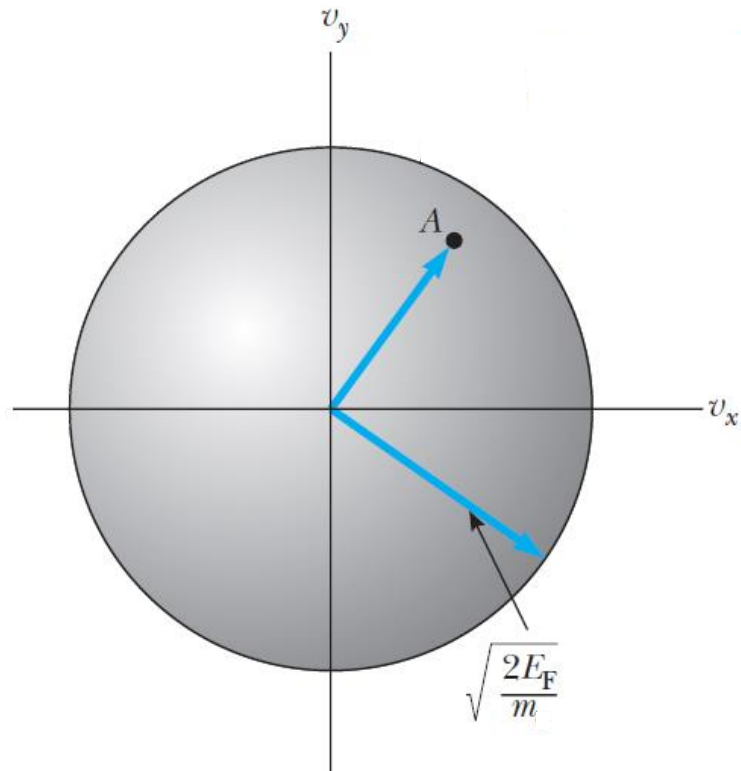

centrirana Fermijeva sfera

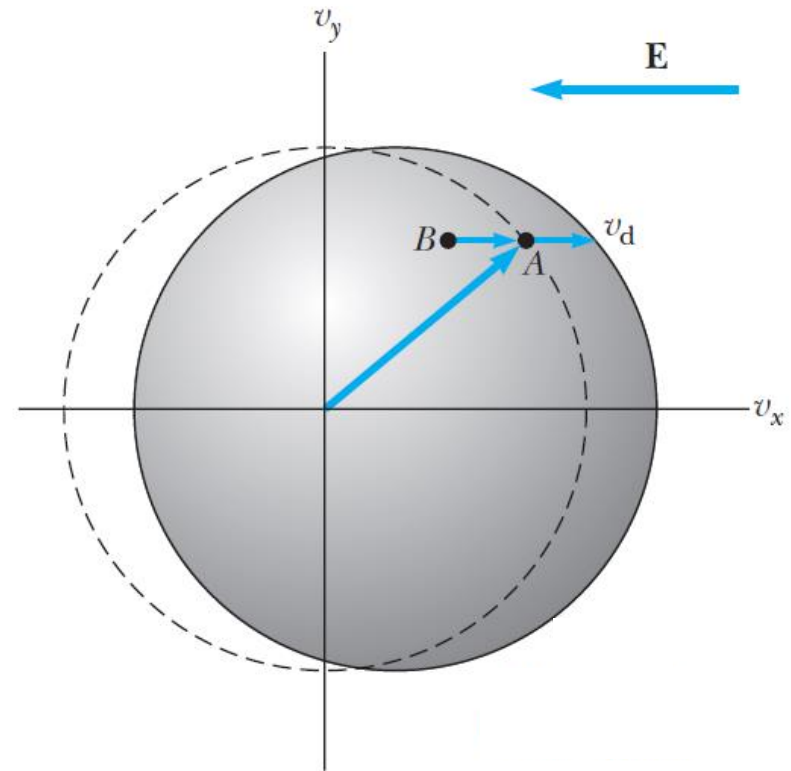

premknjena Fermijeva sfera

- Fermijeva hitrost: $L = v_F \tau$ $\sigma = \frac{ne^2 \tau}{m} = \frac{ne^2 L}{mv_F}$

Vir: povzeto po Serway, Moses & Moyer, Modern Physics, Thomson Learning, 2005

9.6 Čisti in dopirani polprevodniki

➤ Čisti polprevodnik:

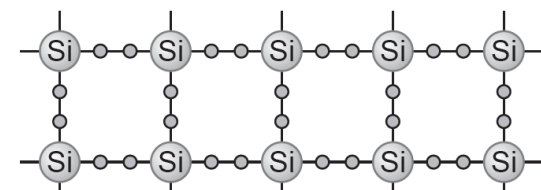

										14 28.086 Si Silicon								

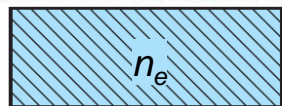

$$E_g = 1.1 \text{ eV}$$

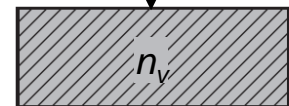

poln valenčni pas

$$n_e = n_v$$

➤ N-dopiran polprevodnik:

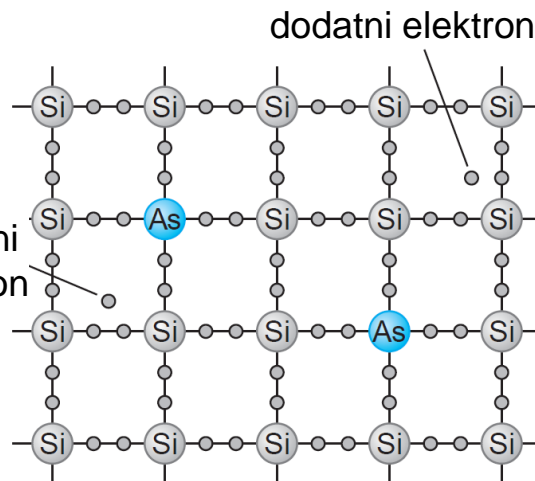

prazen prevodni pas

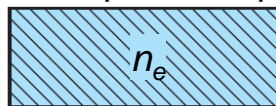

—●—● donorska
—●—● stanja

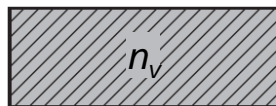

poln valenčni pas

$$n_e > n_v$$

➤ P-dopiran polprevodnik:

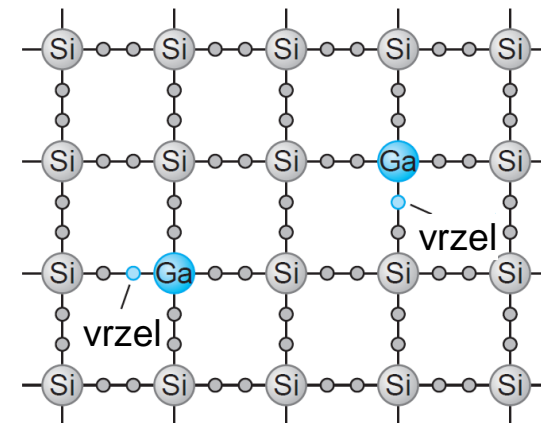

prazen prevodni pas

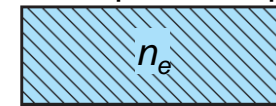

—●—● akceptorska
—●—● stanja

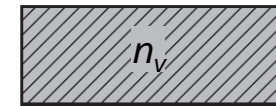

poln valenčni pas

$$n_e < n_v$$

Vir: povzeto po Tipler & Llewellyn, Modern Physics, W. H. Freeman and Company, 2012

9.6 Čisti in dopirani polprevodniki

Čisti polprevodnik:

➤ Gostota elektronov v prevodnem pasu:

$$\begin{aligned}
 n_e &= \int_{E_g}^{\infty} f_{FD} g(E) dE \\
 &= 4\pi \left(\frac{2m_e}{h^2} \right)^{3/2} \int_{E_g}^{\infty} \frac{1}{e^{(E-E_F)/k_B T} + 1} \sqrt{E - E_g} dE \\
 &= B_e (k_B T)^{3/2} e^{-(E_g - E_F)/k_B T} \\
 B_e &= 2 \left(\frac{2\pi m_e}{h^2} \right)^{3/2}
 \end{aligned}$$

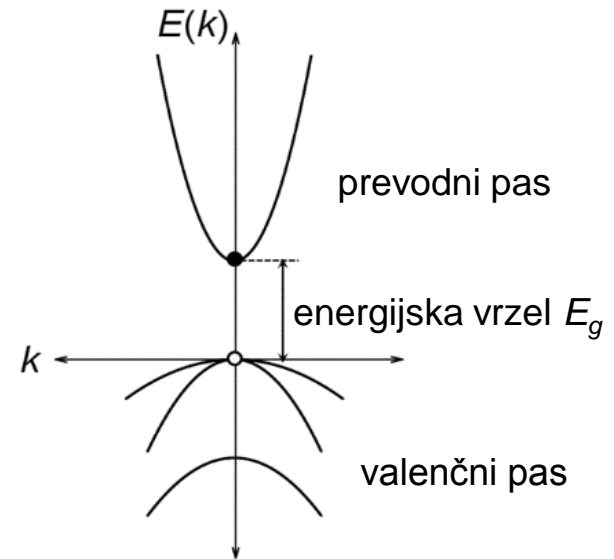

➤ Gostota vrzeli v valenčnem pasu:

$$\begin{aligned}
 n_v &= \frac{N}{V} - \int_{-\infty}^0 f_{FD} g(E) dE \\
 &= 4\pi \left(\frac{2m_v}{h^2} \right)^{3/2} \int_{-\infty}^0 \frac{1}{e^{-(E-E_F)/k_B T} + 1} \sqrt{-E} dE \\
 &= B_v (k_B T)^{3/2} e^{-E_F/k_B T} \\
 B_v &= 2 \left(\frac{2\pi m_v}{h^2} \right)^{3/2}
 \end{aligned}$$

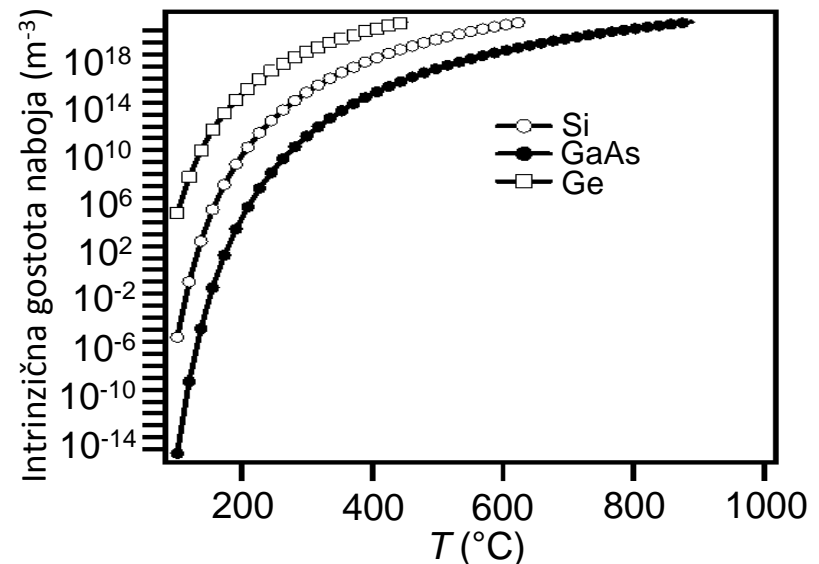

Vir: internet

9.6 Čisti in dopirani polprevodniki

Čisti polprevodnik:

➤ Fermijeva energija:

$$n_e = n_v \Rightarrow E_F = \frac{E_g}{2} + \frac{3}{4}k_B T \ln \frac{m_v}{m_e}$$

➤ Efektivna gostota stanj:

$$n_e n_v = n_0^2 e^{-E_g/k_B T}$$

$$n_0 = 2 \left(\frac{2\pi \sqrt{m_e m_v} k_B T}{h^2} \right)^{3/2}$$

➤ Prevajanje električnega toka:

$$\beta = \frac{\langle v \rangle}{E}$$

$$j = e_0(n_e \beta_e + n_v \beta_v) E$$

$$j = \sigma E = \frac{E}{\rho}$$

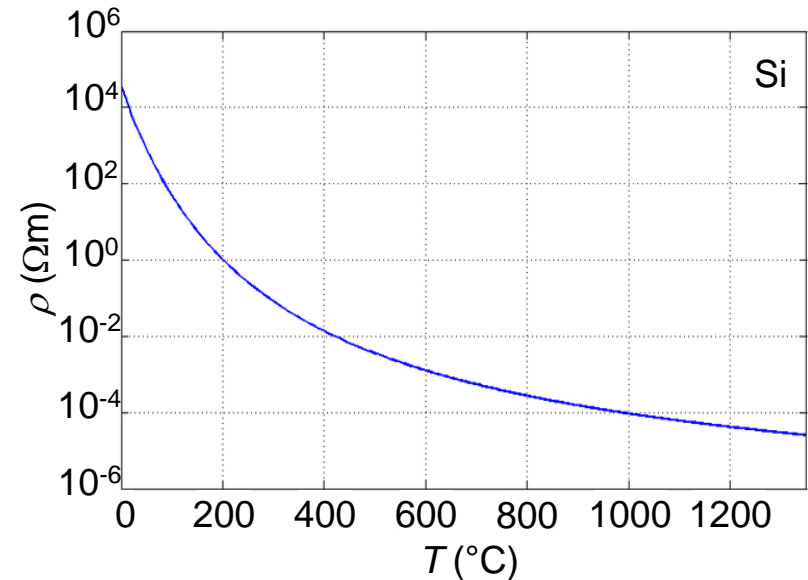
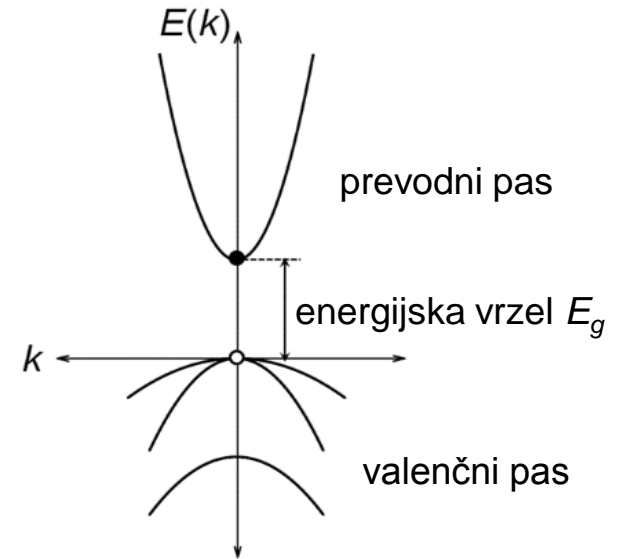

9.6 Čisti in dopirani polprevodniki

Dopiran polprevodnik:

$$n_e n_v = n_0^2 e^{-E_g/k_B T}$$
$$n_0 = 2 \left(\frac{2\pi \sqrt{m_e m_v} k_B T}{h^2} \right)^{3/2}$$

➤ tip n: $n_e = n_v + n_d [1 - f(E_g - E_d)]$

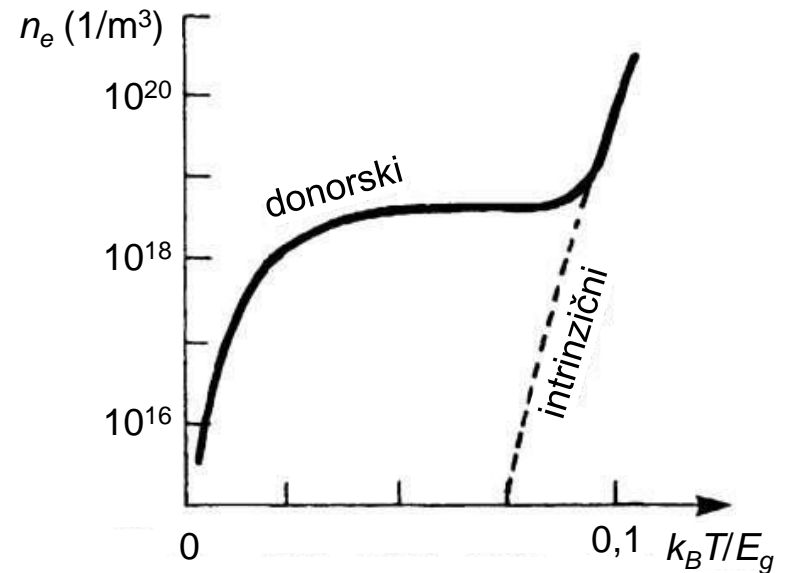
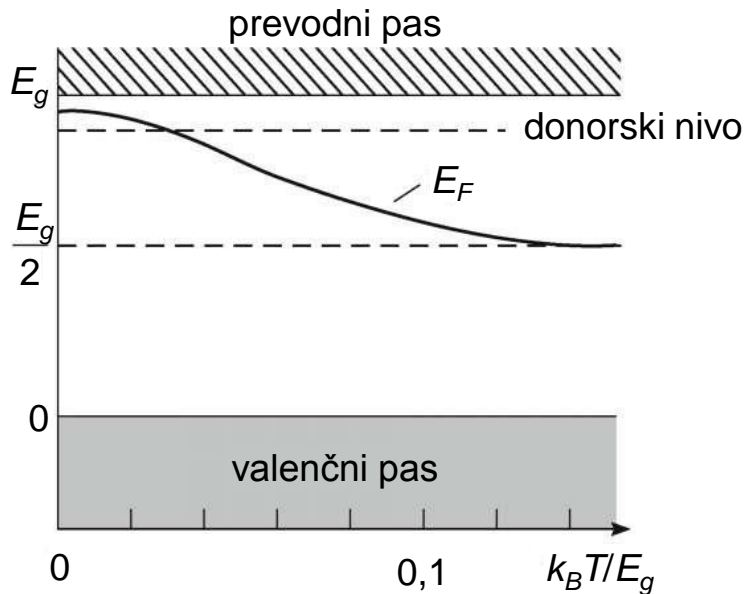

9.6 Čisti in dopirani polprevodniki

- Meritev večinskih nosilcev naboja: Hallov pojav

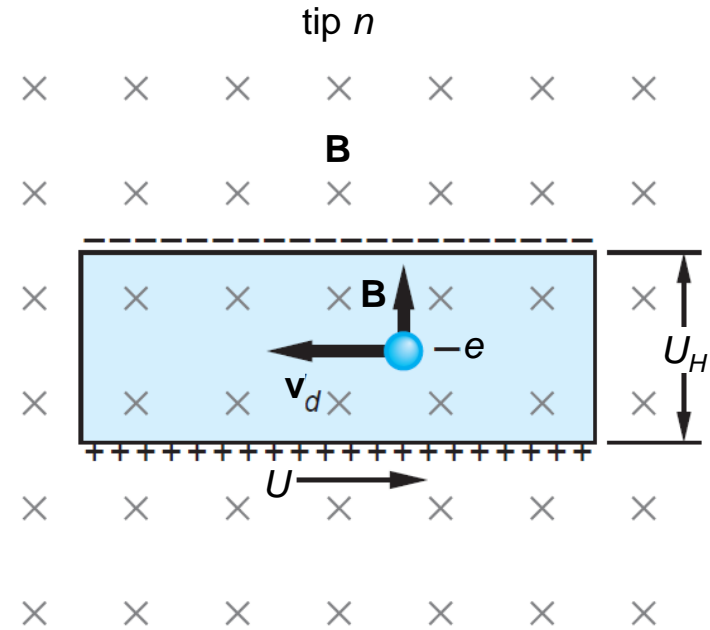
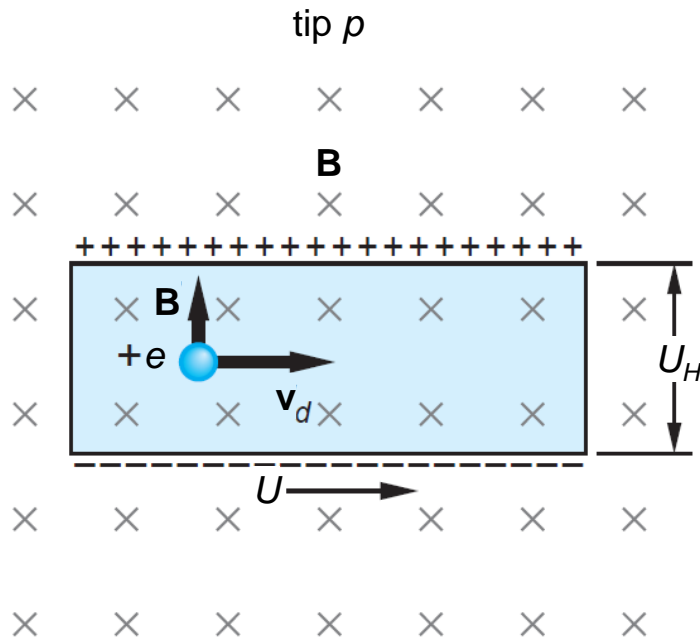

$$eE_H = e \frac{U_H}{a} = e \langle v \rangle B = \frac{j}{n} B = \frac{\sigma U}{cn} B$$

Vir: povzeto po Tipler & Llevellyn, Modern Physics, W. H. Freeman and Company, 2012

9.7 Stik p - n in polprevodniške naprave

➤ Stik p - n :
 depletirano področje
 donorski/akceptorski ioni

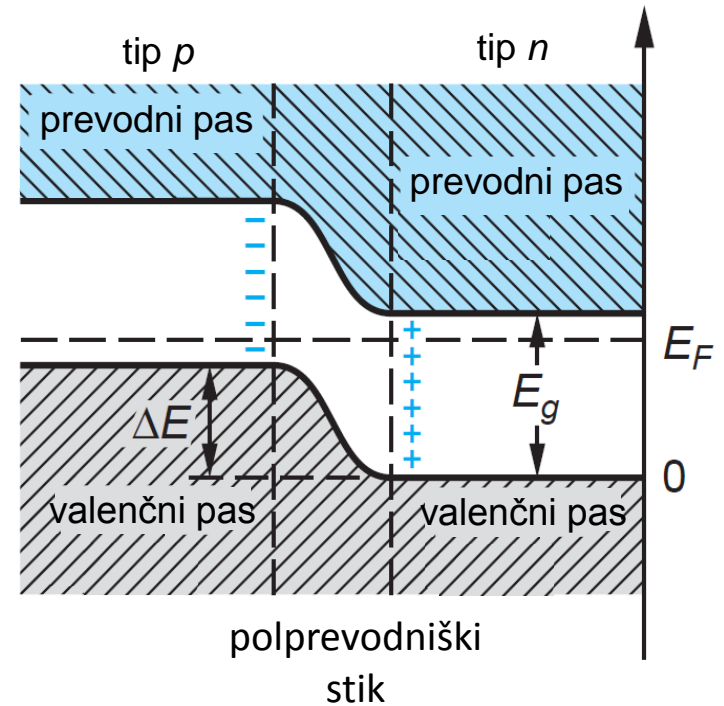
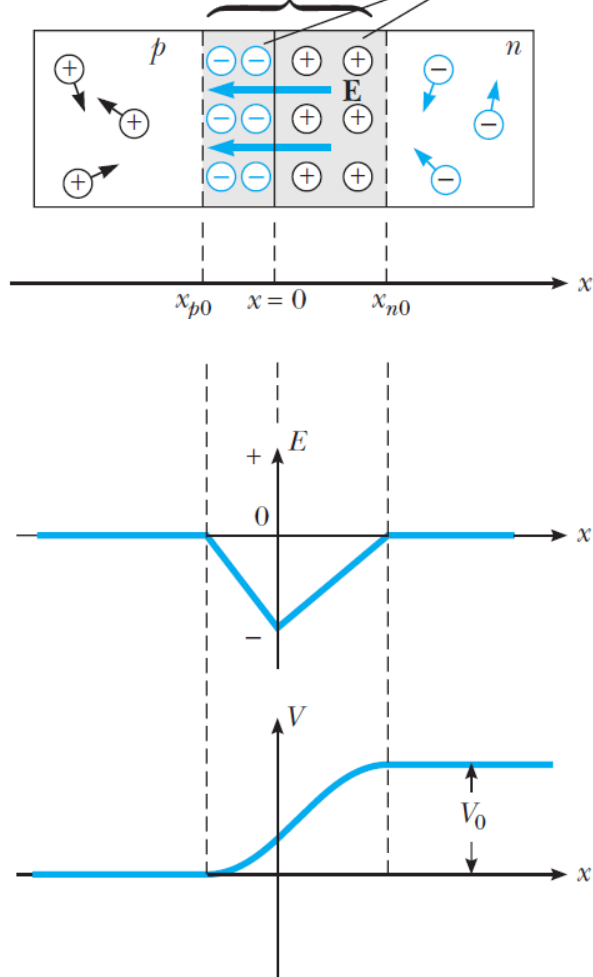

Vir: povzeto po Serway, Moses & Moyer, Modern Physics, Thomson Learning, 2005; Tipler & Llevellyn, Modern Physics, W. H. Freeman and Company, 2012

9.7 Stik p - n in polprevodniške naprave

➤ Polprevodniške naprave:

1. Usmerniška dioda:

$$I = I_0(e^{eU/K_B T} - 1)$$

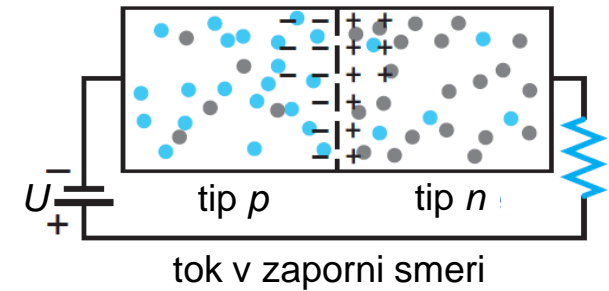
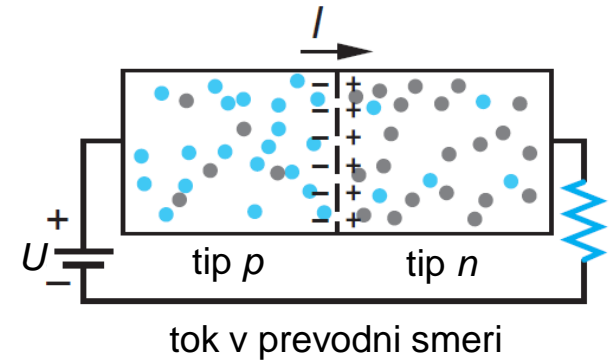
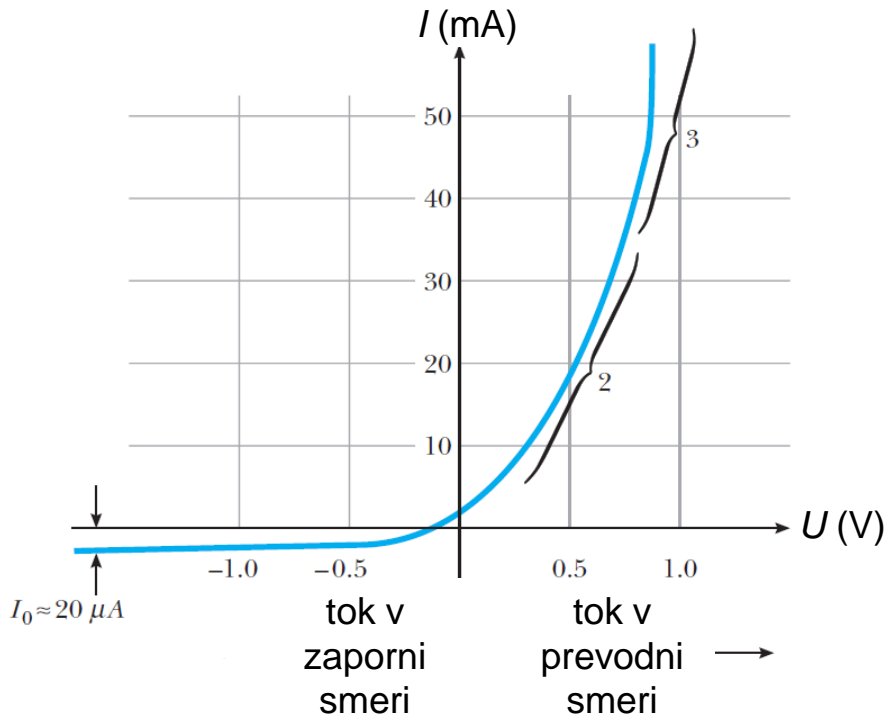

SIMULACIJA

Vir: povzeto po Serway, Moses & Moyer, Modern Physics, Thomson Learning, 2005; Tipler & Llevellyn, Modern Physics, W. H. Freeman and Company, 2012

9.7 Stik p - n in polprevodniške naprave

2. Solarna celica in LED:

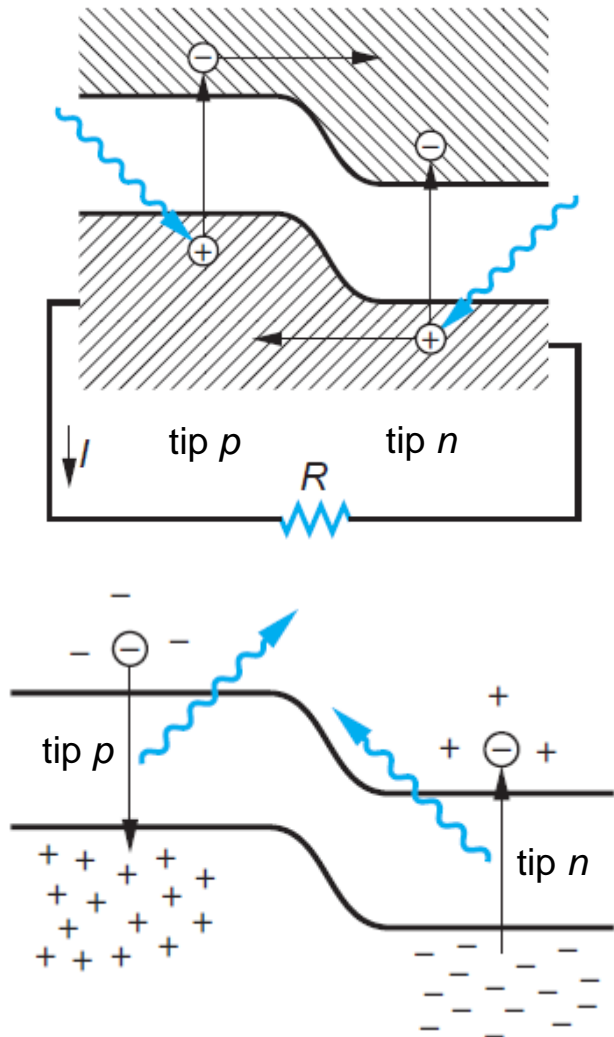

The Nobel Prize in Physics 2014



Photo: A. Mahmoud
Isamu Akasaki
Prize share: 1/3



Photo: A. Mahmoud
Hiroshi Amano
Prize share: 1/3



Photo: A. Mahmoud
Shuji Nakamura
Prize share: 1/3

The Nobel Prize in Physics 2014 was awarded jointly to Isamu Akasaki, Hiroshi Amano and Shuji Nakamura *"for the invention of efficient blue light-emitting diodes which has enabled bright and energy-saving white light sources"*.

Vir: internet; povzeto po Tipler & Llevellyn, Modern Physics, W. H. Freeman and Company, 2012

9.7 Stik p - n in polprevodniške naprave

3. Tranzistor:

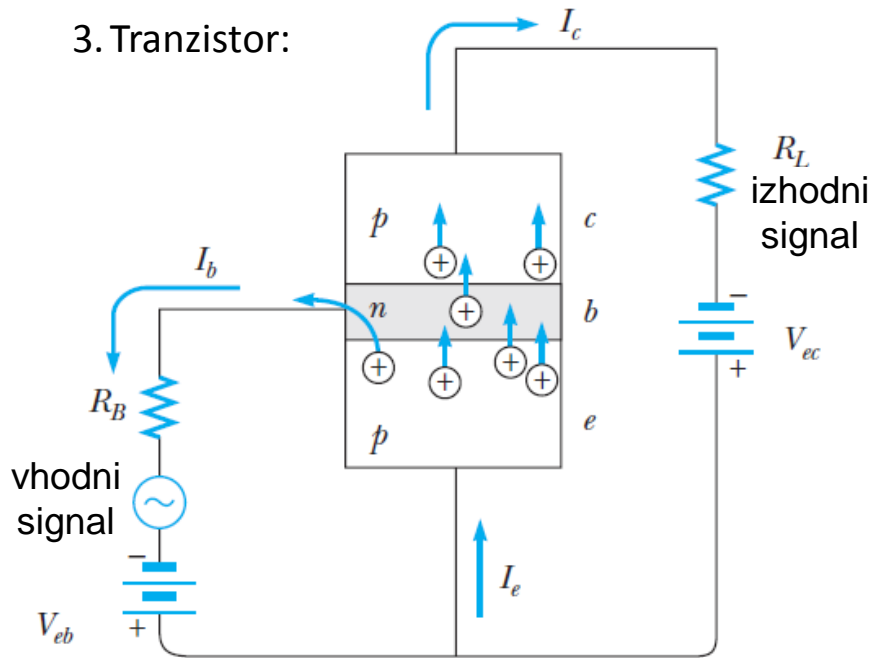

The Nobel Prize in Physics 1956



William Bradford Shockley
Prize share: 1/3



John Bardeen
Prize share: 1/3



Walter Houser Brattain
Prize share: 1/3

The Nobel Prize in Physics 1956 was awarded jointly to William Bradford Shockley, John Bardeen and Walter Houser Brattain "for their researches on semiconductors and their discovery of the transistor effect".



1907



1947



1963

Vir: internet; povzeto po Serway, Moses & Moyer, Modern Physics, Thomson Learning, 2005

9.7 Stik p - n in polprevodniške naprave

4. FET:

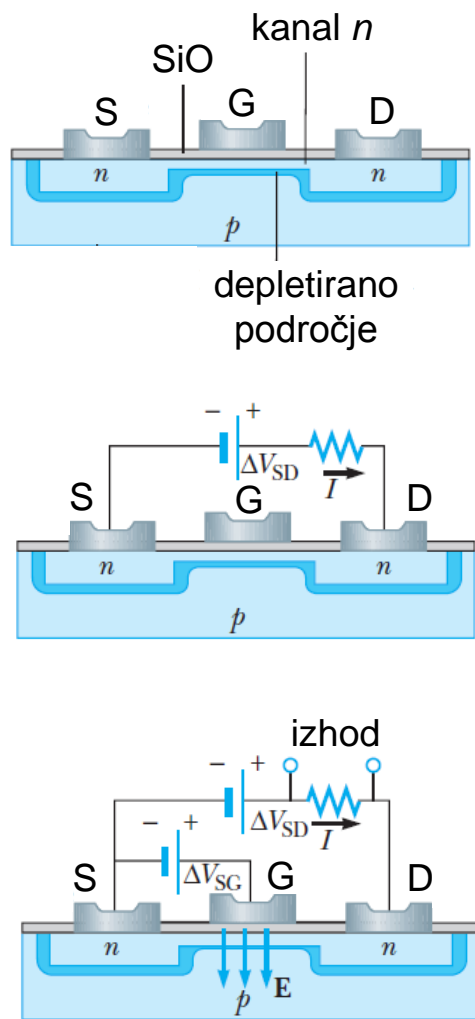

5. Tiskano vezje:



The Nobel Prize in Physics 2000



Zhores I. Alferov
Prize share: 1/4



Herbert Kroemer
Prize share: 1/4



Jack S. Kilby
Prize share: 1/2

The Nobel Prize in Physics 2000 was awarded "for basic work on information and communication technology" with one half jointly to Zhores I. Alferov and Herbert Kroemer "for developing semiconductor heterostructures used in high-speed- and optoelectronics" and the other half to Jack S. Kilby "for his part in the invention of the integrated circuit".

Vir: internet; povzeto po Serway, Moses & Moyer, Modern Physics, Thomson Learning, 2005

9.8 Superprevodnost

➤ Ohmov zakon: $U = IR$

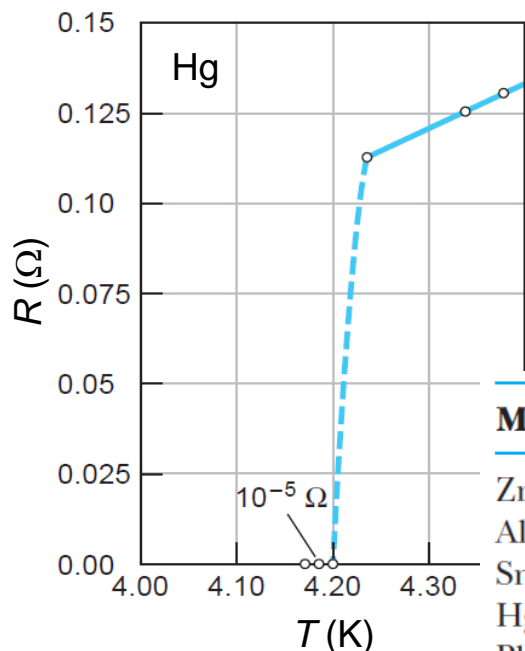

Material	T_c (K)
Zn	0.88
Al	1.19
Sn	3.72
Hg	4.15
Pb	7.18
Nb	9.46
Nb ₃ Sn	18.05
Nb ₃ Ge	23.2
YBa ₂ Cu ₃ O ₇	92
Bi-Sr-Ca-Cu-O	105
Tl-Ba-Ca-Cu-O	125
HgBa ₂ Ca ₂ Cu ₃ O ₈	134

The Nobel Prize in Physics 1913



Heike Kamerlingh Onnes
Prize share: 1/1

The Nobel Prize in Physics 1913 was awarded to Heike Kamerlingh Onnes *"for his investigations on the properties of matter at low temperatures which led, inter alia, to the production of liquid helium"*.

SIMULACIJA

Vir: internet; povzeto po Serway, Moses & Moyer, Modern Physics, Thomson Learning, 2005; Tipler & Llewellyn, Modern Physics, W. H. Freeman and Company, 2012

9.8 Superprevodnost

- Meissnerjev efekt: levitacija

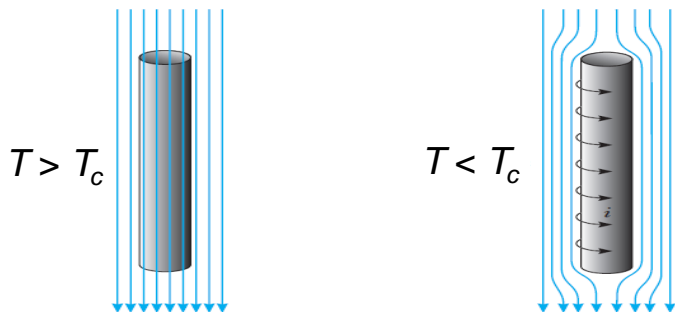

- Teorija BCS:
Cooperjevi pari

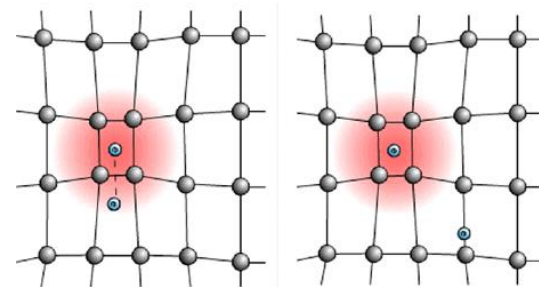

- Kritično polje:

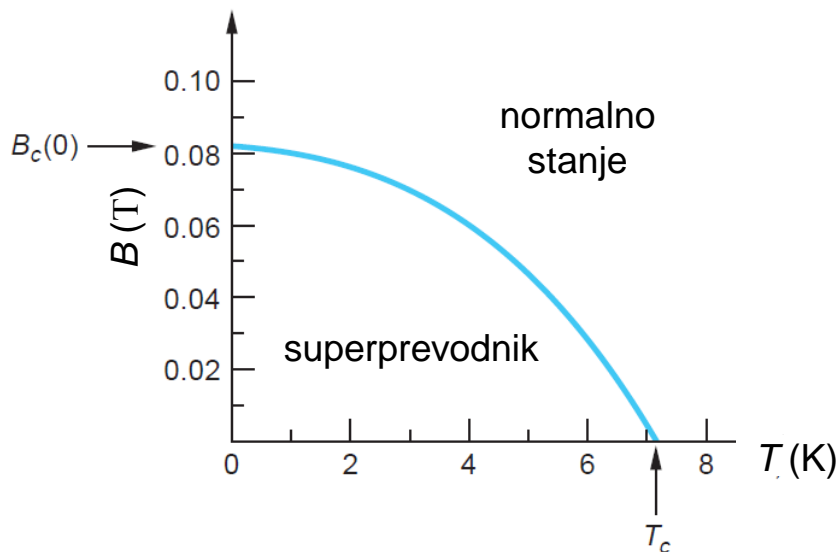

SIMULACIJA

Vir: internet; Tipler & Llewellyn, Modern Physics, W. H. Freeman and Company, 2012

The Nobel Prize in Physics 1972



John Bardeen
Prize share: 1/3



Leon Neil Cooper
Prize share: 1/3



John Robert Schrieffer
Prize share: 1/3

The Nobel Prize in Physics 1972 was awarded jointly to John Bardeen, Leon Neil Cooper and John Robert Schrieffer "for their jointly developed theory of superconductivity, usually called the BCS-theory".

9.8 Superprevodnost

- Visokotemperaturna superprevodnost: keramika

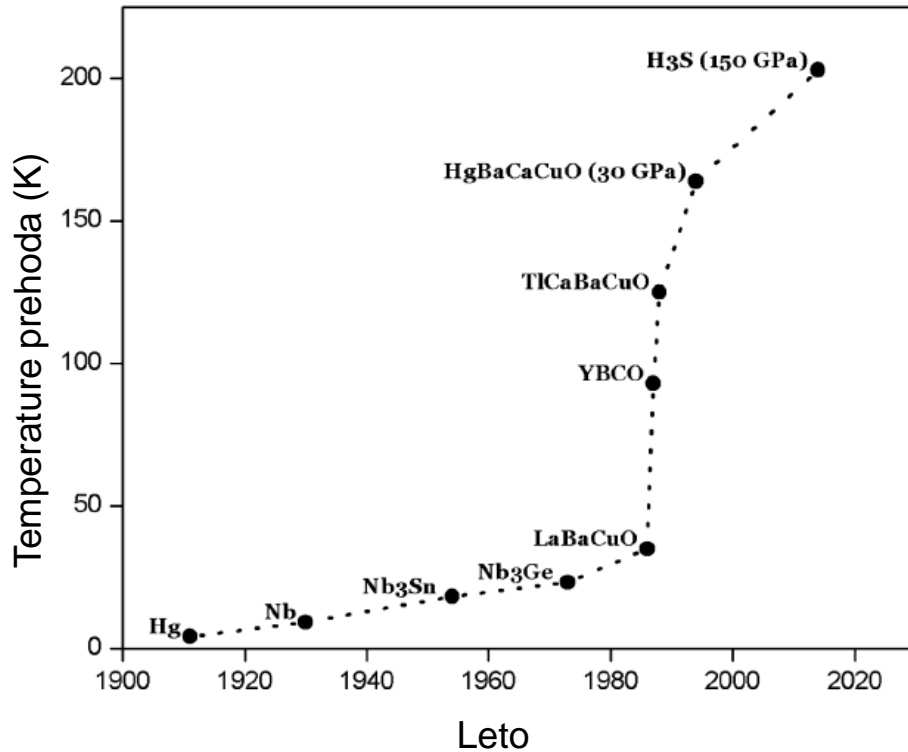

Vir: internet

The Nobel Prize in Physics 1987



J. Georg Bednorz
Prize share: 1/2



K. Alexander Müller
Prize share: 1/2

The Nobel Prize in Physics 1987 was awarded jointly to J. Georg Bednorz and K. Alexander Müller *"for their important breakthrough in the discovery of superconductivity in ceramic materials"*

9.8 Superprevodnost

➤ Uporabnost:

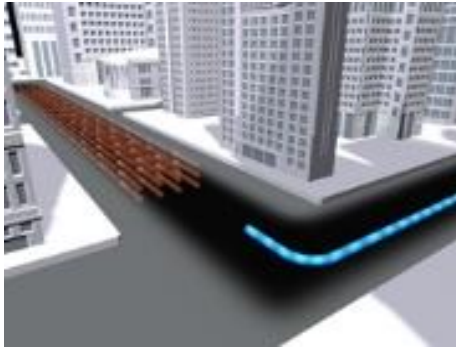

PRENOS EL. ENERGIJE



PREMIKANJE BREZ TRENJA



SUPERPREVODNI MAGNETI



SQUID MAGNETOMETER

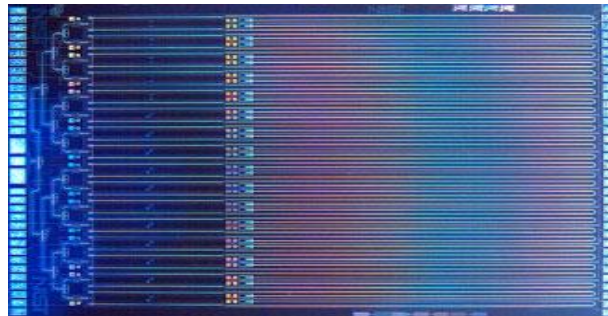

OBČUTLJIVI DETEKTORJI DELCEV

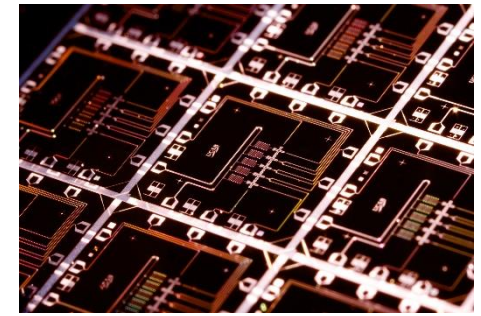

KVANTNO RAČUNALNIŠTVO

Vir: internet



MODERNA FIZIKA

Jedrska fizika

10.1 Lastnosti jeder

- Prelomnice v jedrski fiziki:
 - l. 1896: odkritje radioaktivnosti - rojstvo jedrske fizike (Becquerel)
 - l. 1898: izolacija radija (zakonca Curie)
 - l. 1911: odkritje jedra (Rutherford)

The Nobel Prize in Chemistry 1908



Ernest Rutherford
Prize share: 1/1

The Nobel Prize in Chemistry 1908 was awarded to Ernest Rutherford *"for his investigations into the disintegration of the elements, and the chemistry of radioactive substances"*.

Vir: internet

The Nobel Prize in Physics 1903



Antoine Henri Becquerel
Prize share: 1/2



Pierre Curie
Prize share: 1/4



Marie Curie, née Skłodowska
Prize share: 1/4

The Nobel Prize in Physics 1903 was divided, one half awarded to Antoine Henri Becquerel *"in recognition of the extraordinary services he has rendered by his discovery of spontaneous radioactivity"*, the other half jointly to Pierre Curie and Marie Curie, née Skłodowska *"in recognition of the extraordinary services they have rendered by their joint researches on the radiation phenomena discovered by Professor Henri Becquerel"*.



10.1 Lastnosti jeder

- Prelomnice v jedrski fiziki:
 - I. 1930: odkritje jedrskih reakcij (Cockcroft & Walton)
 - I. 1932: odkritje nevtrona (Chadwick)

The Nobel Prize in Physics 1935



James Chadwick
Prize share: 1/1

The Nobel Prize in Physics 1935 was awarded to James Chadwick *"for the discovery of the neutron"*.

Vir: internet

The Nobel Prize in Physics 1951



**Sir John Douglas
Cockcroft**
Prize share: 1/2



**Ernest Thomas
Sinton Walton**
Prize share: 1/2

The Nobel Prize in Physics 1951 was awarded jointly to Sir John Douglas Cockcroft and Ernest Thomas Sinton Walton *"for their pioneer work on the transmutation of atomic nuclei by artificially accelerated atomic particles"*

10.1 Lastnosti jeder

➤ Prelomnice v jedrski fiziki:

- l. 1933: odkritje umetne radioaktivnosti (Irène & Frédéric Joliot-Curie)
- l. 1938: odkritje jedrske fisije (Meitner, Hahn, Strassmann)
- l. 1942: razvoj prvega jedrskega reaktorja (Fermi)

The Nobel Prize in Physics 1938



Enrico Fermi
Prize share: 1/1

The Nobel Prize in Physics 1938 was awarded to Enrico Fermi *"for his demonstrations of the existence of new radioactive elements produced by neutron irradiation, and for his related discovery of nuclear reactions brought about by slow neutrons"*.

Vir: internet; povzeto po Serway, Moses & Moyer, Modern Physics, Thomson Learning, 2005

The Nobel Prize in Chemistry 1935



Frédéric Joliot
Prize share: 1/2



Irène Joliot-Curie
Prize share: 1/2

The Nobel Prize in Chemistry 1935 was awarded jointly to Frédéric Joliot and Irène Joliot-Curie *"in recognition of their synthesis of new radioactive elements"*

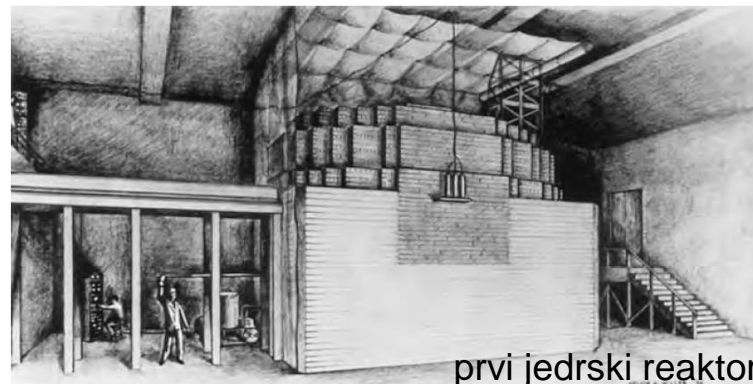

prvi jedrski reaktor

10.1 Lastnosti jeder

➤ Sestava jeder (nukleoni): ${}^A_Z X$

- vrstno (atomsko) število (protoni): Z
- nevtronsko število (nevtroni): N
- masno število (nukleoni): $A = Z + N$

➤ Naboj jeder: Ze_0

➤ Masa:

$$M({}^A_Z X) \neq Zm_p + (A - Z)m_n + Zm_e$$

$$1u \equiv \frac{1}{12} \frac{M({}^{12}\text{C})}{N_A} = 1,66 \times 10^{-27} \text{ kg}$$

$$= 931,49 \text{ MeV}/c^2$$

➤ Velikost jeder: Rutherfordovo sipanje

$$r = r_0 A^{1/3} \quad (\text{kapljična narava})$$

$$r_0 = 1,2 \text{ fm}$$

Izotopi:



vodik
(99.98%)



devterij
(0.02%)



tritij

masa

delec	kg	u	MeV/c ²
proton	$1.672\ 623 \times 10^{-27}$	1.007 276	938.272 3
neutron	$1.674\ 929 \times 10^{-27}$	1.008 665	939.565 6
elektron	$9.109\ 390 \times 10^{-31}$	$5.48\ 579\ 9 \times 10^{-4}$	0.510 999 1

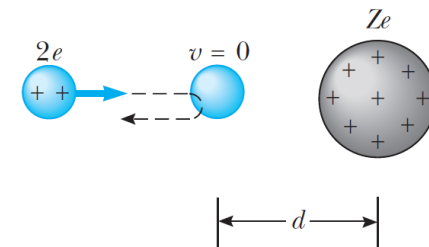

10.1 Lastnosti jeder

➤ Stabilnost jeder:

magična števila: 2, 8, 20, 28, 50, 82, 126
(lupinska struktura)

➤ Vezavna energija:

$$E_v = [m({}_Z^A X) - Zm({}_1^1 H) - (A - Z)m_n] c^2$$

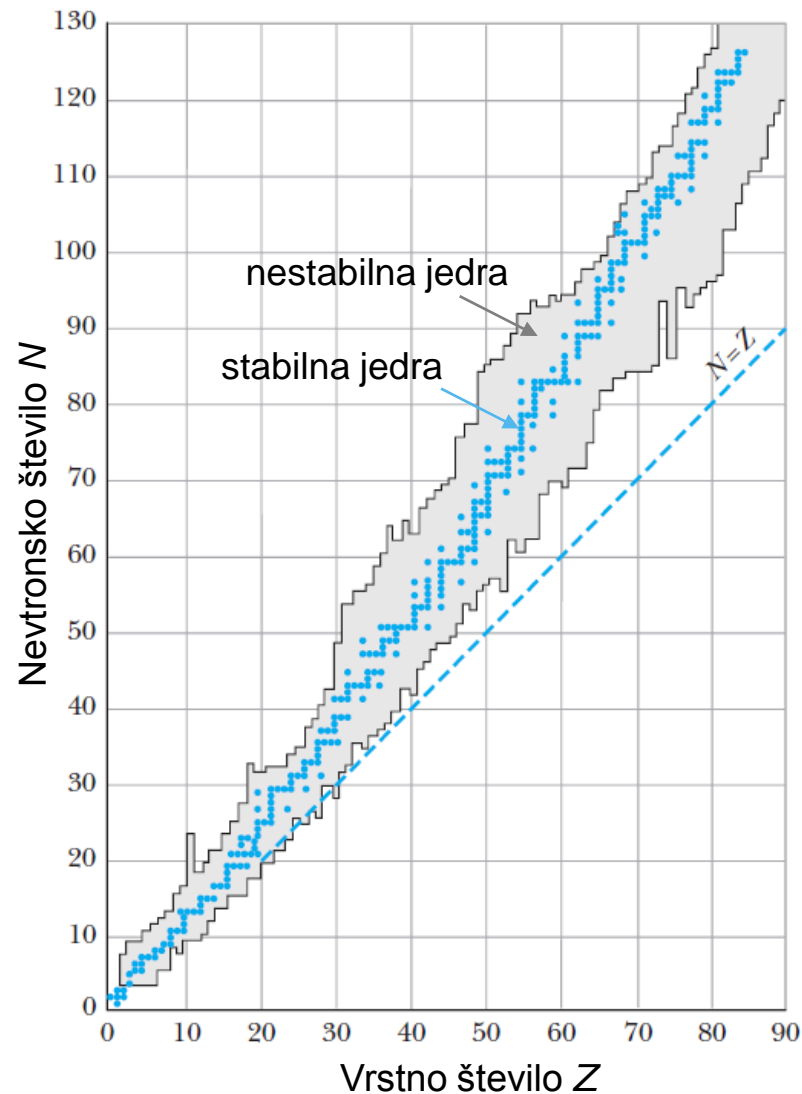
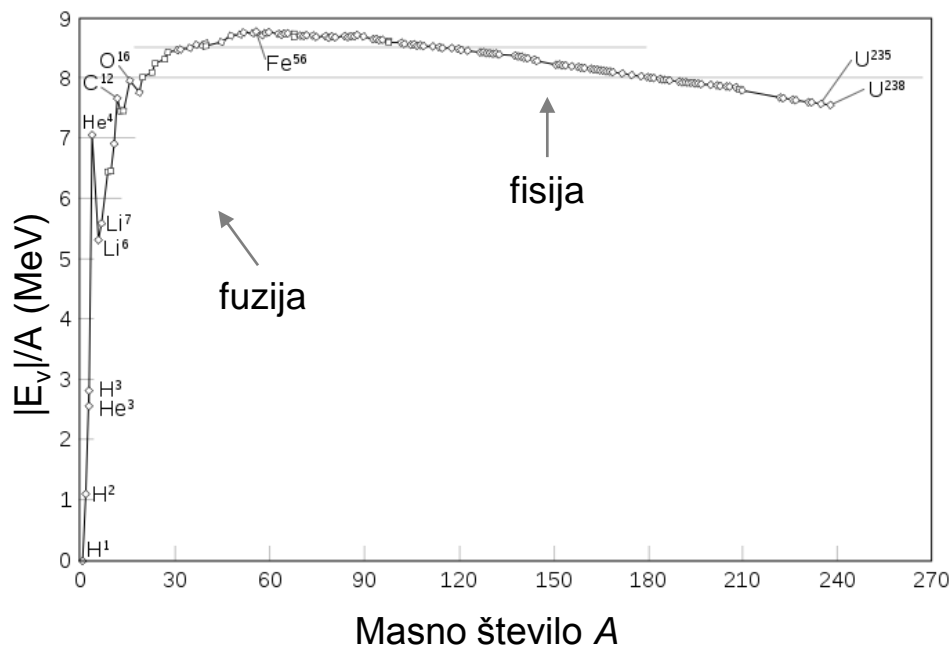

Vir: internet; povzeto po Serway, Moses & Moyer, Modern Physics, Thomson Learning, 2005

10.1 Lastnosti jeder

➤ Jedrska sila in potencial:

- kratek dosež (nekaj fm)
- sila neodvisna od naboja nukleona

The Nobel Prize in Physics 1949



Hideki Yukawa
Prize share: 1/1

The Nobel Prize in Physics 1949 was awarded to Hideki Yukawa "for his prediction of the existence of mesons on the basis of theoretical work on nuclear forces".

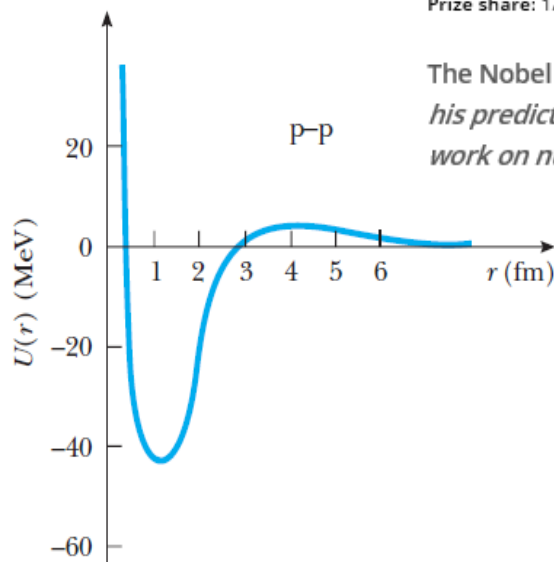
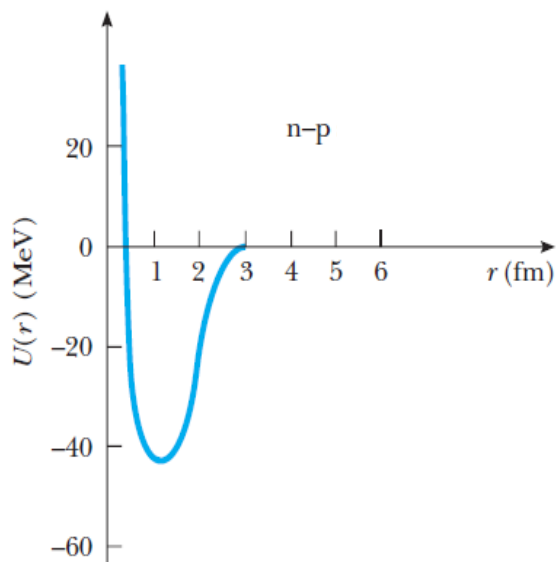

model izmenjave delcev (mezonov)

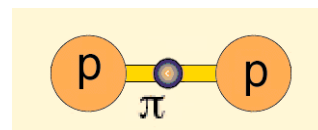

Vir: internet; povzeto po Serway, Moses & Moyer, Modern Physics, Thomson Learning, 2005



10.2 Fizikalni modeli jadra

1. Kapljični model (Weiszäcker, I. 1935):

➤ Semiempirična masna formula:

$$E_v = -w_0A + w_1A^{2/3} + w_2\frac{Z^2}{A^{1/3}} + w_3\frac{(A - 2Z)^2}{A} + w_4\frac{\delta_{ZN}}{A^{3/4}}$$

$$w_0 = 15,7 \text{ MeV}$$

$$w_1 = 17,8 \text{ MeV}$$

$$w_2 = 0,71 \text{ MeV}$$

$$w_3 = 23,6 \text{ MeV}$$

$$w_4 = 33,5 \text{ MeV}$$

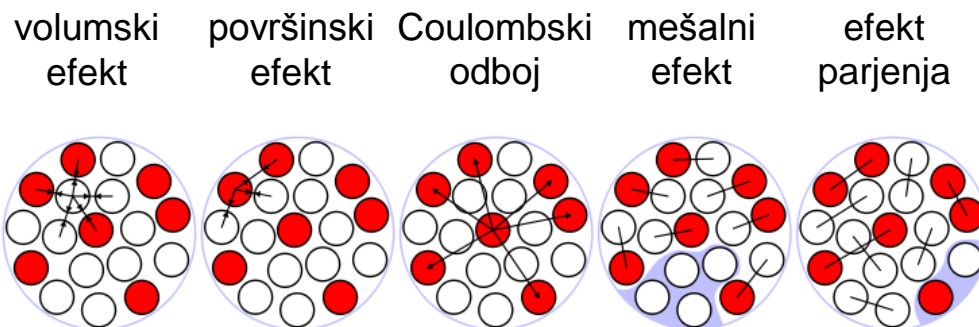

➤ Jedrski razpad: Coulombski odboj vs. površinska energija

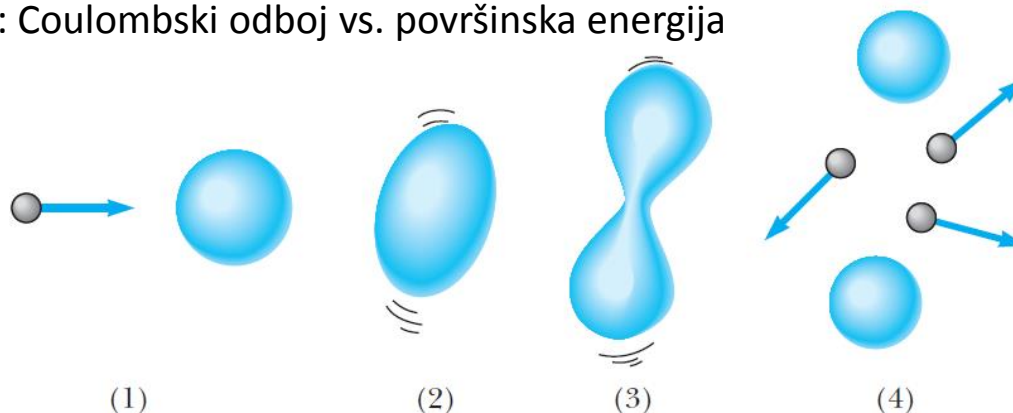

Vir: internet; povzeto po Serway, Moses & Moyer, Modern Physics, Thomson Learning, 2005

10.2 Fizikalni modeli jedra

➤ Dolina stabilnosti:

$$\frac{N}{Z} \approx 1 + \frac{w_2}{2w_3} A^{2/3}$$

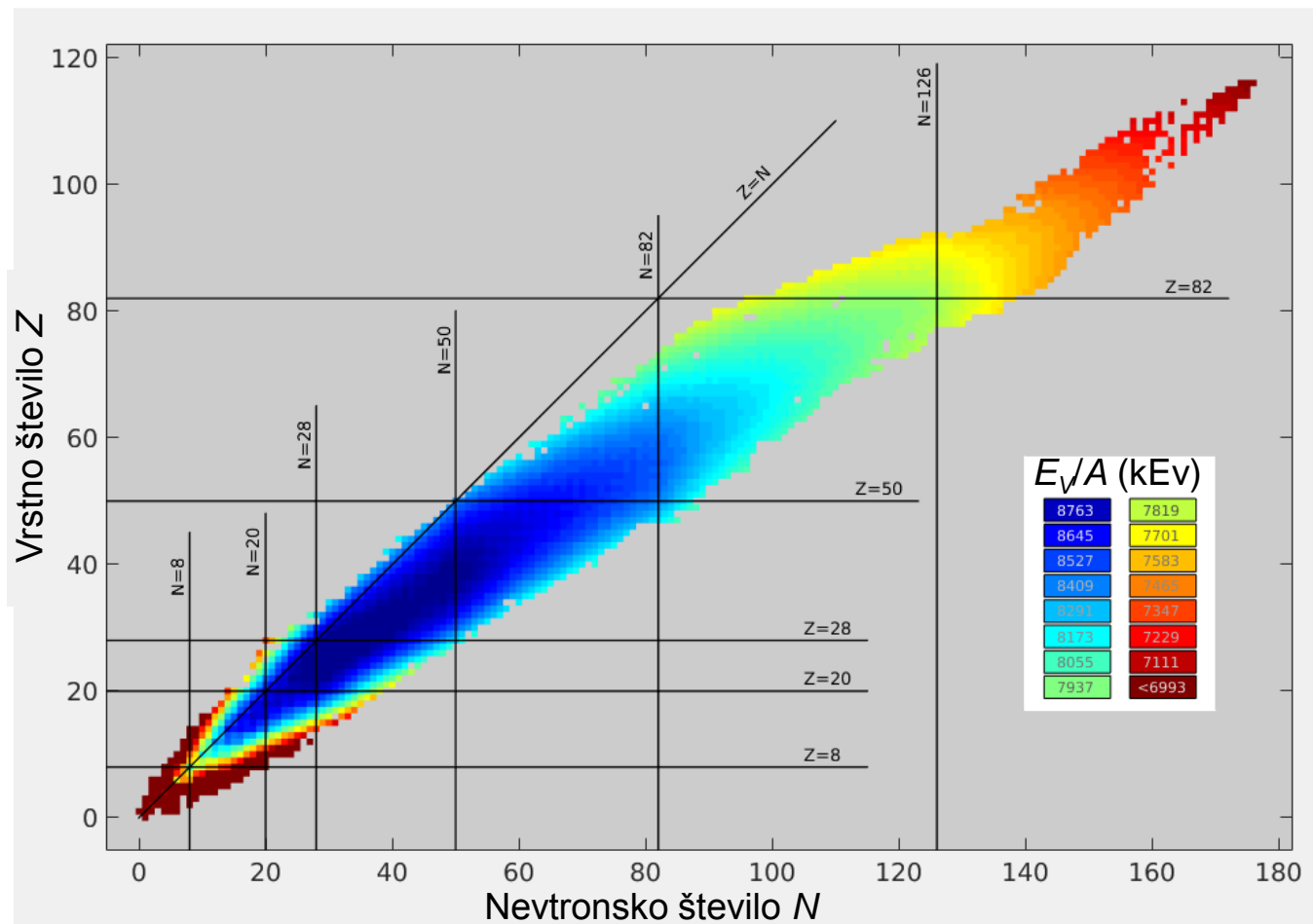

Vir: internet

10.2 Fizikalni modeli jedra

2. Lupinski model (Goeppert-Mayer, Jensen):

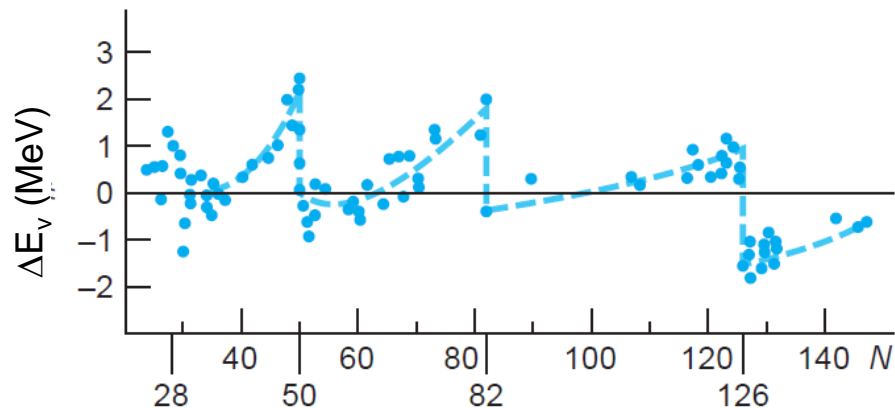

➤ Magična števila: 2, 8, 20, 28, 50, 82, 126

➤ Analogija z lupinskim modelom elektronov v atomu:

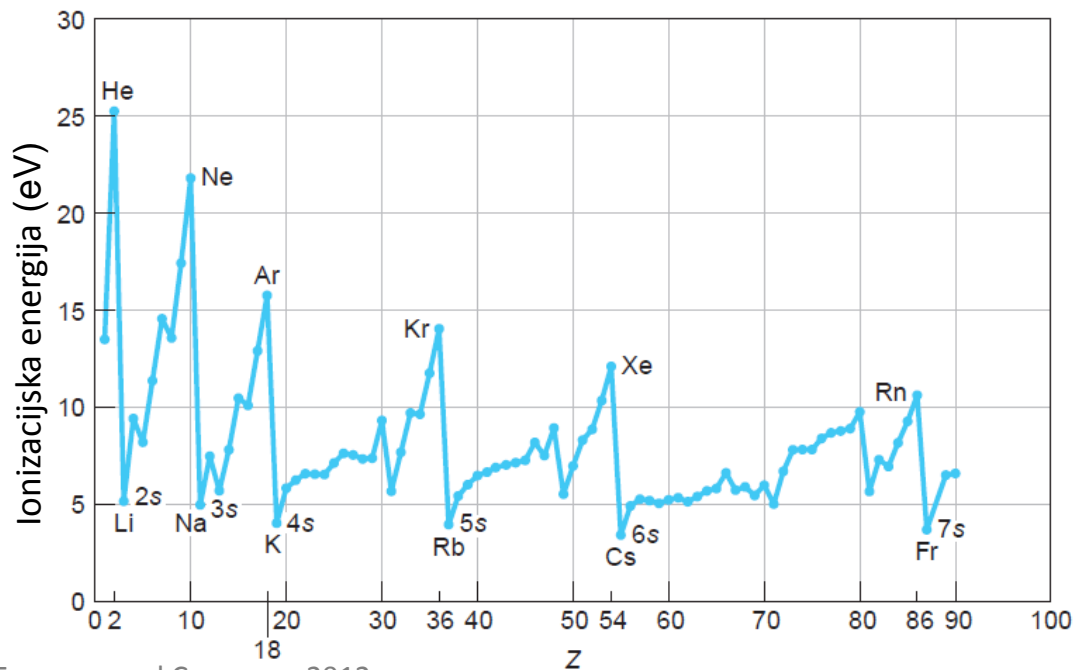

Vir: povzeto po Tipler & Llewellyn, Modern Physics, W. H. Freeman and Company, 2012



10.2 Fizikalni modeli jedra

- Neodvisni delci: Paulijevo izključitveno načelo

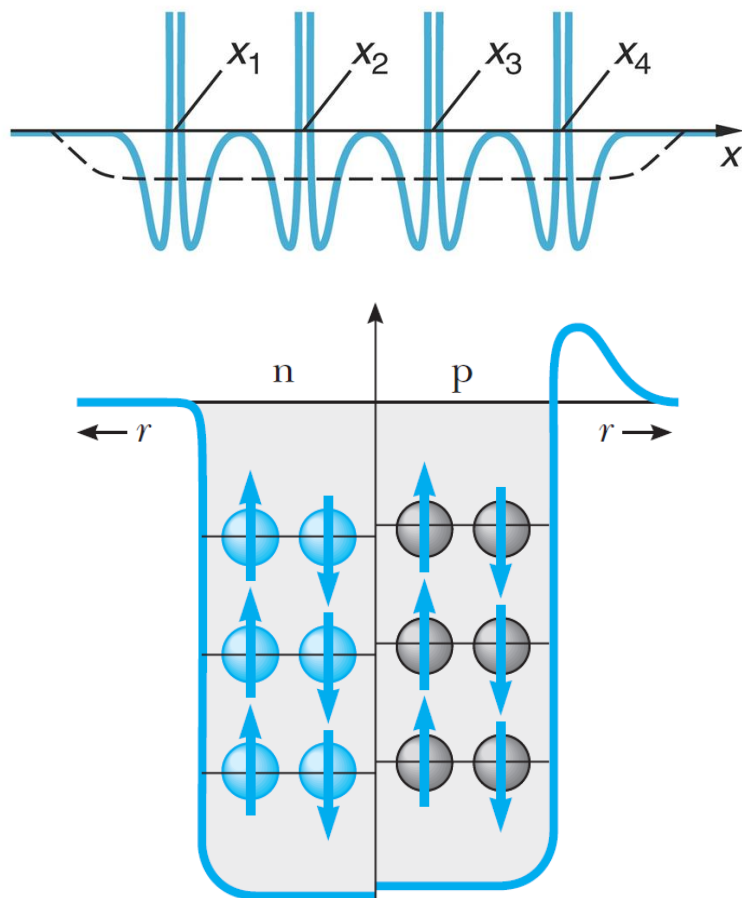

The Nobel Prize in Physics 1963



Eugene Paul Wigner
Prize share: 1/2



Maria Goeppert Mayer
Prize share: 1/4



J. Hans D. Jensen
Prize share: 1/4

The Nobel Prize in Physics 1963 was divided, one half awarded to Eugene Paul Wigner *"for his contributions to the theory of the atomic nucleus and the elementary particles, particularly through the discovery and application of fundamental symmetry principles"*, the other half jointly to Maria Goeppert Mayer and J. Hans D. Jensen *"for their discoveries concerning nuclear shell structure"*.

Vir: internet; povzeto po Serway, Moses & Moyer, Modern Physics, Thomson Learning, 2005; Tipler & Llewellyn, Modern Physics, W. H. Freeman and Company, 2012

10.2 Fizikalni modeli jadra

- Potencial: 3D harmonski oscilator (HO)

$$E = \hbar\omega \left(n_x + n_y + n_z + \frac{3}{2} \right)$$

$$= \hbar\omega \left(n + \frac{1}{2} \right) \quad n = 2n_r + l + 1$$

degeneracija: $n(n + 1)$

- Potencial: Saxon-Woods (SW)

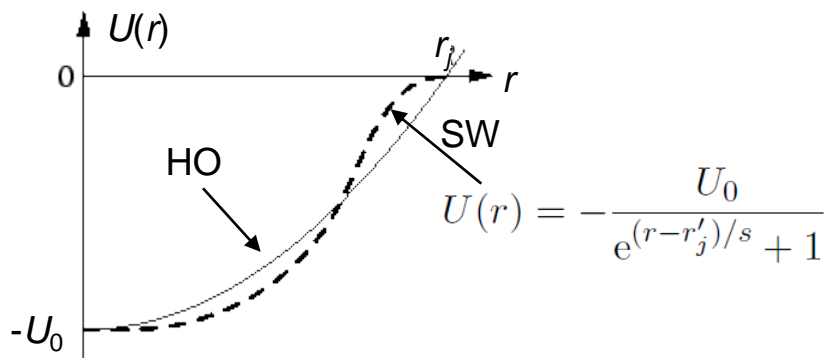

- Sklopitev l_s : $E_{l_s} = -\eta \vec{l} \cdot \vec{s}$

$$E(I = l + \frac{1}{2}) < E(I = l - \frac{1}{2})$$

degeneracija: $2I + 1$

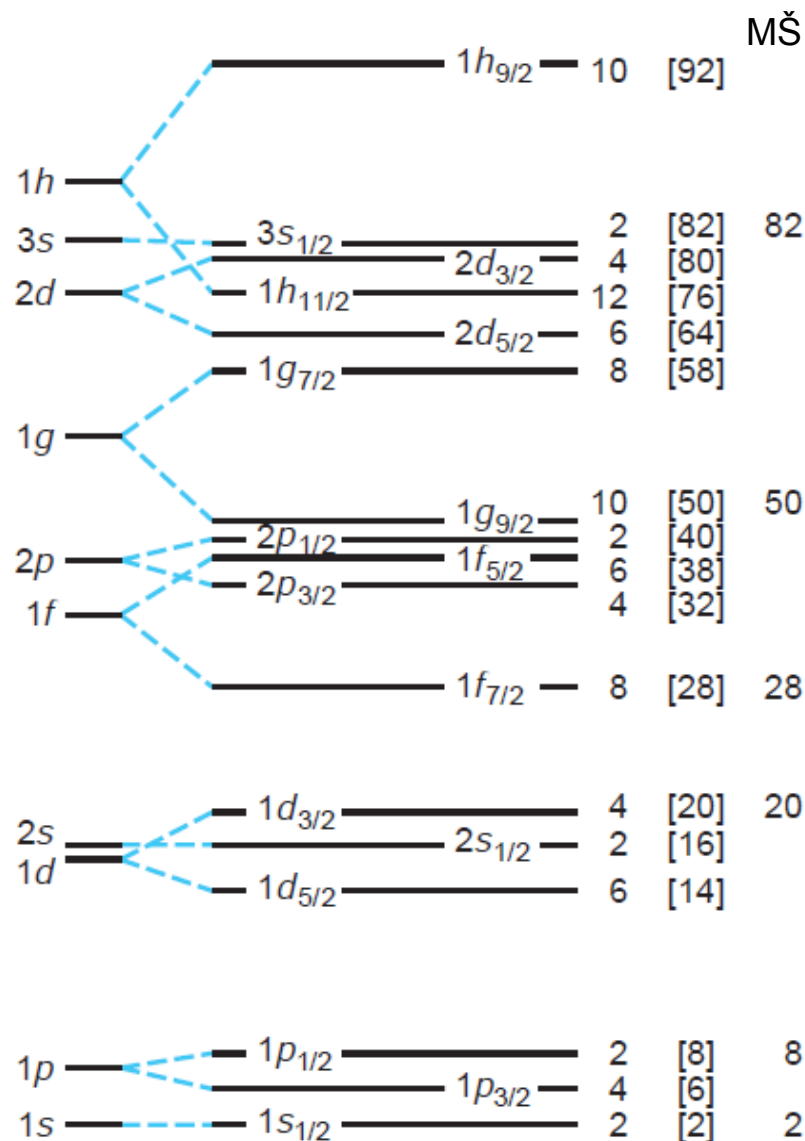

Vir: internet; povzeto po Tipler & Llevellyn, Modern Physics, W. H. Freeman and Company, 2012

10.3 Jedrski magnetizem

- Magnetni moment jedra: $\vec{\mu} = \frac{g\mu_j}{\hbar} \vec{J} = \gamma \vec{J}$ $\vec{J} = \hbar \vec{I}$
 $\mu_z = \gamma J_z$
- Jedrski magneton: $\mu_j = \frac{e_0 \hbar}{2m_p} = 5,05 \times 10^{-27} \text{ Am}^2$
- Giromagnetno razmerje: γ
- Kvantizacija momenta: $\mu_z = \gamma \hbar m$
- Spin jedra (lupinski model):

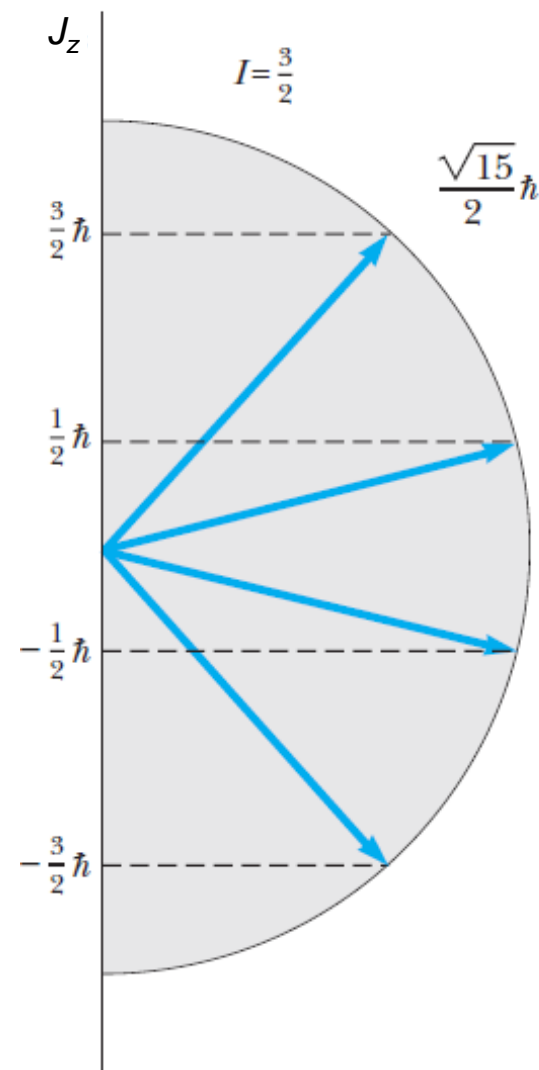
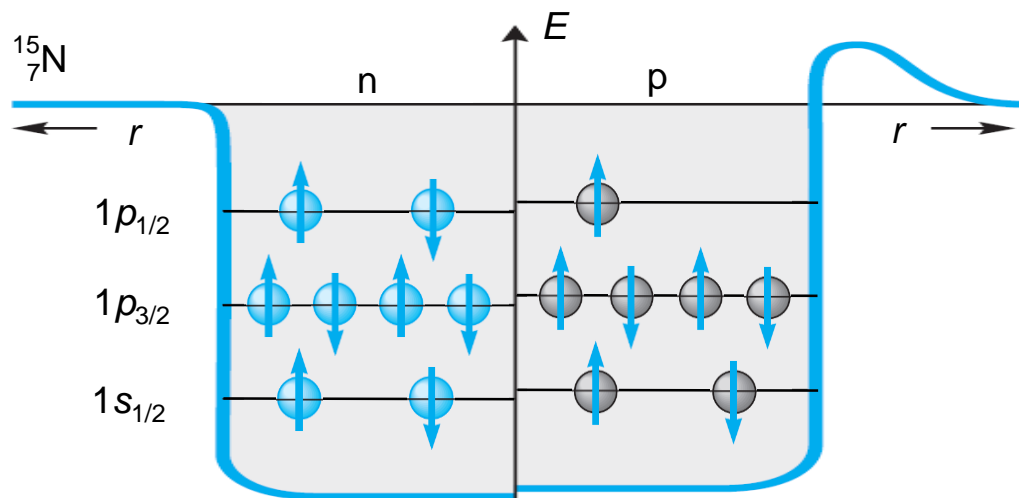

Vir: povzeto po Serway, Moses & Moyer, Modern Physics, Thomson Learning, 2005

10.3 Jedrski magnetizem

➤ Jedrska magnetna resonanca (NMR):

$$\Delta E = \gamma \hbar B_0 = h\nu_L$$

The Nobel Prize in Physics 1952



Felix Bloch
Prize share: 1/2



Edward Mills Purcell
Prize share: 1/2

The Nobel Prize in Physics 1952 was awarded jointly to Felix Bloch and Edward Mills Purcell *"for their development of new methods for nuclear magnetic precision measurements and discoveries in connection therewith"*

Vir: internet; povzeto po Serway, Moses & Moyer, Modern Physics, Thomson Learning, 2005

The Nobel Prize in Physics 1944



Isidor Isaac Rabi
Prize share: 1/1

The Nobel Prize in Physics 1944 was awarded to Isidor Isaac Rabi *"for his resonance method for recording the magnetic properties of atomic nuclei"*.

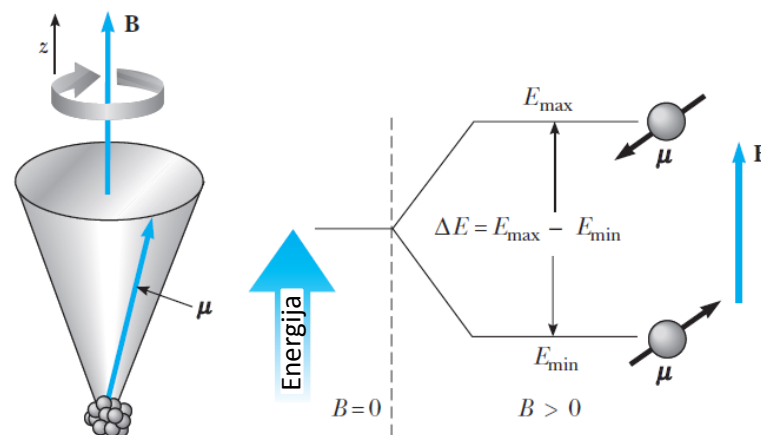

10.3 Jedrski magnetizem

- Jedrska magnetna resonanca (NMR): eksperiment

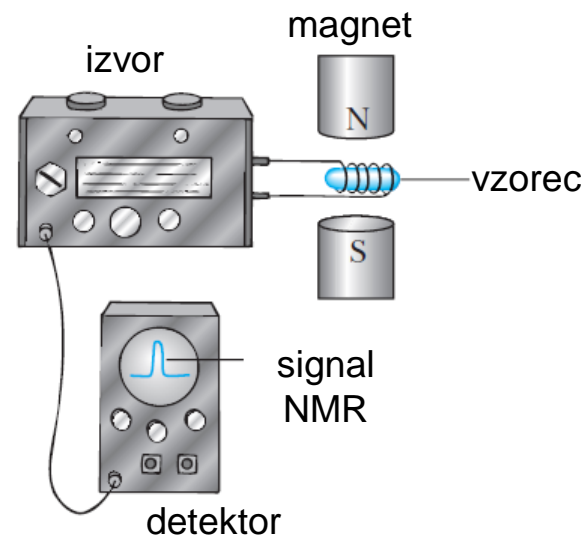
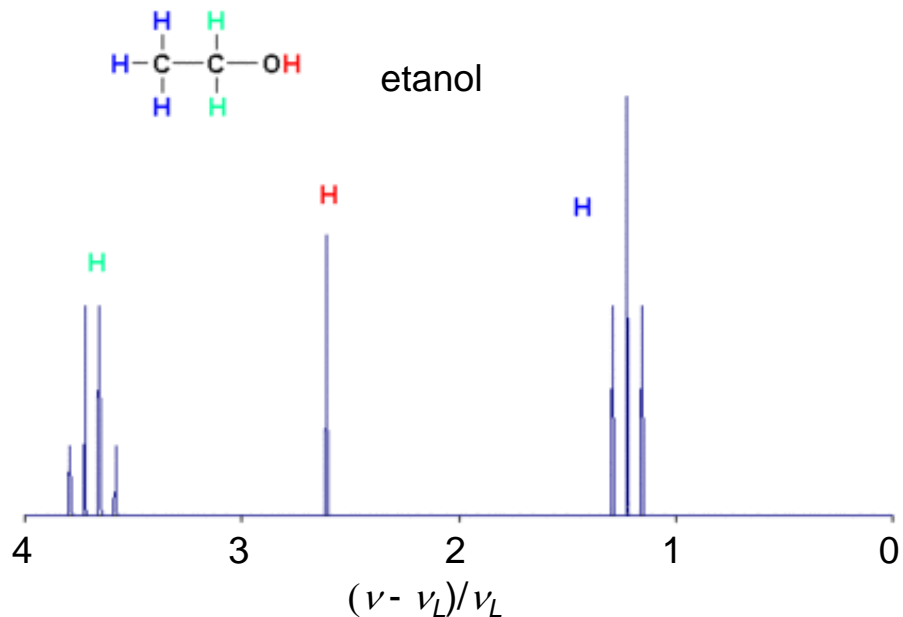

- Slikanje (MRI):

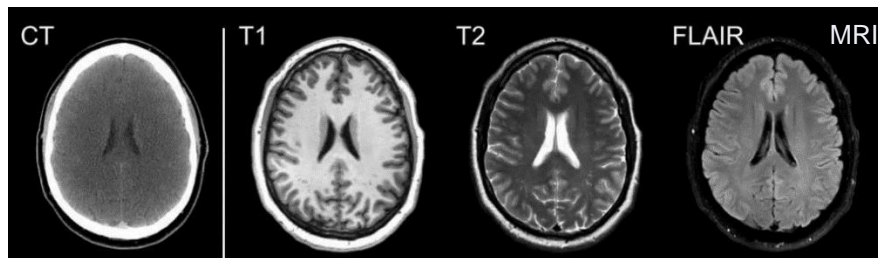

SIMULACIJA

Vir: internet; povzeto po Serway, Moses & Moyer, Modern Physics, Thomson Learning, 2005

10.4 Radioaktivnost in razpadni procesi

- Antoine Henri Becquerel (l. 1896): $K_2(UO_2)(SO_4)_2$

I will insist particularly upon the following fact, which seems to me quite important and beyond the phenomena which one could expect to observe:

The same crystalline crusts [of potassium uranyl sulfate], arranged the same way with respect to the photographic plates, in the same conditions and through the same screens, but sheltered from the excitation of incident rays and kept in darkness, still produce the same photographic images.

- Tipi sevanja:

- sevanje α
- sevanje β
- sevanje γ

- Razpadni zakon: $N(t) = N_0 e^{-\lambda t} = N_0 e^{-t/\tau}$

$$\tau = \frac{1}{\lambda} \quad t_{1/2} = \ln 2 \cdot \tau$$

- Aktivnost: $A(t) = \left| \frac{dN(t)}{dt} \right| = \lambda N_0 e^{-t/\tau}$

SIMULACIJA

Vir: internet; povzeto po Serway, Moses & Moyer, Modern Physics, Thomson Learning, 2005

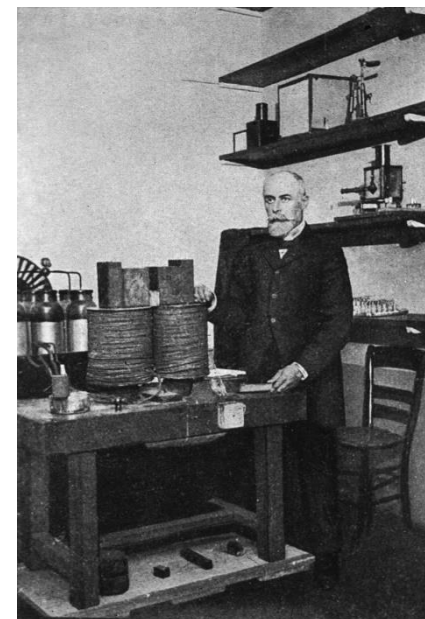
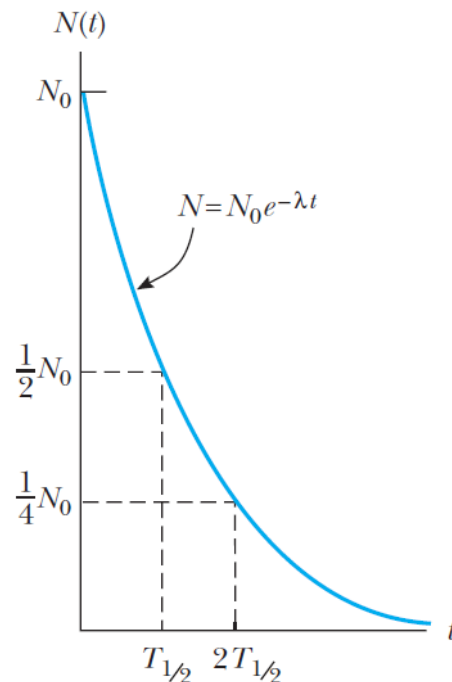

Antoine Henri Becquerel

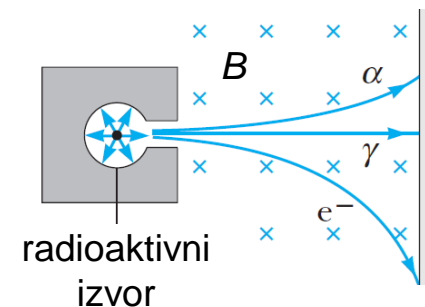

10.4 Radioaktivnost in razpadni procesi

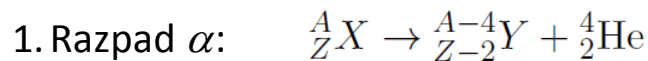

➤ Energija: $Q = (m_X - m_Y - m_\alpha)c^2$

$$W_k^\alpha = \frac{m_Y}{m_Y + m_\alpha} Q$$

➤ Tuneliranje: Geiger-Nuttalova enačba

$$\ln \tau = \frac{a}{\sqrt{W_k^\alpha}} - b$$

$$a = \frac{e_0^2 (Z - 2) \sqrt{2m_r}}{2\epsilon_0 \hbar}$$

$$b = \frac{4e_0}{\hbar} \sqrt{\frac{(Z - 2)m_r r_j}{\pi \epsilon_0}} + \ln \left(\frac{W_k^\alpha}{2m_r r_j^2} \right)^{1/2}$$

$$m_r = \frac{m_Y m_\alpha}{m_Y + m_\alpha}$$

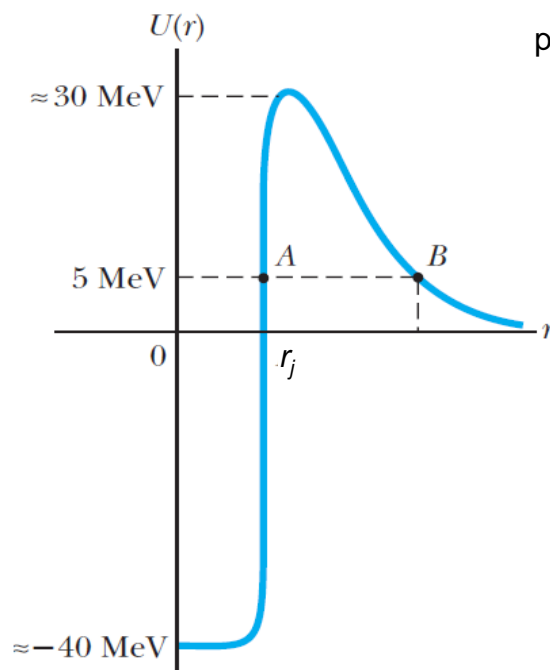
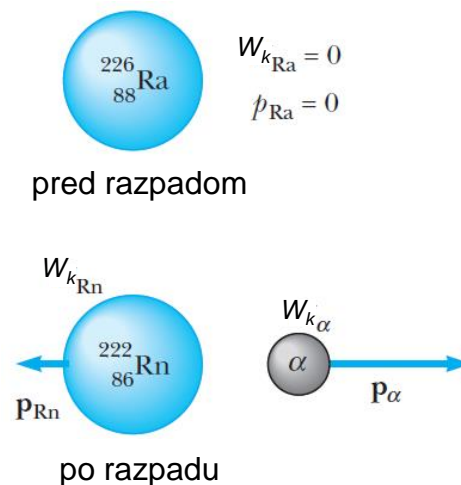

SIMULACIJA

Vir: internet; povzeto po Serway, Moses & Moyer, Modern Physics, Thomson Learning, 2005

10.4 Radioaktivnost in razpadni procesi

2. Razpad β :

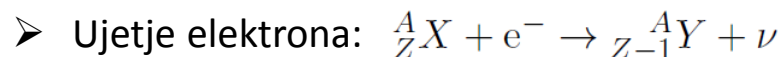
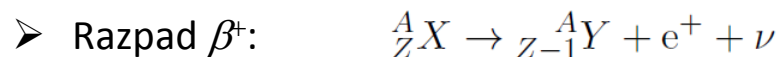
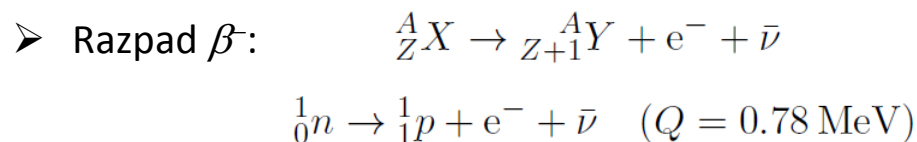
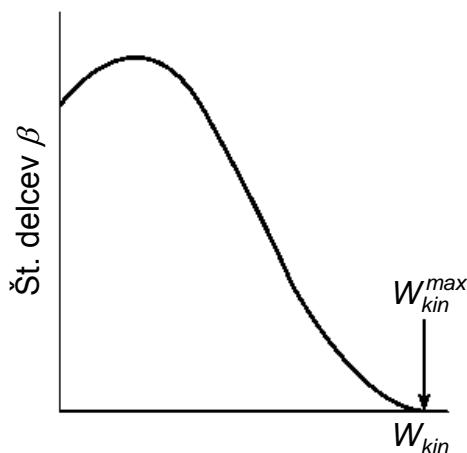

SIMULACIJA

Vir: internet; povzeto po Serway, Moses & Moyer, Modern Physics, Thomson Learning, 2005

The Nobel Prize in Physics 1995



Martin L. Perl
Prize share: 1/2



© University of California Regents
Frederick Reines
Prize share: 1/2

The Nobel Prize in Physics 1995 was awarded "for pioneering experimental contributions to lepton physics" jointly with one half to Martin L. Perl "for the discovery of the tau lepton" and with one half to Frederick Reines "for the detection of the neutrino".

10.4 Radioaktivnost in razpadni procesi

3. Razpad γ : ${}^A_Z X^* \rightarrow {}^A_Z X + \gamma$

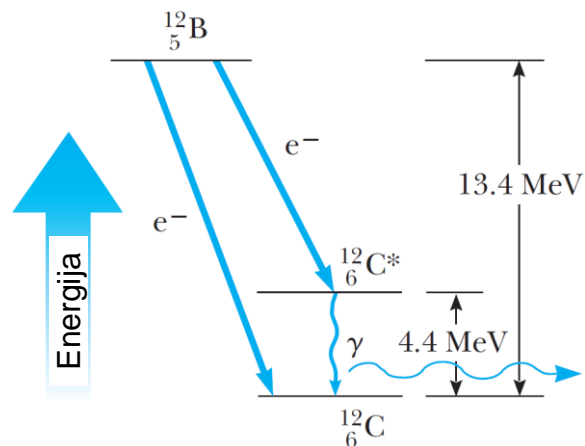

➤ Mössbauerjeva spektroskopija: ${}^{57}\text{Fe}$

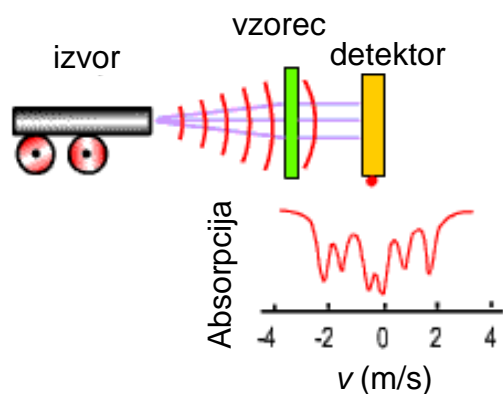

The Nobel Prize in Physics 1961



Robert Hofstadter
Prize share: 1/2



Rudolf Ludwig
Mössbauer
Prize share: 1/2

The Nobel Prize in Physics 1961 was divided equally between Robert Hofstadter *"for his pioneering studies of electron scattering in atomic nuclei and for his thereby achieved discoveries concerning the structure of the nucleons"* and Rudolf Ludwig Mössbauer *"for his researches concerning the resonance absorption of gamma radiation and his discovery in this connection of the effect which bears his name"*.

10.4 Radioaktivnost in razpadni procesi

➤ Razpadni nizi:

1. uranov niz:

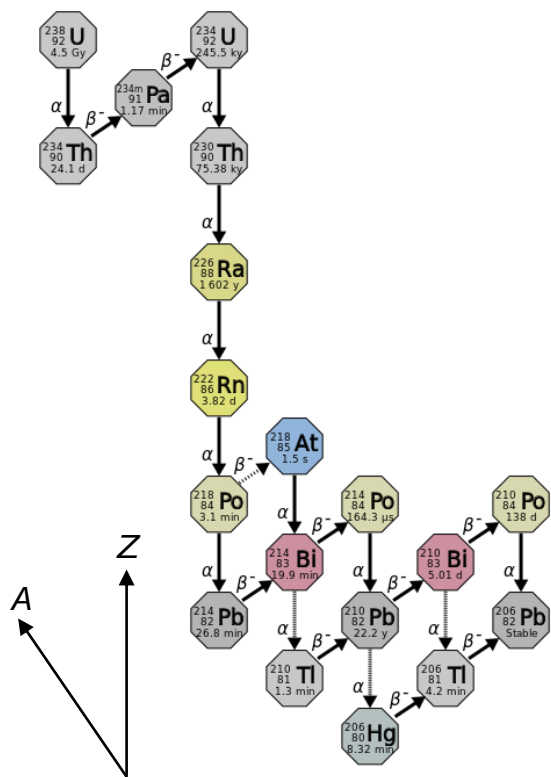

2. aktinijev niz:

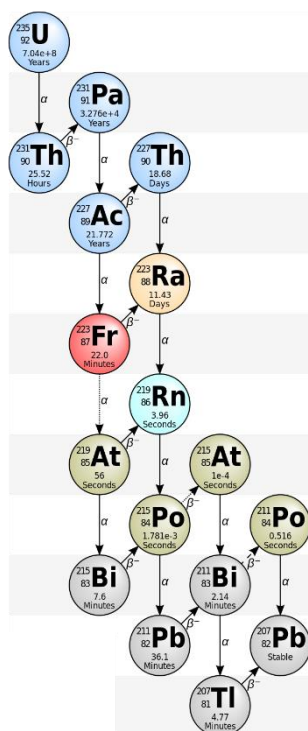

3. torijev niz:

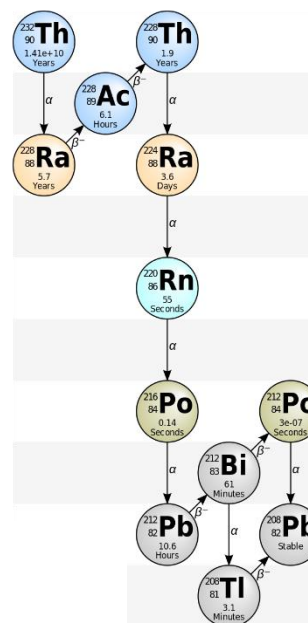

4. neptunijev niz:

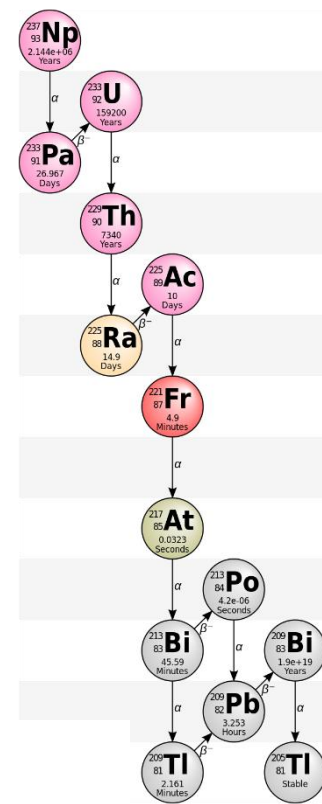

Vir: internet

10.5 Jedrske reakcije

- Cockcroft, Walton (l. 1932):

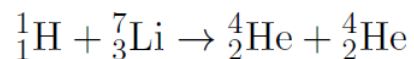

- Jedrska reakcija:

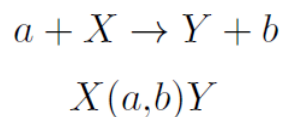

- Ohranitev:

- masnega števila
- naboja
- energije, gibalne količine, vrtilne količine

$$Q = W_{kin}^Y + W_{kin}^b - W_{kin}^X - W_{kin}^a$$
$$= (m_X + m_a - m_Y - m_b)c^2$$

Vir: internet



Walton

Rutherford

Cockcroft

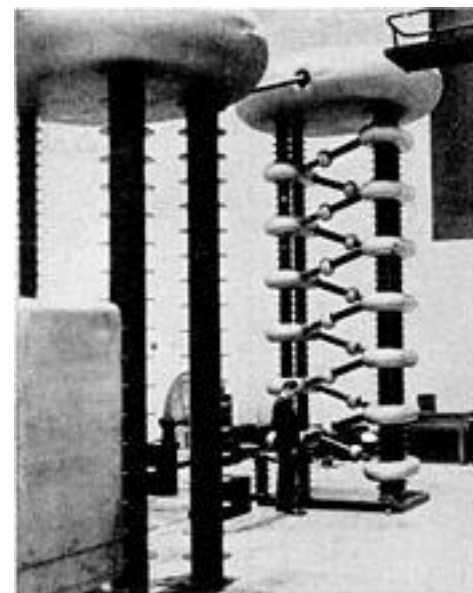

1,2 MV generator
Cockcrofta in Waltona

10.5 Jedrske reakcije

- Število reakcij N_r :

$$\frac{N_r}{N_i} = \frac{\sigma N_j}{S}$$

- Tanka folija:

$$dN_i = -\sigma n_j N_i dx$$

$$j = j_0 e^{-\sigma n_j x}$$

- Siplni presek:

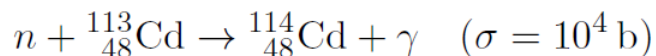
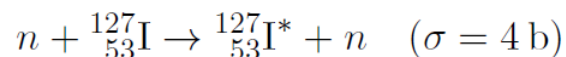
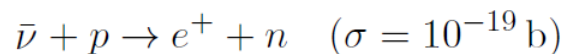

- Diferencialni sipalni presek:

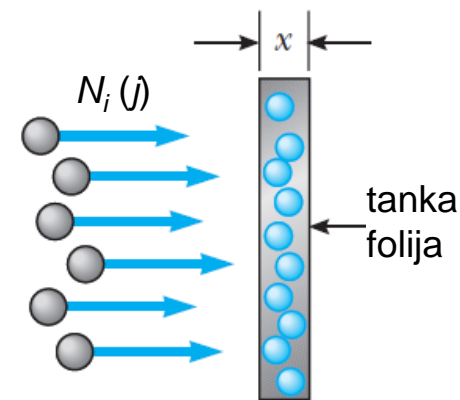
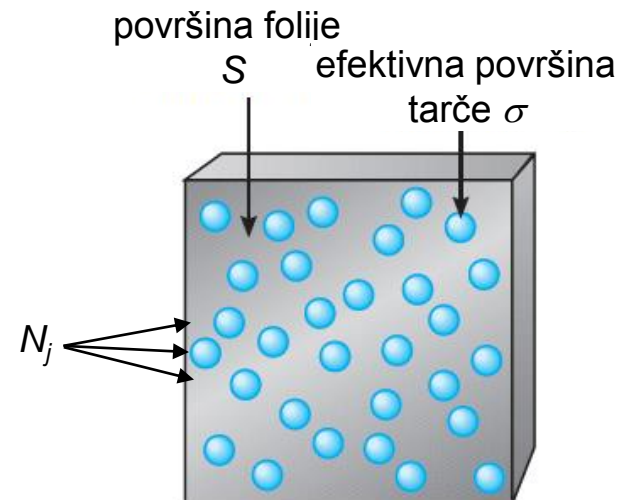
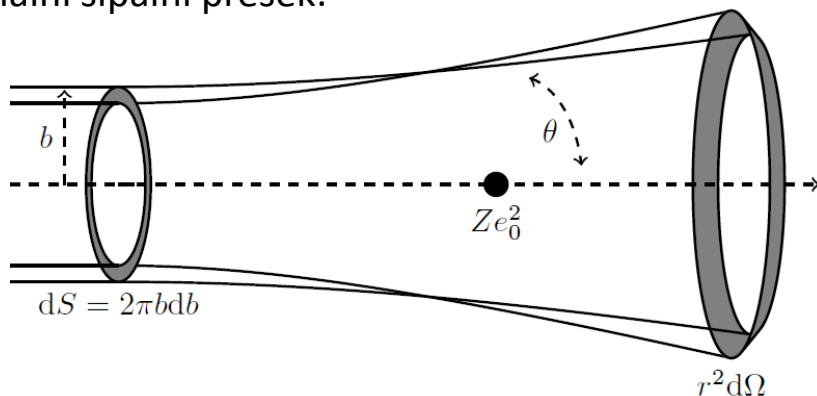

Vir: povzeto po Serway, Moses & Moyer, Modern Physics, Thomson Learning, 2005

10.6 Razcep in zlivanje jeder

➤ Razcep jedra (fisiija):

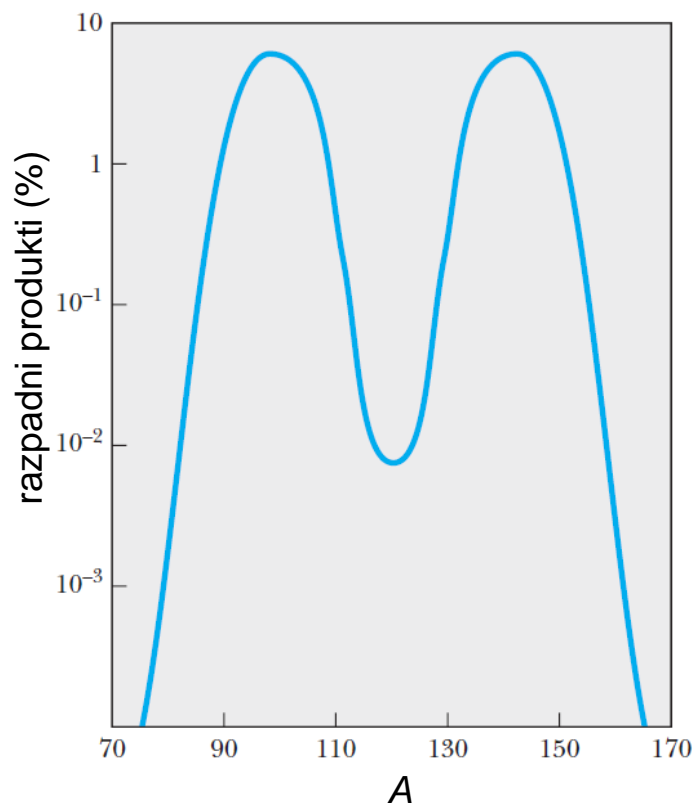
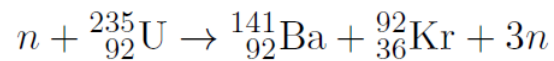

Strassmann

Meitner

Hahn

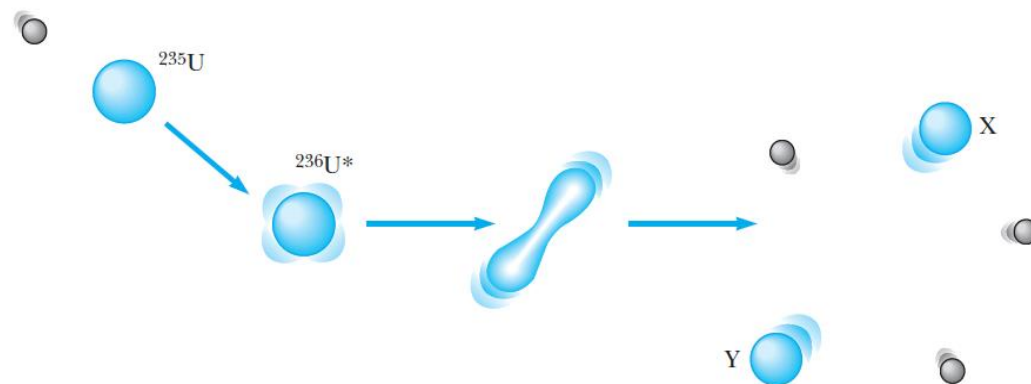

Vir: povzeto po Serway, Moses & Moyer, Modern Physics, Thomson Learning, 2005

10.6 Razcep in zlivanje jeter

➤ Komponente jedrskega reaktorja:

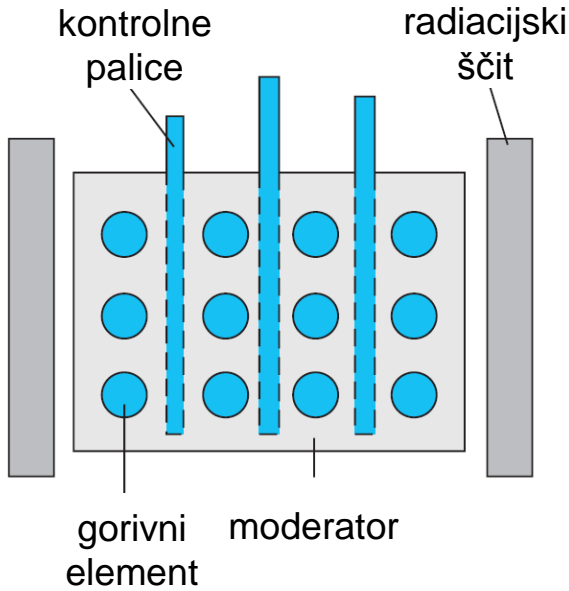

➤ Delovanje reaktorja:

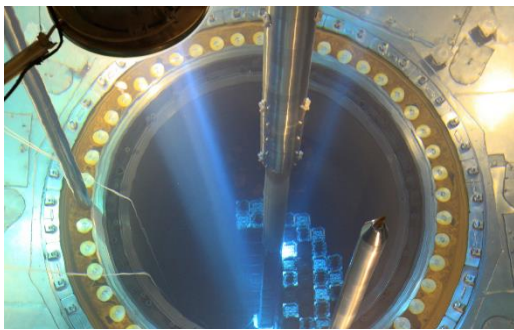
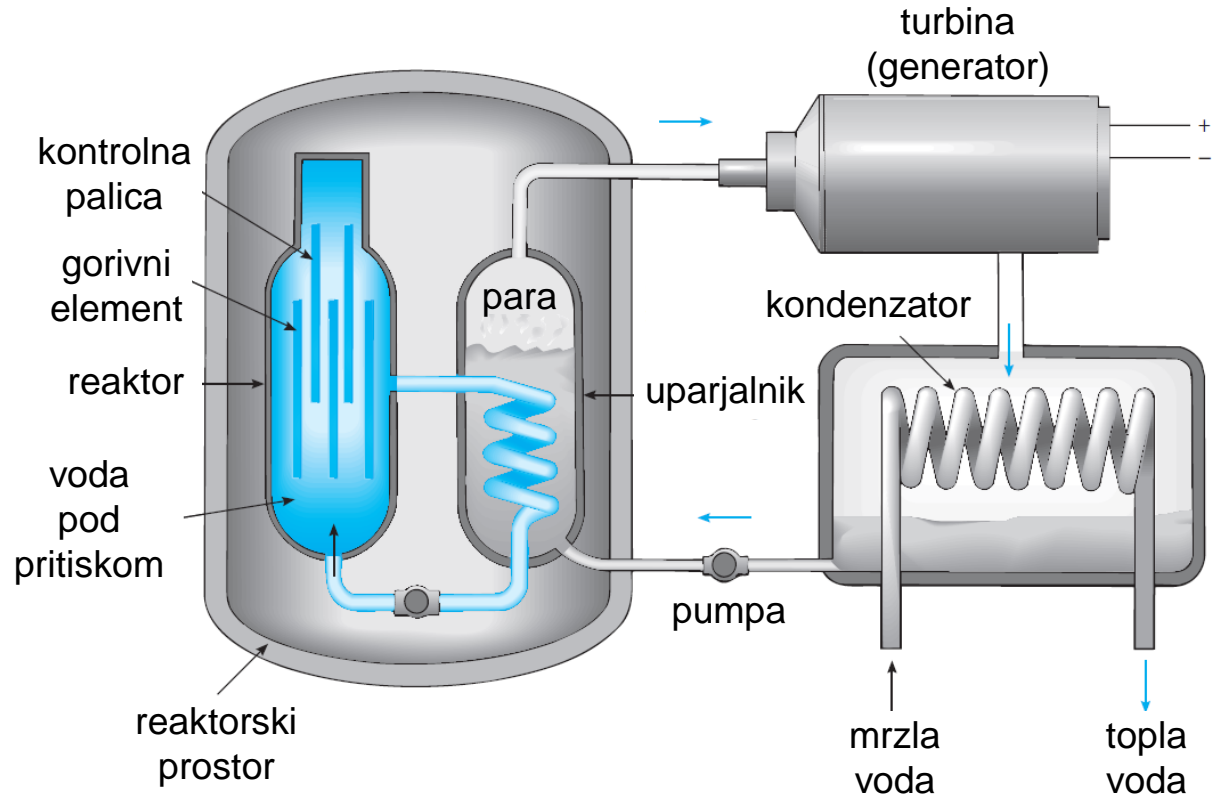

Jedrski reaktor TRIGA (IJS)

SIMULACIJA

Vir: internet; povzeto po Serway, Moses & Moyer, Modern Physics, Thomson Learning, 2005

10.6 Razcep in zlivanje jeder

➤ Zlivanje jeder (fuzija): zvezde

vodikov cikel:

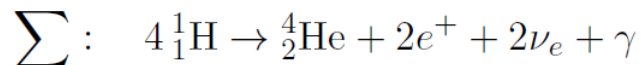
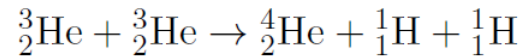
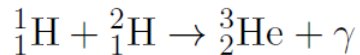
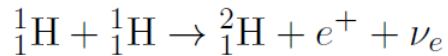

$$(Q = 26,3 \text{ MeV})$$



Vir: internet

ogljiko-dušikov cikel:

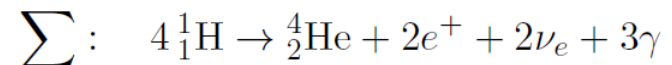
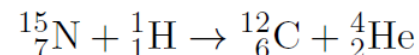
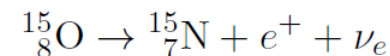
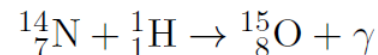
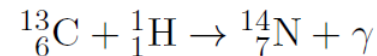
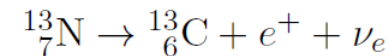
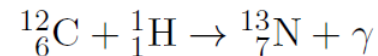

$$(Q = 25,1 \text{ MeV})$$

10.6 Razcep in zlivanje jader

➤ Fuzijski reaktor:

➤ Kritični parametri:

1. visoka kinetična energija (temperatura)

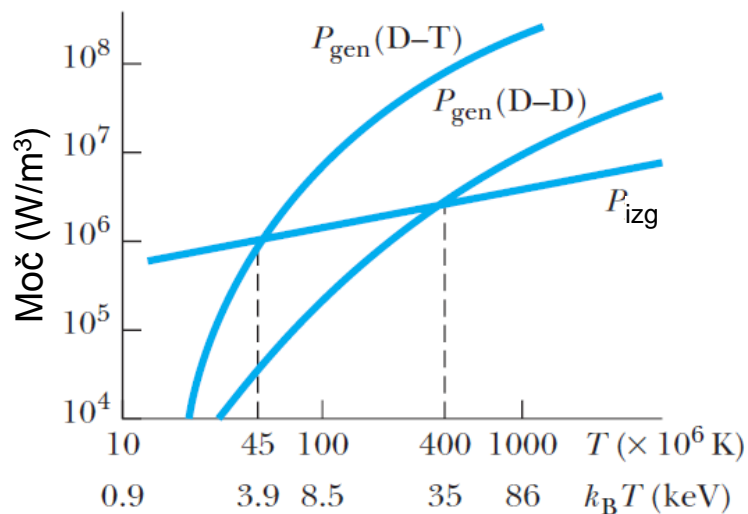

2. velika gostota jader n

3. dolg čas zadrževanja plazme τ

Lawsonov kriterij:

$$n\tau \geq 10^{20} \text{ s/m}^3 \quad (\text{D} - \text{T})$$

$$n\tau \geq 10^{22} \text{ s/m}^3 \quad (\text{D} - \text{D})$$

SIMULACIJA

Vir: internet; povzeto po Serway, Moses & Moyer, Modern Physics, Thomson Learning, 2005

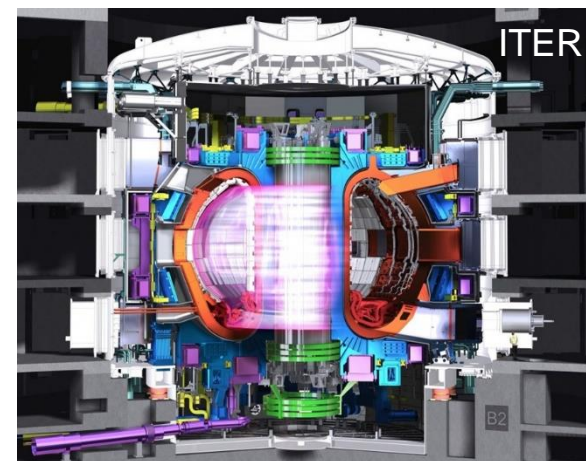
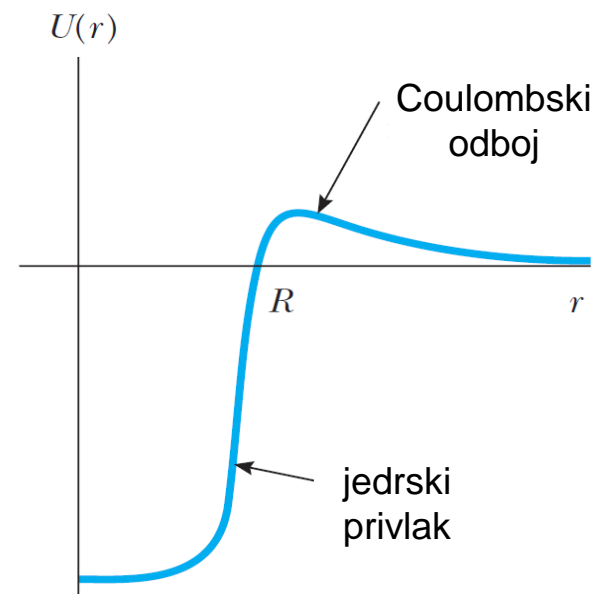

10.7 Posledice, meritve in uporaba radioakt. sevanja

➤ Merilniki sevanja:

1. ionizacijska celica
2. scintilacijski števec

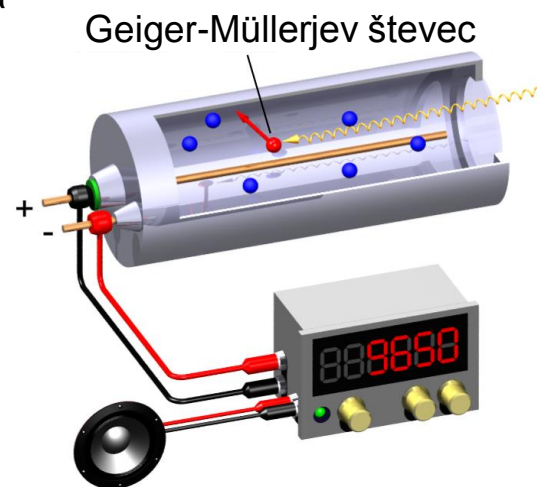
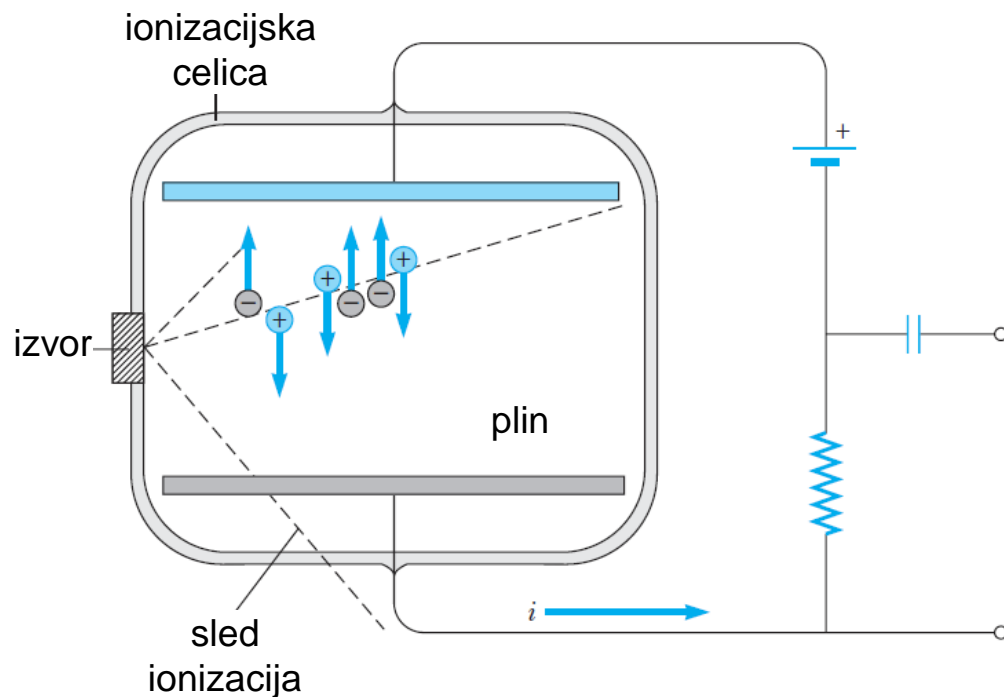
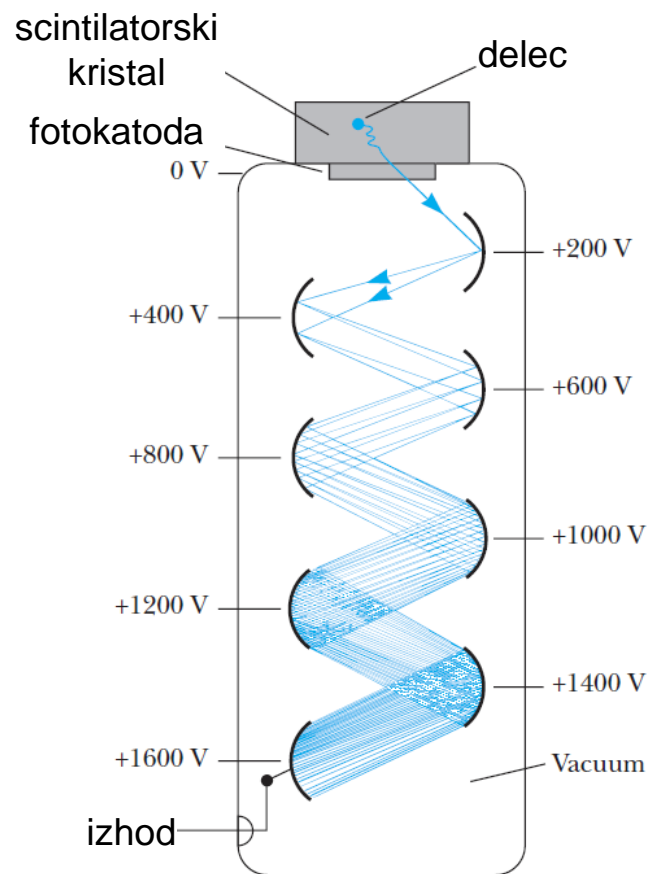

Vir: internet; povzeto po Serway, Moses & Moyer, Modern Physics, Thomson Learning, 2005

10.7 Posledice, meritve in uporaba radioakt. sevanja

- Merilniki sevanja:
 - 3. polprevodniška dioda
 - 4. detektorji trajektorije

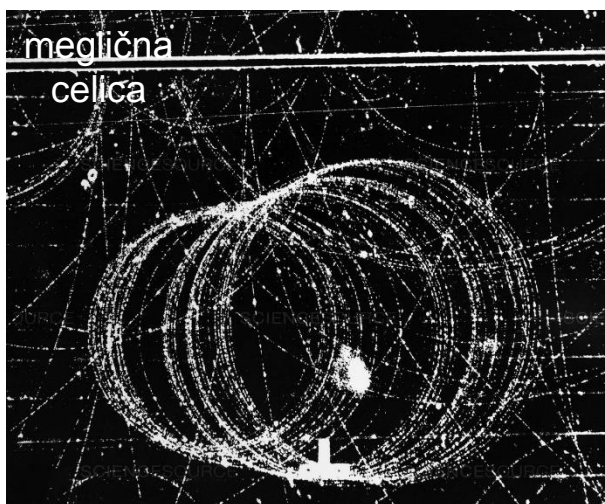
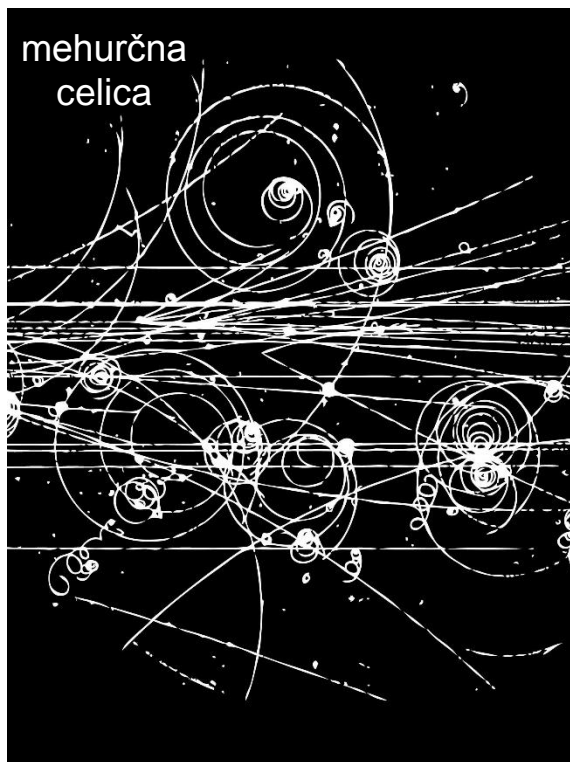
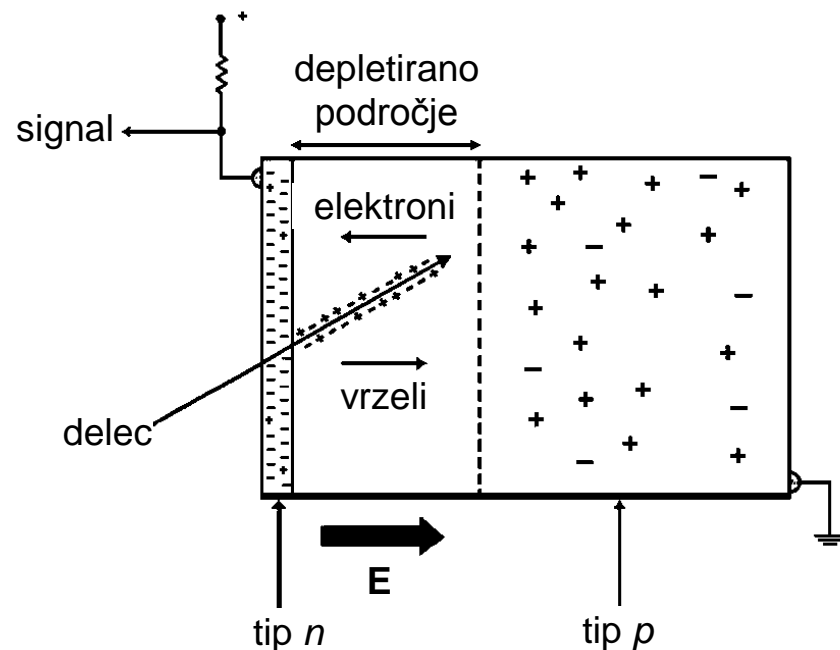

Vir: internet



10.7 Posledice, meritve in uporaba radioakt. sevanja

➤ Uporaba radioaktivnega sevanja:

1. Nevtronska aktivacija:

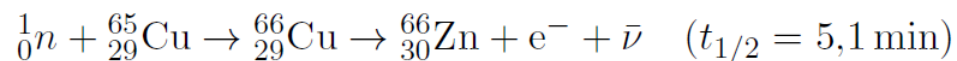

2. Sledenje radioaktivnim izotopom:

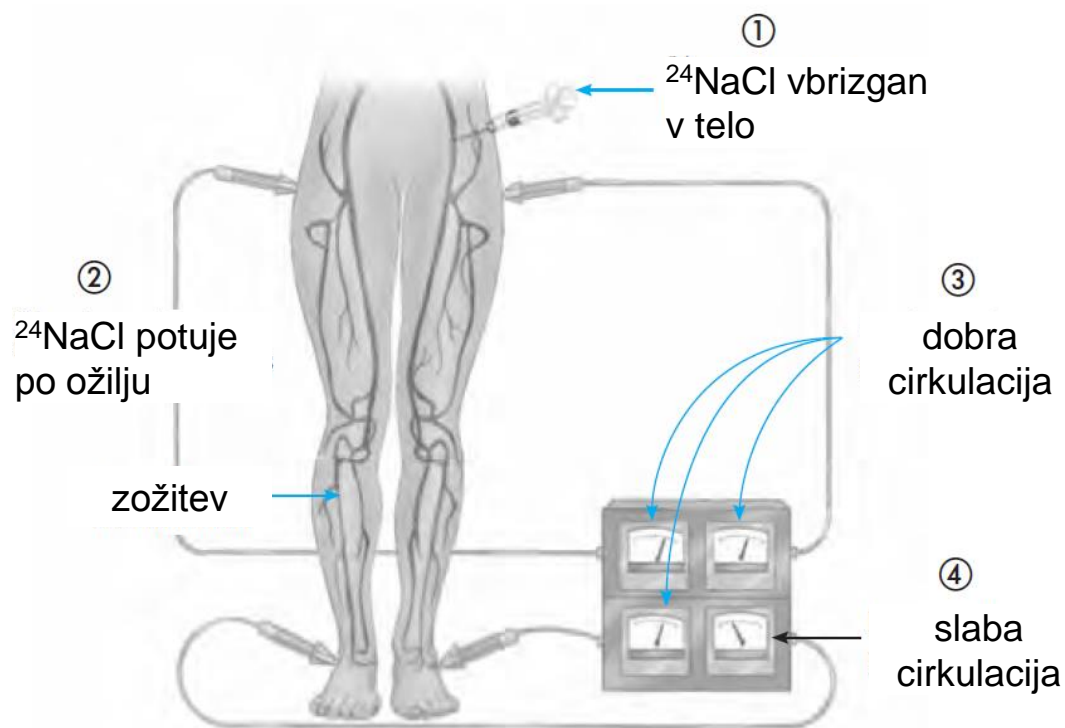

3. Radiacijska terapija:



4. Datiranje: razpad izotopa ${}^{14}\text{C}$

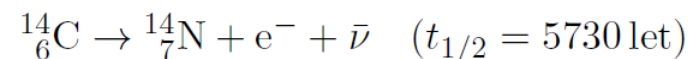

SIMULACIJA

Vir: internet; povzeto po Serway, Moses & Moyer, Modern Physics, Thomson Learning, 2005



MODERNA FIZIKA

Osnovni delci

11.1 Fundamentalne sile v naravi

➤ Sile med delci:

1. močna sila

- med kvarki in hadroni
- kratkega dosega (med hadroni)



2. elektromagnetna sila

- med nabitimi delci
- dolgega dosega



Vir: internet

3. šibka sila

- med kvarki in leptoni
- kratkega dosega



4. gravitacijska sila

- med delci z maso
- dolgega dosega



11.1 Fundamentalne sile v naravi

- Kvantna teorija polja: delci polja (umeritveni bozoni)

Interakcija (sila)	Med	Relat. jakost	τ	Doseg	Delci polja
močna	kvarki, hadroni	1	$\leq 10^{-20}$ s	kratek (~ 1 fm)	gluoni
elektromagnetna	nabiti delci	$\sim 10^{-2}$	$\sim 10^{-16}$ s	dolg (∞)	fotoni
šibka	kvarki, leptoni	$\sim 10^{-6}$	$\geq 10^{-10}$ s	kratek ($\sim 10^{-3}$ fm)	šibki bozoni W^\pm, Z^0
gravitacijska	vsi delci	$\sim 10^{-43}$?	dolg (∞)	gravitoni

- Higgsov bozon vs. graviton (kvant gravitacijskega polja):

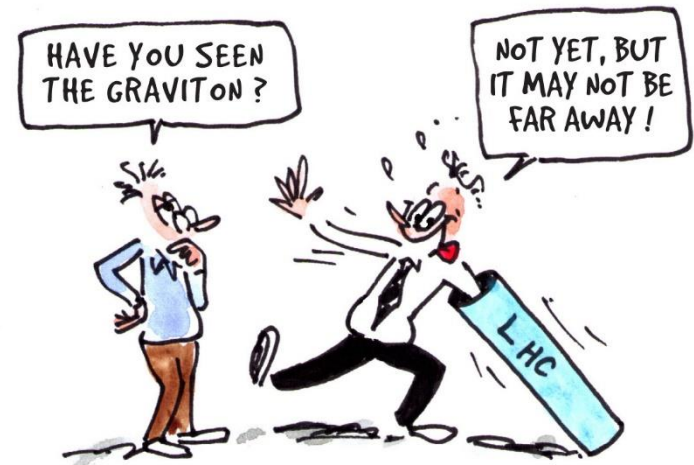

Vir: internet

11.2 Klasifikacija delcev

➤ V 1930-ih so poznali 6 delcev:

- proton
- nevtron
- elektron
- foton
- nevtrino
- pozitron

The Nobel Prize in Physics 1936



Victor Franz Hess
Prize share: 1/2



Carl David
Anderson
Prize share: 1/2

The Nobel Prize in Physics 1936 was divided equally between Victor Franz Hess *"for his discovery of cosmic radiation"* and Carl David Anderson *"for his discovery of the positron"*.

Vir: internet

➤ Pospeševalniki: novi delci

- mezoni π
- mioni

The Nobel Prize in Physics 1950



Cecil Frank Powell
Prize share: 1/1

The Nobel Prize in Physics 1950 was awarded to Cecil Powell *"for his development of the photographic method of studying nuclear processes and his discoveries regarding mesons made with this method"*.

11.2 Klasifikacija delcev

➤ Delce delimo na:

1. HADRONI

(močna sila)

a) mezoni

b) barioni

2. LEPTONI

(elektromagnetna
in šibka sila)

➤ Antidelci:

The Nobel Prize in Physics 1959



Emilio Gino Segrè
Prize share: 1/2



Owen Chamberlain
Prize share: 1/2

The Nobel Prize in Physics 1959 was awarded jointly to Emilio Gino Segrè and Owen Chamberlain "for their discovery of the antiproton"

Kategorija	Ime	Simbol	Anti-delec	Masa (MeV/c ²)	B	L _e	L _μ	L _τ	S	τ (s)	τ	Osnovni razpad
HADRONI												
Mezoni	Pion	π^+	π^-	139.6	0	0	0	0	0	2.60×10^{-8}	$\mu^+ \nu_\mu$	
		π^0	Self	135.0	0	0	0	0	0	0.83×10^{-16}	2γ	
	Kaon	K^+	K^-	493.7	0	0	0	0	+1	1.24×10^{-8}	$\mu^+ \nu_\mu$	
		K_S^0	\bar{K}_S^0	497.7	0	0	0	0	+1	0.89×10^{-10}	$\pi^+ \pi^0$	
		K_L^0	\bar{K}_L^0	497.7	0	0	0	0	+1	5.2×10^{-8}	$\pi^+ \pi^-$	
											$2\pi^0$	
Eta	η	Self	548.8	0	0	0	0	0	$<10^{-18}$	$\pi^\pm e^\mp \bar{\nu}_e$		
	η'	Self	958	0	0	0	0	0	2.2×10^{-21}	$3\pi^0$		
Barioni	Proton	p	\bar{p}	938.3	+1	0	0	0	0	Stable	$\pi^\pm \mu^\mp \bar{\nu}_\mu$	
	Neutron	n	\bar{n}	939.6	+1	0	0	0	0	624	$2\gamma, 3\pi^0$	
	Lambda	Λ^0	$\bar{\Lambda}^0$	1115.6	+1	0	0	0	-1	2.6×10^{-10}	$\eta \pi^+ \pi^-$	
		Sigma	Σ^+	$\bar{\Sigma}^-$	1189.4	+1	0	0	0	-1	0.80×10^{-10}	$p e^- \bar{\nu}_e$
		Σ^0	$\bar{\Sigma}^0$	1192.5	+1	0	0	0	-1	6×10^{-20}	$p \pi^0, n \pi^+$	
		Σ^-	$\bar{\Sigma}^+$	1197.3	+1	0	0	0	-1	1.5×10^{-10}	$\Lambda^0 \gamma$	
	Delta	Δ^{++}	$\bar{\Delta}^{--}$	1230	+1	0	0	0	0	0	6×10^{-24}	$n \pi^-$
		Δ^+	$\bar{\Delta}^0$	1231	+1	0	0	0	0	0	6×10^{-24}	$p \pi^+$
		Δ^0	$\bar{\Delta}^0$	1232	+1	0	0	0	0	0	6×10^{-24}	$p \pi^0, n \pi^+$
		Δ^-	$\bar{\Delta}^+$	1234	+1	0	0	0	0	0	6×10^{-24}	$n \pi^0, p \pi^-$
Xi	Ξ^0	$\bar{\Xi}^0$	1315	+1	0	0	0	-2	2.9×10^{-10}	$n \pi^-$		
	Ξ^-	$\bar{\Xi}^+$	1321	+1	0	0	0	-2	1.64×10^{-10}	$\Lambda^0 \pi^0$		
Omega	Ω^-	$\bar{\Omega}^+$	1672	+1	0	0	0	-3	0.82×10^{-10}	$\Lambda^0 \pi^-$		
LEPTONI												
LEPTONI	Electron	e^-	e^+	0.511	0	+1	0	0	0	Stable	$\Xi^- \pi^0, \Xi^0 \pi^-, \Lambda^0 K^-$	
	Electron-neutrino	ν_e	$\bar{\nu}_e$	$<2.8 \times 10^{-6}$	0	+1	0	0	0	Stable		
	Muon	μ^-	μ^+	105.7	0	0	+1	0	0	2.19×10^{-6}	$e^- \bar{\nu}_e \nu_\mu$	
	Muon-neutrino	ν_μ	$\bar{\nu}_\mu$	$<3.5 \times 10^{-6}$	0	0	+1	0	0	Stable		
	Tau	τ^-	τ^+	1784	0	0	0	+1	0	3.3×10^{-13}	$\mu^- \bar{\nu}_\mu \nu_\tau$	
	Tau-neutrino	ν_τ	$\bar{\nu}_\tau$	$<8.4 \times 10^{-6}$	0	0	0	+1	0	Stable	$e^- \bar{\nu}_e \nu_\tau$	

Vir: internet; povzeto po Serway, Moses & Moyer, Modern Physics, Thomson Learning, 2005

11.2 Klasifikacija delcev

Nevtrinske oscilacije:

- Deficit sončnih elektronskih nevtrinov

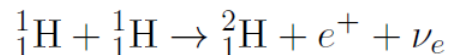

- Mešanje nevtrinov:

$$|\nu_\alpha\rangle = \sum_i U_{\alpha,i}^* |\nu_i\rangle$$

dober okus matrika PMNS dobra masa

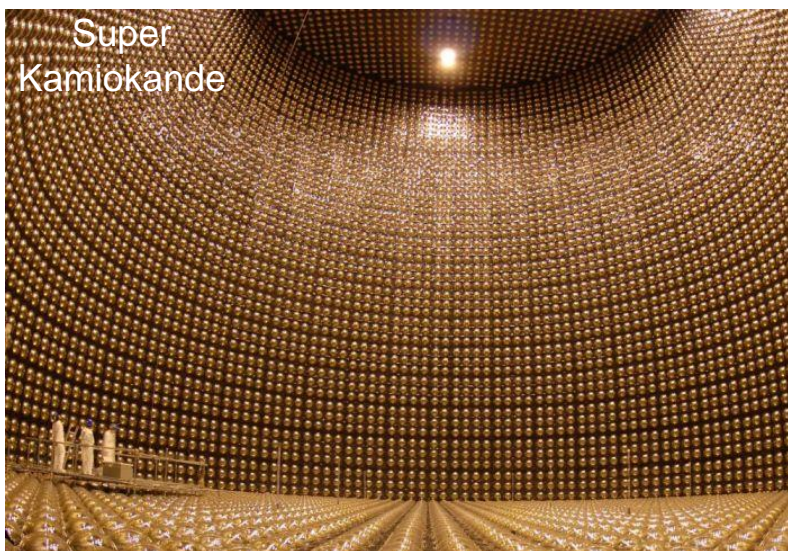

Vir: internet

The Nobel Prize in Physics 2015



Photo: A. Mahmoud
Takaaki Kajita
Prize share: 1/2



Photo: A. Mahmoud
Arthur B. McDonald
Prize share: 1/2

The Nobel Prize in Physics 2015 was awarded jointly to Takaaki Kajita and Arthur B. McDonald *"for the discovery of neutrino oscillations, which shows that neutrinos have mass"*



11.3 Kvarkovska sestava hadronov

➤ Kvarkovski model:

a) mezon = kvark/antikvark

b) barioni = 3 kvarki

vezivo = gluoni

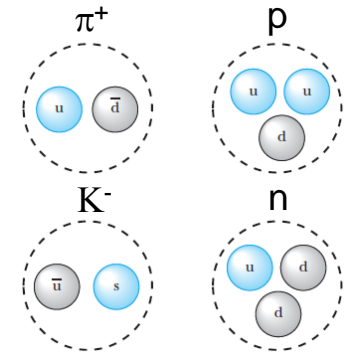
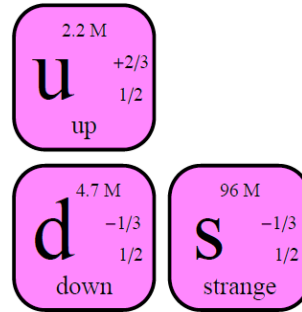

The Nobel Prize in Physics 1969



Murray Gell-Mann
Prize share: 1/1

The Nobel Prize in Physics 1969 was awarded to Murray Gell-Mann "for his contributions and discoveries concerning the classification of elementary particles and their interactions".

The Nobel Prize in Physics 1990



Jerome I. Friedman
Prize share: 1/3

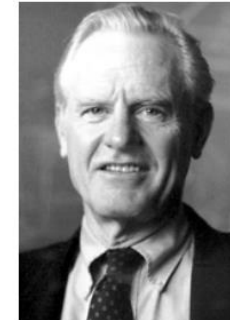

Henry W. Kendall
Prize share: 1/3



Photo: T. Nakashima
Richard E. Taylor
Prize share: 1/3

The Nobel Prize in Physics 1990 was awarded jointly to Jerome I. Friedman, Henry W. Kendall and Richard E. Taylor "for their pioneering investigations concerning deep inelastic scattering of electrons on protons and bound neutrons, which have been of essential importance for the development of the quark model in particle physics".

Vir: internet; ; povzeto po Serway, Moses & Moyer, Modern Physics, Thomson Learning, 2005

11.3 Kvarkovska sestava hadronov

➤ Barionski oktet (spin 1/2)

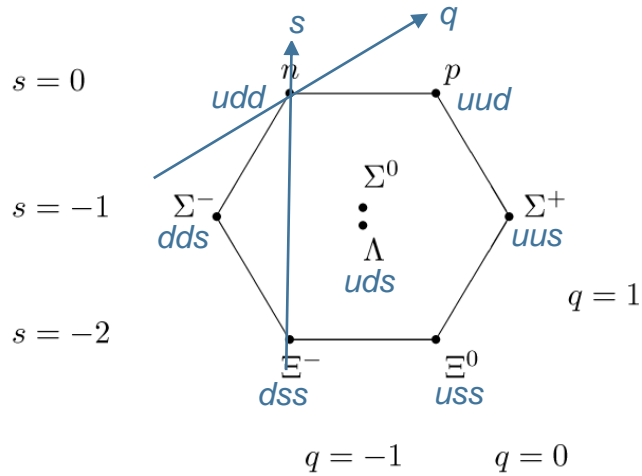

➤ Barionski deкупlet (spin 3/2)

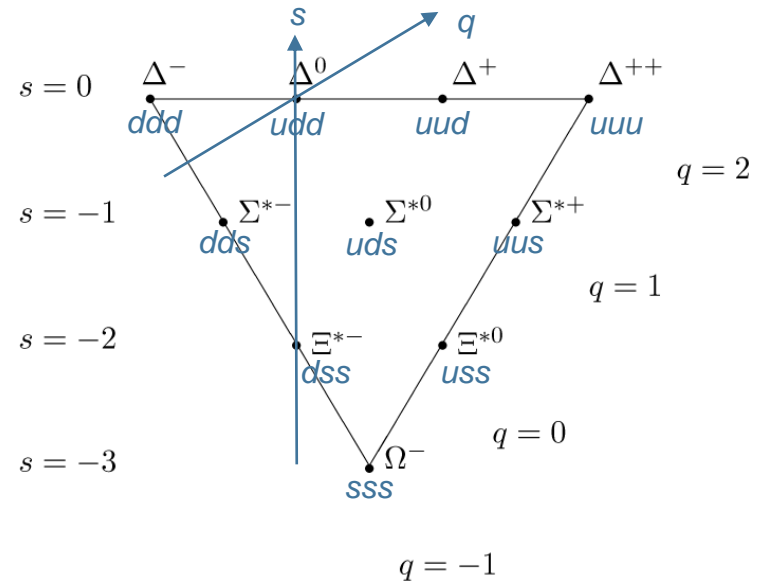

➤ Mezonski nonet = oktet + singlet (spin 0)

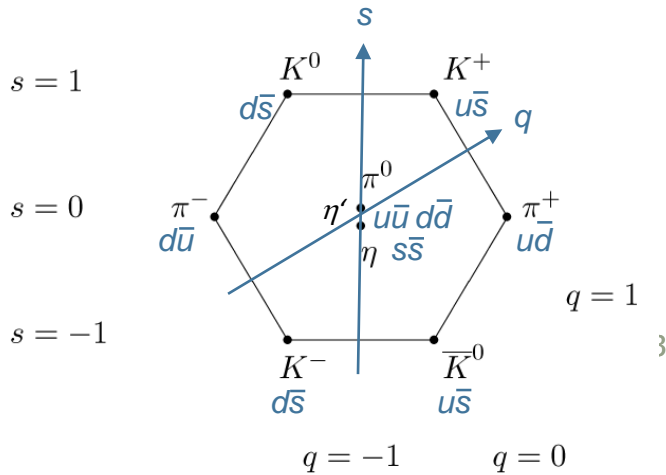

11.3 Kvarkovska sestava hadronov

➤ 3 družine kvarkov:

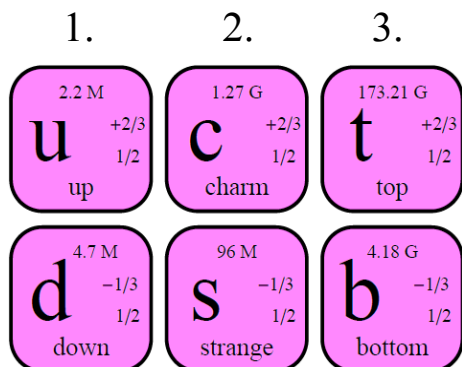

The Nobel Prize in Physics 2008



Photo: University of Chicago
Yoichiro Nambu
 Prize share: 1/2

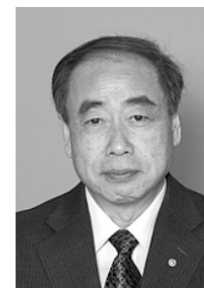

© The Nobel Foundation
 Photo: U. Montan
Makoto Kobayashi
 Prize share: 1/4



© The Nobel Foundation
 Photo: U. Montan
Toshihide Maskawa
 Prize share: 1/4

The Nobel Prize in Physics 2008 was divided, one half awarded to Yoichiro Nambu "for the discovery of the mechanism of spontaneous broken symmetry in subatomic physics", the other half jointly to Makoto Kobayashi and Toshihide Maskawa "for the discovery of the origin of the broken symmetry which predicts the existence of at least three families of quarks in nature".

Kvark	Simbol	Spin	Naboj	Barionsko število	Čudnost	Šarm	Dno	Vrh
Up	u	$\frac{1}{2}$	$+\frac{2}{3}e$	$\frac{1}{3}$	0	0	0	0
Down	d	$\frac{1}{2}$	$-\frac{1}{3}e$	$\frac{1}{3}$	0	0	0	0
Strange	s	$\frac{1}{2}$	$-\frac{1}{3}e$	$\frac{1}{3}$	-1	0	0	0
Charmed	c	$\frac{1}{2}$	$+\frac{2}{3}e$	$\frac{1}{3}$	0	+1	0	0
Bottom	b	$\frac{1}{2}$	$-\frac{1}{3}e$	$\frac{1}{3}$	0	0	+1	0
Top	t	$\frac{1}{2}$	$+\frac{2}{3}e$	$\frac{1}{3}$	0	0	0	+1

Vir: internet



11.3 Kvarkovska sestava hadronov

- Kvantna kromodinamika: barvni naboj (močna sila)

$$\psi = \psi_r \psi_S \psi_o \psi_{bn}$$

- Mešanje kvarkov (šibka sila): matrika Cabbibo-Kobayashi-Maskawa

$$|V_{CKM}| = \begin{bmatrix} |V_{ud}| & |V_{us}| & |V_{ub}| \\ |V_{cd}| & |V_{cs}| & |V_{cb}| \\ |V_{td}| & |V_{ts}| & |V_{tb}| \end{bmatrix}$$

$$= \begin{bmatrix} 0,97428 & 0,2253 & 0,00347 \\ 0,2252 & 0,97345 & 0,0410 \\ 0,00862 & 0,0403 & 0,999152 \end{bmatrix}$$

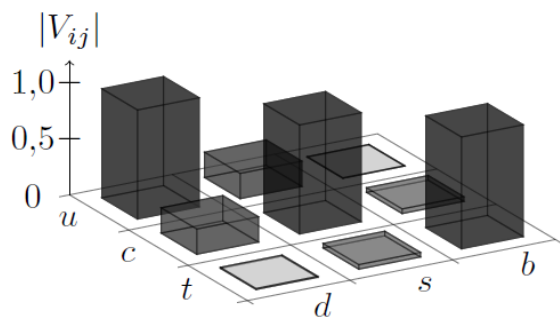

Vir: internet

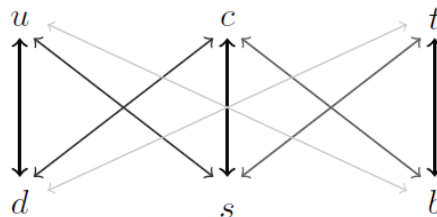

The Nobel Prize in Physics 1965



Sin-Itiro Tomonaga
Prize share: 1/3



Julian Schwinger
Prize share: 1/3



Richard P. Feynman
Prize share: 1/3

The Nobel Prize in Physics 1965 was awarded jointly to Sin-Itiro Tomonaga, Julian Schwinger and Richard P. Feynman "for their fundamental work in quantum electrodynamics, with deep-ploughing consequences for the physics of elementary particles".

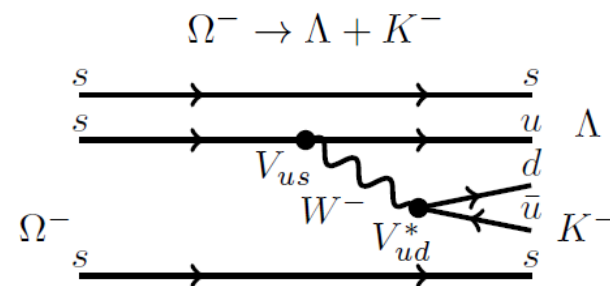

11.4 Standardni model

- Elektrošibka interakcija:

The Nobel Prize in Physics 1984



Carlo Rubbia
Prize share: 1/2



Simon van der Meer
Prize share: 1/2

The Nobel Prize in Physics 1984 was awarded jointly to Carlo Rubbia and Simon van der Meer *"for their decisive contributions to the large project, which led to the discovery of the field particles W and Z, communicators of weak interaction"*

Vir: internet

The Nobel Prize in Physics 1979



Sheldon Lee
Glashow
Prize share: 1/3



Abdus Salam
Prize share: 1/3



Steven Weinberg
Prize share: 1/3

The Nobel Prize in Physics 1979 was awarded jointly to Sheldon Lee Glashow, Abdus Salam and Steven Weinberg *"for their contributions to the theory of the unified weak and electromagnetic interaction between elementary particles, including, inter alia, the prediction of the weak neutral current"*.

11.4 Standardni model

➤ Standardni model:

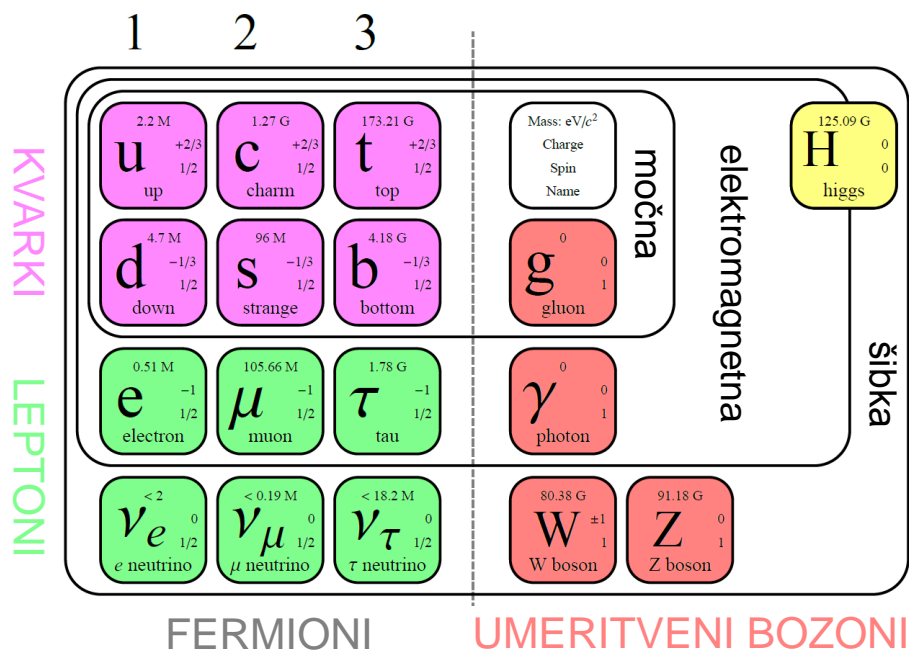

The Nobel Prize in Physics 2013



Photo: A. Mahmoud
François Englert
Prize share: 1/2



Photo: A. Mahmoud
Peter W. Higgs
Prize share: 1/2

The Nobel Prize in Physics 2013 was awarded jointly to François Englert and Peter W. Higgs *"for the theoretical discovery of a mechanism that contributes to our understanding of the origin of mass of subatomic particles, and which recently was confirmed through the discovery of the predicted fundamental particle, by the ATLAS and CMS experiments at CERN's Large Hadron Collider"*

SIMULACIJA

Vir: internet

11.5 Ohranitveni zakoni in Feynmanovi diagrami

➤ Ohranitveni zakoni:

Zvezne transformacije:

1. ohranitev energije (premik časa)
2. ohranitev gibalne količine (premik v prostoru)
3. ohranitev vrtilne količine (zasuk v prostoru)

Empirični zakoni:

7. ohranitev barionskega števila
8. ohranitev leptonskih števil
9. ohranitev okusnega naboja
10. ohranitev naboja

➤ Šibka sila krši: 4, 5, 6, 9

Nezvezne transformacije:

4. ohranitev parnosti (inverzija prostora)
5. invariantnost na inverzijo prostora
6. Invariantnost na konjugacijo naboja

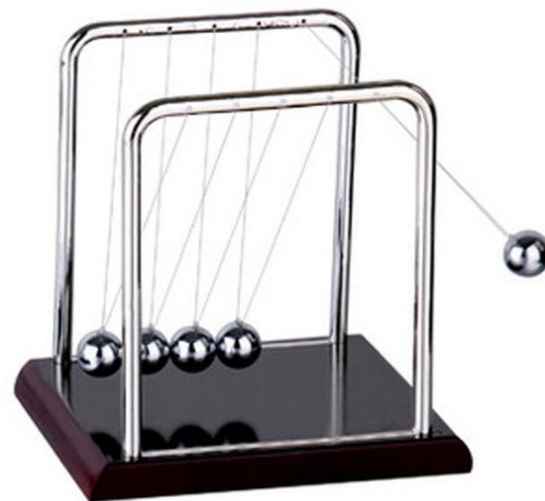

11.5 Ohranitveni zakoni in Feynmanovi diagrami

➤ Feynmanovi diagrami:

1. svetovnice
2. temena

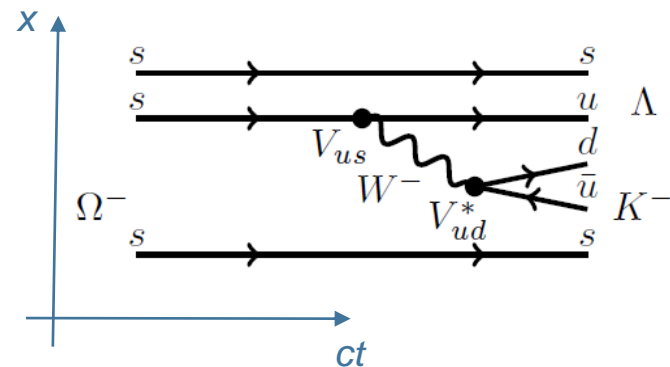

Elektromagnetna sila:

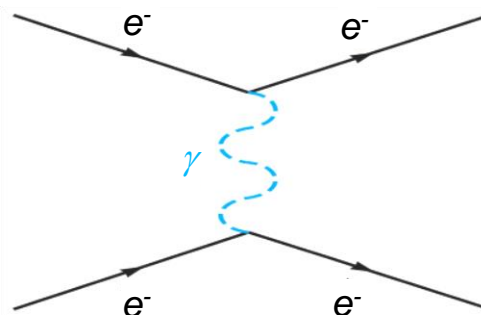

Močna sila:

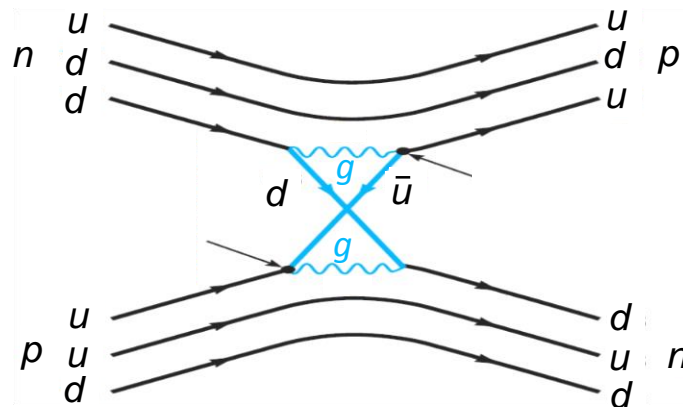
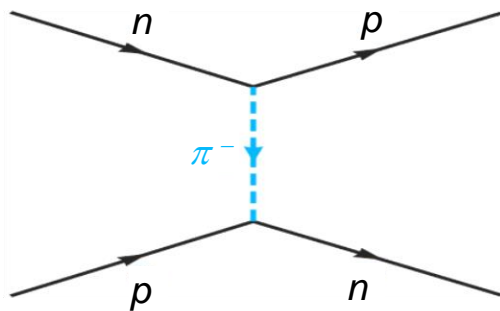

11.6 Produkcija osnovnih delcev

➤ Resonance v sipalnem preseku:

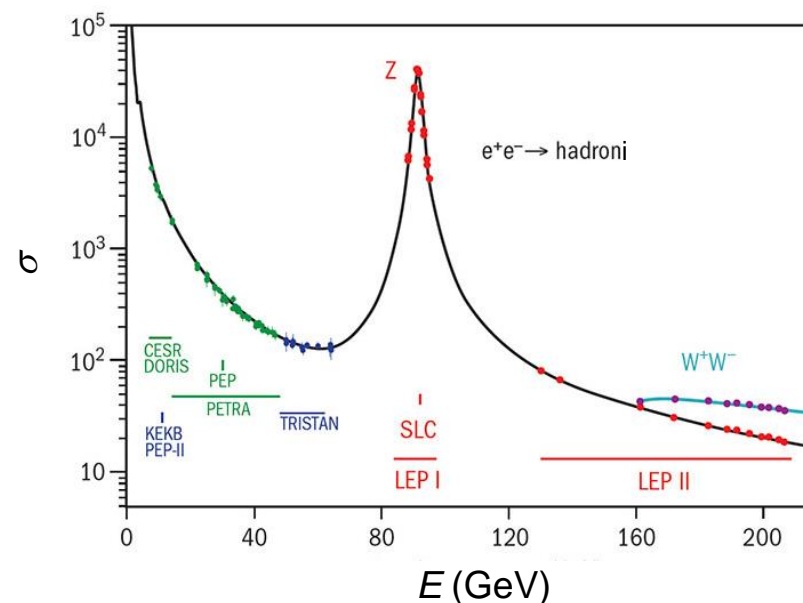

➤ Pospeševalniki, trkalniki

Pospeševalnik	Kraj	Obratovanje	Pospešeni delci	Maksimalna E GeV	Svetlost, $10^{30} \text{ cm}^{-2} \text{ s}^{-1}$	Premer km
VEPP-2000	INP, Novosibirsk, Russia	2006	e^+e^-	1.0	100	0.024
VEPP-4M	INP, Novosibirsk, Russia	1994	e^+e^-	6	20	0.366
BEPC II	IHEP, Beijing, China	2008	e^+e^-	3.7	700	0.240
DAFNE	Frascati, Italy	1999	e^+e^-	0.7	436 ^[12]	0.098
KEKB/SuperKEKB	KEK, Tsukuba, Japan	1999	e^+e^-	8.5 (e-), 4 (e+)	21100	3.016
RHIC	BNL, United States	2000	pp, Au-Au, Cu-Cu, d-Au	100/n	10, 0.005, 0.02, 0.07	3.834
LHC	CERN	2008	pp, Pb-Pb, p-Pb, Xe-Xe	6500 (plan 7000), 2560/n (plan 2760/n)	20000 ^[13] , 0.003, 0.9, ~0.0002	26.659

Vir: internet

11.7 Onstran standardnega modela

➤ Velika teorija poenotenja = elektrošibka teorija + kvantna kromodinamika

- velika poenotena sila
- leptokvark (kvark, lepton)
- supersimetrija (fermion ↔ bozon)

➤ Teorija strun

- poenotena vseh štirih fundamentalnih sil
- delec = vibracija strune
- 10 dimenzij
- več verzij teorije superstrun

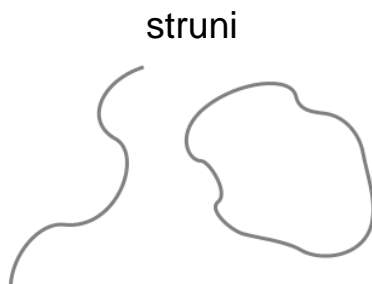
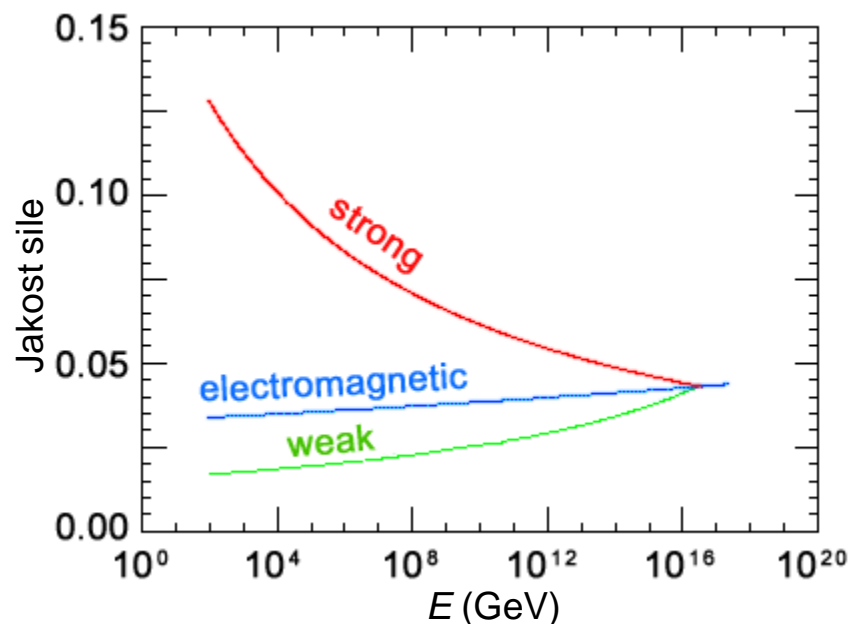

„kompaktifikacija“

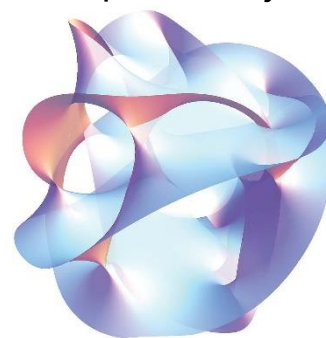

Literatura

Teorija:

- J. Strnad, *Fizika III, 3. izdaja* (DMFA založništvo, Ljubljana, 2018)
- J. Strnad, *Fizika IV, 3. izdaja* (DMFA založništvo, Ljubljana, 2018)
- J. Bernstein, P. M. Fishbane, S. Gasiorowicz, *Modern Physics* (Pearson Prentice Hall, Upper Saddle River 2000)
- R. A. Serway, C. J. Moses, C. A. Moyer, *Modern Physics* (Thomson Learning, Belmont, 2005)
- P. A. Tipler, L. A. Llewellyn, *Modern Physics* (W. H. Freeman and Company, New York, 2012)

Naloge:

- A. Zorko, M. Nemevšek, N. Košnik, M. Lubej, *Zbirka rešenih nalog iz moderne fizike* (DMFA založništvo, Ljubljana, 2018)

Zgodovina:

- J. Baggott, *The Quantum Story: A History in 40 Moments* (Oxford University Press, Oxford, 2011)